

Since 1982

MOBILETRON™
REGITAR USA™



Mobiletron Electronics Co., Ltd.

No.85, Sec.4, Chung-Ching Rd., Ta-Ya District,
Taichung 428, Taiwan
Tel : +886 (0)4 2560 7389
E-mail : mobiletron@more.com.tw
www.mobiletron.com

Mobiletron UK Ltd.

Unit 80 Roman Way Industrial Estate, Longridge Rd
Preston, Lancashire, PR2 5BE, England
Tel : +44 (0)1772 693780
E-mail : sales@mobiletron.co.uk
www.mobiletron.co.uk

Regitar USA, Inc.

2575 Container Drive, Montgomery,
AL 36109 USA
Tel : +1 334 244-1885
E-mail : info@regitar.com
www.regitar.com

Mobiletron Electronics (Ningbo) Co., Ltd.

C6, Economy Development Zone A, Far East Industry Park,
Yu Yao City, Zhe Jiang Province, China
Tel : +86 (0) 574 6276 0669

MOBILETRON™ REGITAR USA™

CHARGING SYSTEMS

AUTOMOTIVE ELECTRONICS

CHARGING SYSTEMS

- *Voltage Regulators*
- *Rectifiers*
- *Diodes*

2018/2019



IATF 16949:2016
Quality Management System



Edition No. 15



Headquarters (Taiwan)

Since 1982

MOBILETRON™

REGITAR USA™



Mobiletron (Taiwan)
• Taichung



LEADING THE WAY IN ELECTRONIC MANUFACTURING

1982

1988

INNOVATION

- The Mobiletron ethos is to design products with the customer in mind.
- Over 36 years' experience of automotive industry knowledge and manufacturing committed to the best solution.

RELIABILITY

- Reliable TQM system for quality assurance.
- IATF16949/ISO9000/ISO14000 certified and RoHS/WEEE/REACH/ELV compliant.

SERVICE

- Our advanced processing systems ensure our customers receive the best possible service.
- Flexible production system and delivery service ensures timely and efficient deliveries.

ENVIRONMENT POLICY

- Continuously focus on the best ways to protect the environment using eco-considerate products.
- Mobiletron uses recycling technologies that also increase product quality.



Regitar (USA)
• Alabama

Certifications

- 1992 ISO9002 Certified
- 1997 QS9000 Certified
- 1999 ISO9001 Certified
- 2000 ISO14001 Certified
- 2006 TS16949 Certified
- 2008 QC080000 Certified
- 2016 CCMI Certified
- 2018 IATF16949 Certified





Mobiletron (China)
• Ningbo



Durofix (USA)
• California

IATF16949 Certified

1995

2009

2000

2001

2018



Mobiletron (UK)
• Preston

Public (IPO) Company in Taiwan



RAC (Taiwan)
• Tao Yuan



Engine Parts
Ignition System, Charging System, Sensors



(Electric Vehicles)
Power Module & Motor Controller



Internet of Vehicle
HD cameras, Telematics, Gateway



(Electric Vehicles)
BMS & Battery Pack



ADAS
Cameras, AVM, E-Mirror, TPMS



TPMS

- Engine Management Parts
- Advanced Driving Assistance System (ADAS)
- Battery Management System (BMS)

ENGINE PARTS

Engine Management Sensors

Charging Systems

Ignition Systems

Advance Driving Assistance System (ADAS)

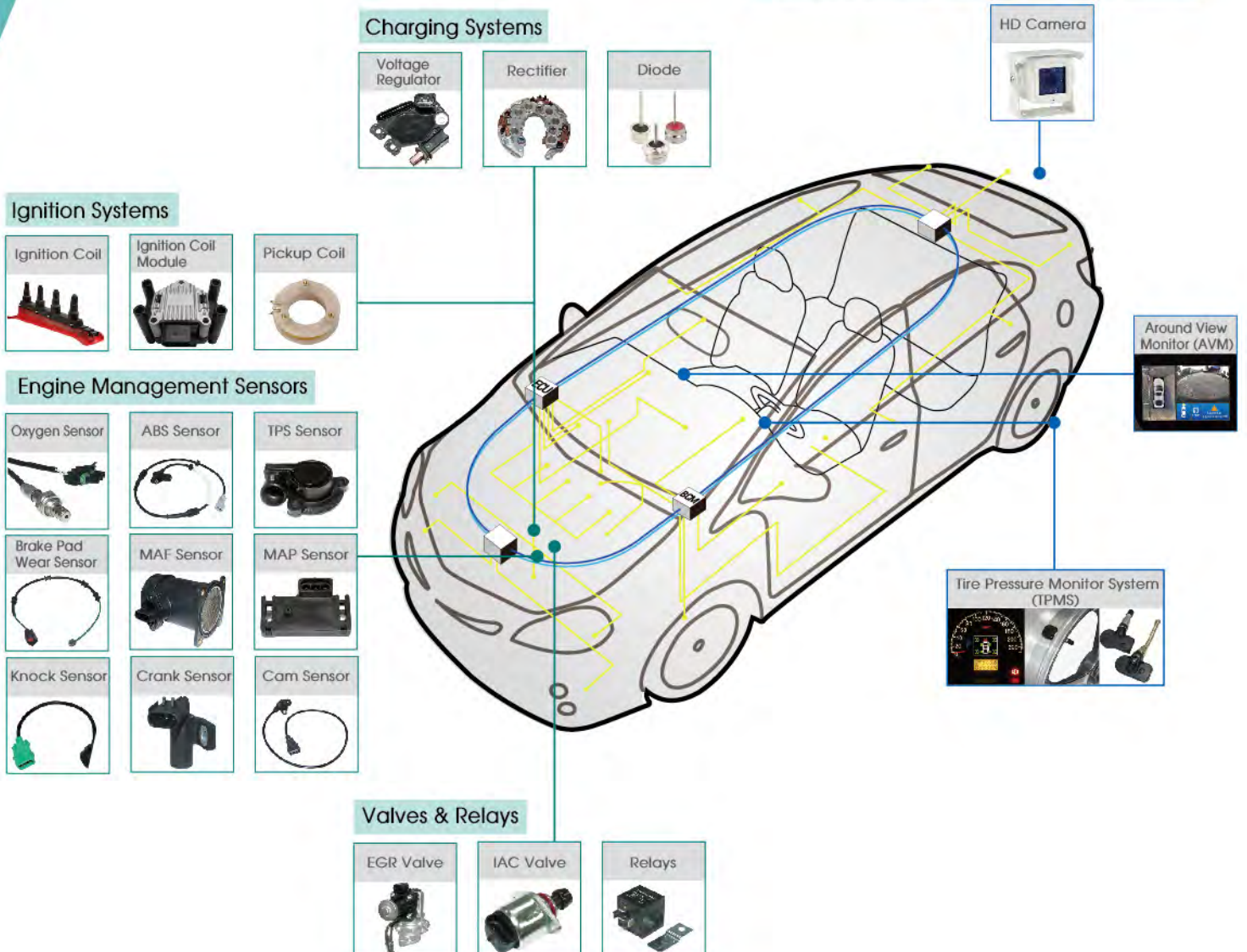

THE COMPLETE TPMS SOLUTION

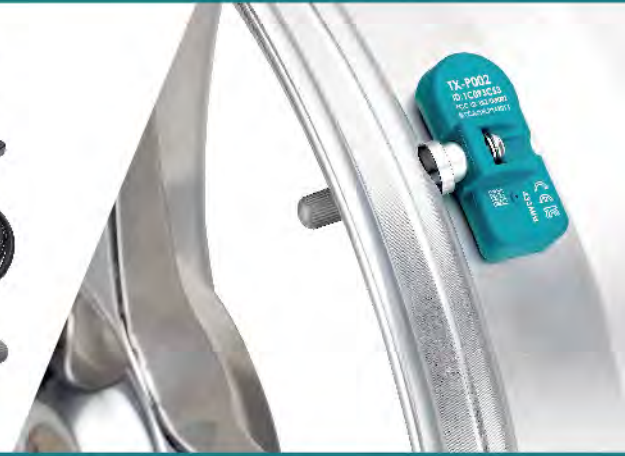

COMBI SENSOR

More details of TPMS : www.mobiletron.com/TPMS/



BATTERY MANAGEMENT SYSTEM (BMS) ENERGY STORAGE SYSTEM (ESS) ELECTRIC VEHICLES



- Battery Protection
- SOC Calculation
- Balance Function etc.

Applications

Energy Storage Container



12-meter Low-Floor E-Bus



7-meter 20-Seater E-Bus



LIMITED WARRANTY

1. Mobletron provides 14 months warranty for the products purchased from the day of shipment In accordance with the Date Code (Shipping Code) marked on each product.
2. During warranty period, Mobletron will replace any parts which is found to be defective while In NORMAL USE and PROPER INSTALLATION.
3. Mobletron is only liable for the replacement of the parts purchased from us. Any additional claims such as TRANSPORTATION, REPAIR or any CONSEQUENTIAL DAMAGES are excepted from our warranty.
4. The replacement will not be responsible for any parts proved to be damaged by IMPROPER INSTALLATION, or found out TAMPERED, MODIFICATION ABUSED, OR MISUSED after our analysis.
5. Any warranty claim is requested to return the defective parts before the tenth of first month every quarter for analysis and replacement.
6. Defective parts must be returned to Mobletron for analysis IF REQUIRED..
7. Production Code and Date Code (Shipping Code) marked on our products are recognized as follows:

- **Production Code:** for tracing the quality records



- **Date Code (Shipping Code):** for identifying the validity of warranty

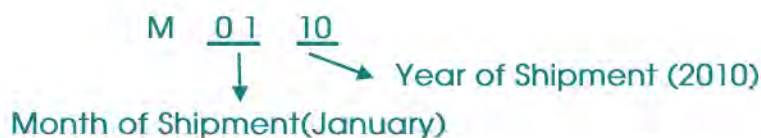

PRODUCT INDEX

Part No.	Page	Part No.	Page	Part No.	Page	Part No.	Page	Part No.	Page
BH-H02	2	RB-171HV	148	RB-78H	155	RD-29	162	RH-03	180
BH-M01	3	RB-172H	148	RB-78HA	155	RD-30	162	RH-03C	180
BH-M03	3	RB-174HD	148	RB-80H	155	RD-31	162	RH-04	181
BH-ND01	1	RB-175HD	148	RB-80HA	155	RD-31H	162	RH-04C	181
BH-ND03	1	RB-178H	148	RB-81H	156	RD-32	159	RH-04N	181
BH-ND06	1	RB-179HV	148	RB-82H	156	RD-33	163	RH-08C	181
BH-ND08	1	RB-17H	148	RB-83H	156	RD-33HD	163	RH-09C	181
BH-ND10	1	RB-180HV	149	RB-84H	156	RD-35	163	RH-102	181
BH-ND11	1	RB-181HD	149	RB-85H	156	RD-35A	163	RH-103	181
BH-ND12	1	RB-184HV	149	RB-87H	156	RD-36	163	RH-104	181
RB-01HA	140	RB-185HV	149	RB-926H	156	RD-37	163	RH-10C	182
RB-02H	140	RB-187H	149	RB-929H	156	RD-39H	163	RH-111	182
RB-03HA	140	RB-188H	149	RB-929HV	156	RD-40H	163	RH-113	182
RB-04H	140	RB-189H	149	RB-93H	157	RD-40HA	163	RH-115	182
RB-05H	141	RB-18H	150	RB-952H	157	RD-41	163	RH-116	182
RB-06HA	141	RB-190H	150	RB-954H	157	RD-44	163	RH-117	182
RB-07H	141	RB-194H	150	RB-96H	157	RD-95A	164	RH-119	182
RB-08H	141	RB-195H	150	RC-01HV	195	RD-95HD	164	RH-11C	182
RB-101H	141	RB-196H	150	RC-02HV	195	RD-96	164	RH-120	182
RB-105H	142	RB-197H	150	RC-03H	195	RD-97A	164	RH-121	182
RB-107H	142	RB-19H	150	RC-04H	195	RD-97B	164	RH-122	183
RB-108H	142	RB-24H	151	RC-05HV	195	RD-97D	164	RH-123	183
RB-10H	142	RB-26H	151	RC-06HV	195	RD-97HD	164	RH-126	183
RB-110H	142	RB-28H	151	RC-07HV	195	RD-97HV	164	RH-12C	183
RB-112H	142	RB-29H	151	RC-08HV	195	RD-98A	164	RH-14C	183
RB-113H	143	RB-30H	151	RC-17HD	195	RD-99	164	RH-15	183
RB-115H	143	RB-32H	151	RC-18HD	195	RF-01	176	RH-15C	183
RB-116H	143	RB-33H	151	RC-19	158	RF-02	176	RH-16C	184
RB-117H	143	RB-36H	151	RC-21N	158	RF-03	176	RH-17C	184
RB-118H	143	RB-37H	151	RC-21P	158	RF-043	176	RH-18C	184
RB-119H	143	RB-38H	151	RD-04B	159	RF-043HV	176	RH-20C	184
RB-11H	144	RB-40H	152	RD-05	159	RF-053	176	RH-21	184
RB-121H	144	RB-41H	152	RD-06	159	RF-053HV	176	RH-22	184
RB-122H	144	RB-42H	152	RD-06A	159	RF-063	176	RH-23	184
RB-123H	144	RB-43H	152	RD-06B	159	RF-063HV	177	RH-24	185
RB-124H	144	RB-46H	152	RD-07	159	RF-07H	177	RH-25	185
RB-125H	144	RB-47H	152	RD-08	159	RF-07HV	177	RH-26	185
RB-128H	145	RB-48H	152	RD-09	160	RF-08H	177	RH-27	185
RB-12H	145	RB-49H	152	RD-09H	160	RF-08HV	177	RH-27C	185
RB-130H	145	RB-50H	152	RD-10	160	RF-09H	177	RH-28	185
RB-134H	145	RB-51H	153	RD-10H	160	RF-09HV	177	RH-29	185
RB-137H	145	RB-52H	153	RD-10HV	160	RF-103	177	RH-30	186
RB-137HV	145	RB-53H	153	RD-12	160	RF-103HV	177	RH-31	186
RB-138H	145	RB-54H	153	RD-13HV	160	RF-113	177	RH-32	186
RB-13H	146	RB-55H	153	RD-14	160	RF-123	178	RH-33	186
RB-141H	146	RB-56H	153	RD-14H	160	RF-123HV	178	RH-35	186
RB-145H	146	RB-57H	153	RD-15	161	RF-124	178	RH-39C	186
RB-146H	146	RB-58H	153	RD-15H	161	RF-125	178	RH-40C	187
RB-148H	146	RB-59H	154	RD-16	159	RF-133	178	RH-43C	187
RB-14H	146	RB-60H	154	RD-17	161	RF-143	178	RH-48	187
RB-158H	146	RB-62H	154	RD-17H	161	RF-153	178	RH-49	187
RB-159H	146	RB-63H	154	RD-18H	161	RF-16HD	178	RH-50	187
RB-15H	147	RB-66H	154	RD-18HA	161	RF-16HV	178	RH-51	187
RB-160H	147	RB-67H	154	RD-20HA	161	RF-18HV	178	RH-53C	188
RB-161H	147	RB-67HA	154	RD-21	161	RF-19H	178	RH-58C	188
RB-163H	147	RB-71H	154	RD-21H	162	RF-22HV	179	RH-59C	188
RB-166H	147	RB-72H	154	RD-25A	162	RF-23W	179	RH-60	188
RB-167HV	147	RB-73H	155	RD-26	162	RH-01	180	RH-61	188
RB-168H	147	RB-74H	155	RD-26HD	162	RH-01C	180	RH-63	188
RB-16H	148	RB-75H	155	RD-27H	162	RH-02	180	RH-65	188
RB-170HD	148	RB-77H	155	RD-28H	162	RH-02C	180	RH-66	188

PRODUCT INDEX

Part No.	Page	Part No.	Page	Part No.	Page	Part No.	Page	Part No.	Page
RH-66A	188	RL-05H	196	RM-145	208	RM-233	214	RM-97HV	222
RH-67A	188	RL-06H	196	RM-146	208	RM-237	214	RM-98	222
RH-68	188	RL-07H	196	RM-147	208	RM-238	214	RM-99HV	222
RH-69	188	RL-08HV	197	RM-15	208	RM-239	214	RN-01	165
RH-70	189	RL-09H	197	RM-151	208	RM-24	214	RN-01P	165
RH-71	189	RL-10H	197	RM-152	209	RM-240	214	RN-01PL	165
RH-72	189	RL-11H	197	RM-153	209	RM-245HD	214	RN-02	165
RH-73	189	RL-12H	197	RM-154HV	209	RM-246	214	RN-03	165
RH-74A	189	RL-13	197	RM-155HV	209	RM-27	214	RN-03PL	165
RH-75	189	RL-13H	197	RM-157H	209	RM-28	214	RN-04	165
RH-76	189	RL-14	198	RM-158H	209	RM-29HV	215	RN-05	165
RH-77	189	RL-14H	198	RM-159	209	RM-30	215	RN-08	166
RH-78	189	RL-15	198	RM-16	209	RM-31	215	RN-10	166
RH-80	189	RL-15H	198	RM-161HV	209	RM-33	215	RN-11	166
RH-82	189	RL-16	198	RM-165H	209	RM-34HV	215	RN-12	166
RH-83	189	RL-17H	198	RM-168	209	RM-36	215	RN-13	166
RH-85	190	RL-20H	198	RM-169HV	210	RM-37	216	RN-13PL	166
RH-91	190	RL-21H	198	RM-170	210	RM-38	216	RN-14	167
RH-92	190	RL-22H	198	RM-175	210	RM-39HV	216	RN-15	167
RH-93	190	RL-23H	198	RM-176	210	RM-40	216	RN-15PL	167
RH-94	190	RM-01HV	204	RM-178C	210	RM-41	216	RN-16	167
RH-95	190	RM-02HV	204	RM-178HD	210	RM-42	216	RN-16PL	167
RH-97	190	RM-03HV	204	RM-179	210	RM-43	216	RN-17	167
RI-01HA	199	RM-04HV	204	RM-18	210	RM-44	217	RN-18	168
RI-02HA	199	RM-05HV	204	RM-180HV	210	RM-45	217	RN-19	168
RI-04H	199	RM-06	204	RM-181	210	RM-46	217	RN-20	168
RI-05H	199	RM-07HV	205	RM-182	211	RM-47	217	RN-22	168
RI-06H	199	RM-08HV	205	RM-183H	211	RM-48	217	RN-24	168
RI-07H	175	RM-09HV	205	RM-184	211	RM-50HV	217	RN-26	168
RI-08H	175	RM-100	205	RM-185	211	RM-53HV	217	RN-29	168
RI-09H	175	RM-105	205	RM-187H	211	RM-54HV	218	RN-30	168
RI-11H	199	RM-10HV	205	RM-189H	211	RM-57	218	RN-31	169
RI-12H	200	RM-11	205	RM-19	211	RM-58	218	RN-32	169
RI-13H	200	RM-110HV	206	RM-190HV	211	RM-59	218	RN-33	169
RI-14H	200	RM-112HV	206	RM-191H	193	RM-59HV	218	RN-33M	169
RI-15H	200	RM-115	206	RM-192	211	RM-60	218	RN-34	169
RI-16H	200	RM-116	206	RM-193HD	211	RM-62	219	RN-36	169
RI-17H	200	RM-117	203	RM-194	211	RM-63	219	RN-37	169
RI-18H	200	RM-118	203	RM-197	193	RM-65	219	RN-38	169
RI-19H	200	RM-119H	206	RM-198	203	RM-66	219	RN-39	170
RI-21H	200	RM-12	206	RM-199	211	RM-67	219	RN-40	170
RI-22H	200	RM-120	206	RM-200	212	RM-68	219	RN-41	170
RI-23H	200	RM-123	203	RM-201	212	RM-69	220	RN-41A	170
RI-23HD	200	RM-124	206	RM-202	212	RM-71	220	RN-44	170
RI-24H	201	RM-125HV	207	RM-203	212	RM-73	220	RN-45	170
RI-25	201	RM-126	207	RM-205	212	RM-74	220	RN-45H	170
RI-26H	201	RM-127	207	RM-207	212	RM-75	220	RN-46	170
RI-31H	201	RM-128	207	RM-208	212	RM-76	220	RN-46M	170
RI-32H	201	RM-129	207	RM-209	212	RM-78	221	RN-47	171
RI-32M	201	RM-129A	207	RM-20HV	212	RM-80	221	RN-48	171
RI-34	201	RM-130	207	RM-210HV	212	RM-81	221	RN-48M	171
RI-35	201	RM-131HV	207	RM-213	212	RM-82	221	RN-49	171
RK-01	194	RM-132	203	RM-216HD	213	RM-83	221	RN-50L	171
RK-02	194	RM-133	203	RM-22	213	RM-84	221	RN-51	171
RK-03	202	RM-134	207	RM-220HV	213	RM-85	221	RN-53	171
RK-04	193	RM-135	207	RM-221	213	RM-86	222	RN-54	171
RK-06	194	RM-136	208	RM-222HV	213	RM-87	222	RN-55	172
RL-01H	196	RM-139	208	RM-224	213	RM-89	222	RN-56	172
RL-02H	196	RM-14	208	RM-226HV	213	RM-90	222	RN-56M	172
RL-03H	196	RM-143	208	RM-23	213	RM-94	222	RN-57	172
RL-04H	196	RM-144	203	RM-231HV	214	RM-96	222	RN-59	172

PRODUCT INDEX

Part No.	Page	Part No.	Page	Part No.	Page	Part No.	Page	Part No.	Page
RN-60	172	RP-48	233	TB-B001	4	VR-B211	15	VR-B391	23
RN-63	172	RP-51	233	TB-M001	87	VR-B212	15	VR-B392	23
RN-64	172	RP-52	223	TB-M146	87	VR-B215	15	VR-B393	23
RN-66	172	RP-56	193	TB-ND097	40	VR-B217H	15	VR-B394	23
RN-67	172	RP-57	223	TB-ND098	40	VR-B218	15	VR-B396	24
RN-69	173	RP-59	223	TB-ND099	40	VR-B219	15	VR-B414	24
RN-70	173	RP-62	223	TB-ND160	40	VR-B220	15	VR-B4197	24
RN-71	173	RP-65HD	223	TB-ND163	40	VR-B221	15	VR-B510	24
RN-72	173	RP-66	223	TB-ND165	40	VR-B222	16	VR-B5204	24
RN-74	173	RP-68	223	TB-ND167	40	VR-B225	16	VR-B543B	24
RN-76	173	RP-69HD	223	VR-B020	4	VR-B226	16	VR-B558B	24
RN-77	173	RP-72	223	VR-B021	4	VR-B229	16	VR-B6151	24
RN-78	173	RP-80	224	VR-B026	4	VR-B235	16	VR-B6164	25
RN-81	173	RT-01H	226	VR-B029	4	VR-B238	16	VR-B657	25
RN-82	173	RT-02H	226	VR-B033	4	VR-B240H	16	VR-B703	25
RN-83	173	RT-03H	226	VR-B056	5	VR-B242	16	VR-B704	25
RN-84	173	RT-04H	226	VR-B057	5	VR-B243	16	VR-B807	25
RN-85	174	RT-05H	226	VR-B066	5	VR-B244	17	VR-B822	25
RN-86	174	RT-06H	226	VR-B0701	5	VR-B247	17	VR-B823	25
RN-87	174	RT-07H	227	VR-B0818	5	VR-B250	17	VR-B827	25
RN-88	174	RT-08H	227	VR-B088	5	VR-B251	17	VR-B835	26
RP-01	229	RT-09H	227	VR-B092	6	VR-B252	17	VR-B839	26
RP-02	229	RT-10H	227	VR-B100	6	VR-B253	17	VR-B840	26
RP-03	229	RT-12H	227	VR-B102	6	VR-B254	17	VR-B842	26
RP-04	229	RT-19H	233	VR-B103	6	VR-B255	18	VR-B843	26
RP-04H	229	RT-20H	233	VR-B104	6	VR-B256	18	VR-B854	26
RP-04HR	229	RT-21H	227	VR-B112	6	VR-B257	18	VR-B855	26
RP-04R	230	RT-23HD	228	VR-B118B	6	VR-B259	18	VR-B861	26
RP-05H	230	RT-24HD	228	VR-B122B	6	VR-B260	18	VR-B867	27
RP-06H	230	RU-01	225	VR-B129	7	VR-B260B	18	VR-B880	27
RP-06HR	230	RU-01H	225	VR-B131	7	VR-B261	18	VR-B883	27
RP-07	230	RV-H001	190	VR-B132	7	VR-B262	19	VR-B885	27
RP-08	230	RV-H002	190	VR-B135	7	VR-B263	19	VR-B903	27
RP-09	230	RV-H003B	190	VR-B137	7	VR-B264	19	VR-C524	28
RP-09A	231	RV-H004	190	VR-B150	7	VR-B265	19	VR-C545	28
RP-09R	231	RV-H005A	190	VR-B160	8	VR-B266	19	VR-C545H	28
RP-10	231	RV-H005BA	191	VR-B190	8	VR-B267	19	VR-D001B	30
RP-11	231	RV-H008	191	VR-B191	9	VR-B268	20	VR-D100	30
RP-13	231	RV-H009	191	VR-B192	9	VR-B269	20	VR-D1033	30
RP-14	231	RV-H013	191	VR-B193M	10	VR-B270	20	VR-D186	30
RP-15	231	RV-H017B	191	VR-B194	10	VR-B271	20	VR-D231	30
RP-16	231	RV-H022	191	VR-B195M	11	VR-B278	20	VR-D232	30
RP-17	232	RV-H023	191	VR-B196M	11	VR-B280	20	VR-D233	30
RP-19	232	RV-H024B	191	VR-B196MH	11	VR-B285	21	VR-D234	30
RP-20	232	RV-H025	191	VR-B197	12	VR-B295	21	VR-D235	30
RP-21	232	RV-H030	191	VR-B198	12	VR-B296	21	VR-D235SE	30
RP-22	232	RV-H034	191	VR-B199-3	12	VR-B300	21	VR-D238	31
RP-23	232	RV-H036	191	VR-B199-3A	13	VR-B3010	21	VR-D271	29
RP-24	232	RV-H040	192	VR-B199-4	13	VR-B3102	21	VR-D276	29
RP-27	232	RV-H046	192	VR-B200H	13	VR-B314	21	VR-D282	31
RP-35	232	RV-H047	192	VR-B201H	13	VR-B322	22	VR-D295	31
RP-36	232	RV-H049B	192	VR-B202	13	VR-B330	22	VR-D298	31
RP-37	232	RV-H050	192	VR-B202L	14	VR-B340	22	VR-D299	31
RP-38	233	RV-H052B	192	VR-B203	14	VR-B360	22	VR-D406B	31
RP-39H	233	RV-H053B	192	VR-B204	14	VR-B363	22	VR-D412	31
RP-40H	233	RV-H055N	192	VR-B205	14	VR-B369	22	VR-D424	31
RP-41	233	RV-H057B	192	VR-B206	14	VR-B371	22	VR-D432	31
RP-42	223	RV-H077B	192	VR-B207	14	VR-B372	22	VR-D440	31
RP-43	233	RV-H078	192	VR-B208H	14	VR-B378	23	VR-D445	32
RP-44	223	RV-H083B	192	VR-B209	14	VR-B379	23	VR-D481	32
RP-44A	223	RV-K002	193	VR-B210	15	VR-B385	23	VR-D502	32

PRODUCT INDEX

Part No.	Page	Part No.	Page	Part No.	Page	Part No.	Page	Part No.	Page
VR-D579H	32	VR-DU514	121	VR-H2000-14S	134	VR-H2000-56	71	VR-H2005-152	43
VR-D580	32	VR-DU515	121	VR-H2000-15	64	VR-H2000-57	71	VR-H2005-154	43
VR-D583	32	VR-F110A	82	VR-H2000-15S	134	VR-H2000-57S	135	VR-H2005-156	43
VR-D602H	32	VR-F110B	82	VR-H2000-16	65	VR-H2000-5H	71	VR-H2005-159	43
VR-D635	32	VR-F114A	82	VR-H2000-17	65	VR-H2000-5S	135	VR-H2005-15H	44
VR-D668B	32	VR-F114B	82	VR-H2000-18	65	VR-H2000-62	71	VR-H2005-15S	132
VR-D668C	33	VR-F118	82	VR-H2000-18S	134	VR-H2000-63	71	VR-H2005-162B	44
VR-D669C	33	VR-F119	82	VR-H2000-19	65	VR-H2000-64	71	VR-H2005-163	44
VR-D670C	33	VR-F119B	83	VR-H2000-1H	65	VR-H2000-65	72	VR-H2005-164A	44
VR-D671C	33	VR-F121	83	VR-H2000-1L	65	VR-H2000-6H	72	VR-H2005-165	44
VR-D672C	33	VR-F121T	83	VR-H2000-2	66	VR-H2000-70B	72	VR-H2005-166	44
VR-D673C	33	VR-F150A	83	VR-H2000-20	66	VR-H2000-71	72	VR-H2005-16A	45
VR-D674	33	VR-F151A	83	VR-H2000-21	66	VR-H2000-72	72	VR-H2005-171	45
VR-D674H	34	VR-F153A	83	VR-H2000-23	66	VR-H2000-73	72	VR-H2005-172	45
VR-D675H	34	VR-F153MB	83	VR-H2000-23S	134	VR-H2000-74	72	VR-H2005-173	45
VR-D676	34	VR-F154	83	VR-H2000-24	66	VR-H2000-75B	72	VR-H2005-176	45
VR-D677	34	VR-F154B	83	VR-H2000-26	66	VR-H2000-76B	72	VR-H2005-177	45
VR-D678H	34	VR-F155	83	VR-H2000-27	66	VR-H2000-76BA	72	VR-H2005-178	45
VR-D679SE	34	VR-F156	84	VR-H2000-28	66	VR-H2000-7H	72	VR-H2005-179	46
VR-D680	34	VR-F157	84	VR-H2000-28S	134	VR-H2000-8	72	VR-H2005-17A	46
VR-D681H	34	VR-F158	84	VR-H2000-29	66	VR-H2000-80B	73	VR-H2005-182	46
VR-D682	35	VR-F159	84	VR-H2000-29A-2	67	VR-H2000-80BA	73	VR-H2005-183	46
VR-D683H	35	VR-F160	84	VR-H2000-29B	67	VR-H2000-84	73	VR-H2005-184	46
VR-D686	35	VR-F161	45	VR-H2000-29BA-2	67	VR-H2000-85	73	VR-H2005-185	46
VR-D687	35	VR-F163	45	VR-H2000-29BC	67	VR-H2000-86B	73	VR-H2005-186	46
VR-D689	35	VR-F164	45	VR-H2000-29C	67	VR-H2000-87	73	VR-H2005-187	46
VR-D690	35	VR-F169	45	VR-H2000-2B	67	VR-H2000-88	73	VR-H2005-188	47
VR-D691	35	VR-F171	45	VR-H2000-3	67	VR-H2000-89	73	VR-H2005-18A	47
VR-D692	35	VR-F540A	59	VR-H2000-30	68	VR-H2000-9	73	VR-H2005-190	47
VR-D694H	35	VR-F540DH	59	VR-H2000-32	68	VR-H2000-91	73	VR-H2005-193	47
VR-D694HD	36	VR-F7078	59	VR-H2000-33	68	VR-H2000-92B	74	VR-H2005-194	47
VR-D694SE	36	VR-F756	59	VR-H2000-34	68	VR-H2000-94B	74	VR-H2005-195	47
VR-D696B	36	VR-F784H	59	VR-H2000-35	68	VR-H2000-9S	135	VR-H2005-196	47
VR-D701	36	VR-F784M	59	VR-H2000-36	68	VR-H2001-1	63	VR-H2005-197	47
VR-D702H	36	VR-F786BH	59	VR-H2000-37	68	VR-H2001-2	63	VR-H2005-198	48
VR-D702SE	36	VR-F786H	59	VR-H2000-38	68	VR-H2001-3	63	VR-H2005-199	48
VR-D703H	36	VR-F786HB	59	VR-H2000-38S	134	VR-H2002-1	111	VR-H2005-19A	48
VR-D705H	36	VR-F786HC	59	VR-H2000-39	69	VR-H2002-2	111	VR-H2005-2	48
VR-D706H	36	VR-F786M	60	VR-H2000-3A	69	VR-H2002-3	111	VR-H2005-200	48
VR-D707	37	VR-F786SE	60	VR-H2000-40	69	VR-H2003-1B	110	VR-H2005-203	48
VR-D709	37	VR-F811	60	VR-H2000-41	69	VR-H2003-2B	110	VR-H2005-204	48
VR-D711	37	VR-F811BH	60	VR-H2000-41S	134	VR-H2005-1	41	VR-H2005-206	48
VR-D712	37	VR-F814	60	VR-H2000-42	69	VR-H2005-10	41	VR-H2005-208	49
VR-D713	37	VR-F815	60	VR-H2000-43	69	VR-H2005-100	41	VR-H2005-210	49
VR-D714SE	37	VR-F817	60	VR-H2000-44	69	VR-H2005-101	41	VR-H2005-213	49
VR-D715	37	VR-F818	61	VR-H2000-44S	134	VR-H2005-102B	41	VR-H2005-214	49
VR-D716	37	VR-F821	61	VR-H2000-45	69	VR-H2005-104	41	VR-H2005-215	49
VR-D717	37	VR-F822	61	VR-H2000-46	70	VR-H2005-105	42	VR-H2005-218	49
VR-D719	38	VR-F900	61	VR-H2000-46S	134	VR-H2005-107	42	VR-H2005-219	49
VR-D720	38	VR-F901	61	VR-H2000-47	70	VR-H2005-10S	132	VR-H2005-221	49
VR-D737	38	VR-F910	61	VR-H2000-47C	70	VR-H2005-11	42	VR-H2005-222	49
VR-D740	38	VR-F911	61	VR-H2000-48	70	VR-H2005-12	42	VR-H2005-223	49
VR-D744	38	VR-F920	61	VR-H2000-48S	134	VR-H2005-140	42	VR-H2005-226	49
VR-D745	38	VR-F930	61	VR-H2000-4H	70	VR-H2005-142	42	VR-H2005-22S	132
VR-D747HD	38	VR-F931	62	VR-H2000-50	70	VR-H2005-144	42	VR-H2005-23A	50
VR-D755	38	VR-H2000-1	64	VR-H2000-51	70	VR-H2005-146	43	VR-H2005-23AS	132
VR-DU509	120	VR-H2000-11	64	VR-H2000-52	70	VR-H2005-148	43	VR-H2005-24	50
VR-DU510	120	VR-H2000-12	64	VR-H2000-52S	134	VR-H2005-149	43	VR-H2005-25	50
VR-DU511	120	VR-H2000-13	64	VR-H2000-53	71	VR-H2005-14H	43	VR-H2005-25S	132
VR-DU512	120	VR-H2000-13S	134	VR-H2000-55B	71	VR-H2005-150	43	VR-H2005-26A	50
VR-DU513	121	VR-H2000-14	64	VR-H2000-55BS	135	VR-H2005-151B	43	VR-H2005-26AS	132

PRODUCT INDEX

Part No.	Page	Part No.	Page	Part No.	Page	Part No.	Page	Part No.	Page
VR-H2005-28	50	VR-H2009-100	87	VR-H2009-164	94	VR-H2009-41	101	VR-H2009-8H	107
VR-H2005-29	50	VR-H2009-102	87	VR-H2009-168	94	VR-H2009-43	101	VR-H2009-90	108
VR-H2005-2W	51	VR-H2009-103	87	VR-H2009-169	94	VR-H2009-43S	138	VR-H2009-92	108
VR-H2005-3	51	VR-H2009-105	88	VR-H2009-17	94	VR-H2009-44	101	VR-H2009-93	108
VR-H2005-30A	51	VR-H2009-105S	137	VR-H2009-170	94	VR-H2009-44S	138	VR-H2009-94	108
VR-H2005-31A	51	VR-H2009-105SE	88	VR-H2009-171	95	VR-H2009-45	101	VR-H2009-94S	139
VR-H2005-32A	51	VR-H2009-106	86	VR-H2009-172	95	VR-H2009-45S	138	VR-H2009-95	108
VR-H2005-33A	51	VR-H2009-107	88	VR-H2009-173	95	VR-H2009-46	102	VR-H2009-95S	139
VR-H2005-33AS	132	VR-H2009-108	88	VR-H2009-175	95	VR-H2009-47	102	VR-H2009-96B	108
VR-H2005-34	52	VR-H2009-108S	137	VR-H2009-176	95	VR-H2009-48	102	VR-H2009-97	108
VR-H2005-35	52	VR-H2009-109	88	VR-H2009-177	95	VR-H2009-49	102	VR-H2009-98	109
VR-H2005-36A	52	VR-H2009-10A	88	VR-H2009-18	96	VR-H2009-49S	138	VR-H2009-99	109
VR-H2005-37A	52	VR-H2009-10AS	137	VR-H2009-180	96	VR-H2009-4A	102	VR-H2009-99S	139
VR-H2005-39	52	VR-H2009-110	89	VR-H2009-182	96	VR-H2009-4H	102	VR-H2009-9H	109
VR-H2005-39SE	52	VR-H2009-111	89	VR-H2009-183B	96	VR-H2009-4S	138	VR-IK01	76
VR-H2005-3S	132	VR-H2009-112	89	VR-H2009-185	96	VR-H2009-50	103	VR-IK019	76
VR-H2005-40	53	VR-H2009-112S	137	VR-H2009-187	75	VR-H2009-50S	138	VR-IK02	76
VR-H2005-40A	53	VR-H2009-113	89	VR-H2009-188	96	VR-H2009-51	103	VR-IK029	76
VR-H2005-40T	53	VR-H2009-114	89	VR-H2009-189	96	VR-H2009-53	103	VR-IK149	76
VR-H2005-45A	53	VR-H2009-115	89	VR-H2009-19	97	VR-H2009-54	103	VR-IK15	76
VR-H2005-46A	53	VR-H2009-115S	137	VR-H2009-191B	97	VR-H2009-56	103	VR-JD357	77
VR-H2005-48A	53	VR-H2009-116	78	VR-H2009-192B	75	VR-H2009-57	103	VR-K01	78
VR-H2005-4A	53	VR-H2009-117	89	VR-H2009-193B	97	VR-H2009-58	103	VR-K01B	78
VR-H2005-4AS	132	VR-H2009-118	90	VR-H2009-194	97	VR-H2009-58S	138	VR-K02	78
VR-H2005-50A	54	VR-H2009-119	90	VR-H2009-195	97	VR-H2009-59	103	VR-K03	29
VR-H2005-52A	54	VR-H2009-11H	90	VR-H2009-196	97	VR-H2009-5S	138	VR-K04	29
VR-H2005-58	54	VR-H2009-11S	137	VR-H2009-197B	97	VR-H2009-62	104	VR-K05	78
VR-H2005-59	54	VR-H2009-12	90	VR-H2009-198	97	VR-H2009-63	104	VR-K06B	29
VR-H2005-5H	54	VR-H2009-120	90	VR-H2009-199	97	VR-H2009-64	104	VR-K09	78
VR-H2005-5S	132	VR-H2009-121	90	VR-H2009-20	98	VR-H2009-64A	104	VR-LC100	80
VR-H2005-60	54	VR-H2009-122	90	VR-H2009-201	98	VR-H2009-65	104	VR-LC106	80
VR-H2005-62A	55	VR-H2009-123	91	VR-H2009-203	98	VR-H2009-66TF	104	VR-LC107	80
VR-H2005-62AS	132	VR-H2009-125B	91	VR-H2009-204	98	VR-H2009-67	104	VR-LC108	80
VR-H2005-63A	55	VR-H2009-126	91	VR-H2009-205B	98	VR-H2009-69	104	VR-LC110	80
VR-H2005-64A	55	VR-H2009-128	91	VR-H2009-207B	98	VR-H2009-69B	105	VR-LC111	80
VR-H2005-65	55	VR-H2009-129	91	VR-H2009-208	98	VR-H2009-6A	105	VR-LC111B	80
VR-H2005-66	55	VR-H2009-130	91	VR-H2009-209	98	VR-H2009-6H	105	VR-LC112	80
VR-H2005-6H	55	VR-H2009-132B	91	VR-H2009-20S	137	VR-H2009-6HL	105	VR-LC113L	81
VR-H2005-6S	132	VR-H2009-132BA	91	VR-H2009-21	98	VR-H2009-70A	105	VR-LC115	81
VR-H2005-77	56	VR-H2009-135B	92	VR-H2009-210	98	VR-H2009-70AS	138	VR-LC200	81
VR-H2005-7A	56	VR-H2009-139	92	VR-H2009-212	98	VR-H2009-71	105	VR-LC201	81
VR-H2005-8	56	VR-H2009-140	92	VR-H2009-218	99	VR-H2009-73	106	VR-LD150A	79
VR-H2005-81	56	VR-H2009-141	92	VR-H2009-22	99	VR-H2009-73S	138	VR-LD160	79
VR-H2005-82	56	VR-H2009-144	92	VR-H2009-220	99	VR-H2009-75	106	VR-MD01	86
VR-H2005-83	56	VR-H2009-145	92	VR-H2009-23	99	VR-H2009-77B	106	VR-MD03	86
VR-H2005-85	56	VR-H2009-147	92	VR-H2009-24	99	VR-H2009-78	106	VR-MD04	86
VR-H2005-87	57	VR-H2009-148	93	VR-H2009-25	99	VR-H2009-79	106	VR-MD06	86
VR-H2005-88	57	VR-H2009-14N	93	VR-H2009-26	99	VR-H2009-7H	106	VR-MD06L	86
VR-H2005-89	57	VR-H2009-14NS	137	VR-H2009-27	100	VR-H2009-7S	138	VR-MD07	86
VR-H2005-90	57	VR-H2009-15	93	VR-H2009-28	100	VR-H2009-80	107	VR-MD07S	136
VR-H2005-91	57	VR-H2009-151B	93	VR-H2009-3	100	VR-H2009-80B	107	VR-MD08	86
VR-H2005-92	57	VR-H2009-152	93	VR-H2009-30	100	VR-H2009-82	107	VR-MD12	86
VR-H2005-93	58	VR-H2009-153	93	VR-H2009-32	100	VR-H2009-82S	138	VR-MD13B	75
VR-H2005-94	58	VR-H2009-154B	93	VR-H2009-33	100	VR-H2009-83	107	VR-MD14B	75
VR-H2005-95	58	VR-H2009-157	93	VR-H2009-34	100	VR-H2009-85	107	VR-MP134	85
VR-H2005-96	58	VR-H2009-159	93	VR-H2009-35	100	VR-H2009-86	86	VR-MP419	85
VR-H2005-99	58	VR-H2009-159S	137	VR-H2009-37	101	VR-H2009-86S	136	VR-PR002H	124
VR-H2005-9A	58	VR-H2009-15S	137	VR-H2009-38	101	VR-H2009-88	107	VR-PR003H	124
VR-H2005-9AS	133	VR-H2009-16	94	VR-H2009-38S	137	VR-H2009-88S	139	VR-PR1000H	124
VR-H2009	87	VR-H2009-160	94	VR-H2009-40	101	VR-H2009-89	86	VR-PR1060H	124
VR-H2009-1	87	VR-H2009-161	94	VR-H2009-40S	137	VR-H2009-89S	139	VR-PR123	124

PRODUCT INDEX

Part No.	Page	Part No.	Page	Part No.	Page	Part No.	Page	Part No.	Page
VR-PR124	124	VR-V2871	114	DD-1001	235	DD-1076	235	VR-RVC01W	239
VR-PR126	124	VR-V2975	114	DD-1002	235	DD-1077	237	PL-ALT9805	239
VR-PR127B	125	VR-V2988	114	DD-1003	235	DD-1078	237	PL-RLO482	239
VR-PR128	125	VR-V3231	114	DD-1004	235	DD-1079	237	PL-RVC468	239
VR-PR128B	125	VR-V3279	114	DD-1005	235	DD-1080	237	PL-RVC9151	239
VR-PR130	125	VR-V3406SE	114	DD-1006	235	DD-1083	237		
VR-PR132B	125	VR-V3419	114	DD-1007	235	DD-1084	237		
VR-PR135	125	VR-V3419SE	114	DD-1008	235	DD-1085	235		
VR-PR135B	125	VR-V3530	115	DD-1010	235	DD-1086	235		
VR-PR135BA	125	VR-V3536	115	DD-1011	235	DD-1087	237		
VR-PR1424H	126	VR-V3591	115	DD-1012	235	DD-1088	237		
VR-PR152A	126	VR-V3666	115	DD-1013	235	DD-1089	237		
VR-PR1620H	126	VR-V3689	115	DD-1014	235	DD-1090	237		
VR-PR1667	126	VR-V3722	115	DD-1015	235	DD-1091	237		
VR-PR1669	126	VR-V3779	115	DD-1016	235	DD-1092	237		
VR-PR1671	126	VR-V3780	115	DD-1017	235	DD-1093	236		
VR-PR1926	126	VR-V3788	115	DD-1020	236	DD-1094	236		
VR-PR1935	127	VR-V3793	115	DD-1021	236	DD-1095	235		
VR-PR2000H	127	VR-V3796	116	DD-1022	236	DD-1096	235		
VR-PR2206	127	VR-V3874	116	DD-1023	236	DD-1097	235		
VR-PR2222	127	VR-V3975	116	DD-1024	236	DD-1098	235		
VR-PR2288	127	VR-V4114	116	DD-1025	236	DD-1099	235		
VR-PR2292H	127	VR-V4291	116	DD-1026	235	DD-1100	235		
VR-PR2293	127	VR-V4803	116	DD-1027	235	DD-1101	235		
VR-PR2299H	127	VR-V5001	116	DD-1028	235	DD-1102	235		
VR-PR2339	128	VR-V5120	116	DD-1029	235	DD-1103	235		
VR-PR2700	128	VR-V5339	116	DD-1030	235	DD-1104	235		
VR-PR2765	128	VR-V5366	117	DD-1031	235	DD-1105	236		
VR-PR3389	128	VR-V5428	117	DD-1034	237	DD-1106	236		
VR-PR3430	128	VR-V5460	117	DD-1035	237	DD-1107	236		
VR-PR3529	128	VR-V5633	117	DD-1036	237	DD-1108	236		
VR-PR3534	128	VR-V5745	117	DD-1037	237	DD-1111	235		
VR-PR3617H	129	VR-V5904	117	DD-1038	236	DD-1112	235		
VR-PR3729A	129	VR-V6131	117	DD-1039	236	DD-1113	235		
VR-PR3960	129	VR-V7052	117	DD-1040	235	DD-1114	235		
VR-PR4920	129	VR-V7059	117	DD-1041	235	DD-1115	236		
VR-PR5011	129	VR-V7131	118	DD-1042	235	DD-1116	236		
VR-PR5023	129	VR-V7144	118	DD-1043	235	DD-1117	236		
VR-PR6366	130	VR-V7319	118	DD-1047	237	DD-1118	236		
VR-PR6603H	130	VR-V8052	118	DD-1048	237	DD-1119	236		
VR-PR7736	130	VR-V8054	118	DD-1053	236	DD-1120	236		
VR-V0030	112	VR-V8060	118	DD-1054	236	DD-1121	236		
VR-V005	112	VR-V8237	118	DD-1055	236	DD-1122	236		
VR-V014	112	VR-V8326	118	DD-1056	236	DD-1125	235		
VR-V015	112	VR-V8417	119	DD-1059	236	DD-1126	235		
VR-V016	112	VR-V8689	119	DD-1060	236	DT-02	234		
VR-V018	75	VR-V9446	119	DD-1061	235	DT-07	234		
VR-V019B	75	VR-V9938	119	DD-1062	235	DT-08	234		
VR-V0219	112	VR-VN001	131	DD-1063	237	DT-09	234		
VR-V024	112	VR-VN002	131	DD-1064	237	DT-13	234		
VR-V0441	112	VR-VN005	131	DD-1065	236	DT-14	234		
VR-V0447	112	VR-VW002	122	DD-1066	236	DT-15	234		
VR-V0572	113	VR-VW003	122	DD-1067	236	DT-17	234		
VR-V1610	113	VR-VW005N	122	DD-1068	236	DT-18	234		
VR-V1658	113	VR-VW005NH	122	DD-1069	236	VR-COM02	238		
VR-V2118	113	VR-VW006	122	DD-1070	236	VR-COM01	238		
VR-V2263	113	VR-VW007	122	DD-1071	235	VR-RVC01	238		
VR-V2499	113	VR-VW009	123	DD-1072	235	10810216	238		
VR-V2599	113	VR-VW010	123	DD-1073	235	10810263	238		
VR-V2604	113	VR-Y002	39	DD-1074	235	10810269	238		
VR-V2775	113	VR-Y015	39	DD-1075	235	10810214	239		

**CROSS REFERENCE
Voltage Regulator**

OEM No. → Mobiletron No.

OEM No.	Part No.	Page	OEM No.	Part No.	Page	OEM No.	Part No.	Page
ALFA ROMEO			12317551256	VR-B033	4	0190601011	VR-B191	9
530165	VR-B191	9	12317561924	VR-B033	4	0190601011	VR-B191	9
530165	VR-B190	8	12317561939	VR-B033	4	0-190-601-011	VR-B190	8
7001656	VR-B193M	10	12318515518	VR-V2988	114	0190601012	VR-B191	9
AMC			12321271644	VR-B196M	11	0-190-601-012	VR-B190	8
8125176	VR-D668C	33	12321711399	VR-B196M	11	0190601013	VR-B191	9
AUDI			1350052	VR-B191	9	0-190-601-013	VR-B190	8
06B903803	VR-PR2292H	127	1350052	VR-B190	8	0-190-601-014	VR-DU509	120
06B903803A	VR-PR2292H	127	1355456	VR-B190	8	0190601017	VR-B191	9
06B903803B	VR-PR2292H	127	1355456	VR-B191	9	0-190-601-017	VR-B190	8
078903803C	VR-PR2292H	127	1711391	VR-B196M	11	0190601018	VR-B191	9
AUDI/VW			8708000	VR-B191	9	0-190-601-018	VR-B190	8
021903803A	VR-B190	8	8708000	VR-B190	8	0-192-033-001	VR-B199-3	12
021903803A	VR-B191	9	BOMAG			0-192-033-002	VR-B199-3	12
021903803B	VR-B200H	13	5710950	VR-B193M	10	0-192-033-003	VR-B199-4	13
026903015E	VR-VW005N	122	5710956	VR-B202	13	0-192-033-004	VR-B199-3	12
028903803A	VR-B192	9	5710957	VR-B193M	10	0-192-033-005	VR-B199-4	13
028903803B	VR-B200H	13	BOSCH			0-192-052-001	VR-B192	9
028903803C	VR-B200H	13	0 272 220 867	VR-B867	27	0-192-052-002	VR-B192	9
028903803D	VR-B222	16	0-031-542-906	VR-B264	19	0192052003	VR-B193M	10
028903803F	VR-VW010	123	0-031-543-706	VR-B385	23	0-192-052-003	VR-B192	9
036903803A	VR-VW005N	122	0-031-545-806	VR-B385	23	0-192-052-004	VR-B192	9
037903803	VR-VW005N	122	01229AA0X0	VR-B257	18	0-192-052-005	VR-B192	9
038903803F	VR-B271	20	0-124-525-216	VR-B271	20	0-192-052-006	VR-B192	9
043903803B	VR-B191	9	0190062001	VR-B191	9	0192052007	VR-B220	15
043903803B	VR-B190	8	0190062002	VR-B191	9	0-192-052-008	VR-B192	9
049903803B	VR-B192	9	0190062004	VR-B191	9	0192052010	VR-B220	15
049903803E	VR-B192	9	0190062005	VR-B191	9	0-192-052-011	VR-B192	9
049903803F	VR-B192	9	0190062007	VR-B191	9	0-192-052-012	VR-B192	9
049903803H	VR-VW005	122	0190600001	VR-B191	9	0-192-052-013	VR-B192	9
059903803A	VR-B191	9	0-190-600-001	VR-B190	8	0-192-052-014	VR-B192	9
059903803A	VR-B190	8	0190600002	VR-B191	9	0-192-052-015	VR-B194	10
059903803B	VR-B192	9	0-190-600-002	VR-B190	8	0-192-052-016	VR-B194	10
059903803C	VR-B192	9	0190600003	VR-B191	9	0-192-052-017	VR-B192	9
068903803B	VR-B195M	11	0-190-600-003	VR-B190	8	0192052018	VR-B193M	10
068903803D	VR-B195M	11	0190600004	VR-B191	9	0-192-052-018	VR-B192	9
070903803A	VR-B192	9	0-190-600-004	VR-B190	8	0-192-052-019	VR-B192	9
078903803A	VR-VW010	123	0190600005	VR-B191	9	0-192-052-020	VR-B194	10
078903803B	VR-VW010	123	0-190-600-005	VR-B190	8	0-192-052-021	VR-B194	10
171903803	VR-VW002	122	0190600006	VR-B191	9	0-192-052-022	VR-B192	9
21903803	VR-B191	9	0-190-600-006	VR-B190	8	0-192-052-023	VR-B204	14
21903803	VR-B190	8	0190600007	VR-B191	9	0-192-052-024	VR-B194	10
28903803	VR-B190	8	0-190-600-007	VR-B190	8	0-192-052-025	VR-B194	10
28903803	VR-B191	9	0190600008	VR-B191	9	0-192-052-026	VR-B192	9
34903803	VR-B196MH	11	0-190-600-008	VR-B190	8	0-192-052-027	VR-B194	10
36903803	VR-VW003	122	0190600009	VR-B191	9	0-192-052-028	VR-B192	9
411903803A	VR-B190	8	0-190-600-009	VR-B190	8	0-192-052-029	VR-B194	10
411903803A	VR-B191	9	0190600010	VR-B191	9	0-192-052-030	VR-B205	14
52903803	VR-B192	9	0-190-600-010	VR-B190	8	0-192-052-031	VR-B192	9
53903803	VR-B192	9	0190600011	VR-B191	9	0-192-052-032	VR-B194	10
55903803	VR-VW002	122	0-190-600-011	VR-B190	8	0192052033	VR-B202L	14
55903804	VR-VW002	122	0190600012	VR-B191	9	0-192-052-033	VR-B202	13
59903803	VR-B191	9	0-190-600-012	VR-B190	8	0192052035	VR-B202L	14
59903803	VR-B190	8	0190600013	VR-B191	9	0-192-052-035	VR-B194	10
63903803	VR-B192	9	0-190-600-013	VR-B190	8	0-192-052-035	VR-B202	13
68903803	VR-B195M	11	0190600014	VR-B191	9	0-192-053-001	VR-B197	12
78903803	VR-B200H	13	0-190-600-014	VR-B190	8	0-192-053-002	VR-B197	12
J270004010	VR-B195M	11	0190600015	VR-B191	9	0-192-053-003	VR-B206	14
BL/JAGUAR			0-190-600-015	VR-B190	8	0-192-053-004	VR-B197	12
37H6911	VR-LC100	80	0190600016	VR-B191	9	0-192-053-005	VR-B198	12
520076	VR-LC100	80	0-190-600-016	VR-B190	8	0-192-053-006	VR-B198	12
607687	VR-LC100	80	0190600017	VR-B191	9	0-192-053-007	VR-B197	12
AAU4842	VR-LC100	80	0-190-600-017	VR-B190	8	0-192-053-008	VR-B197	12
ABU9969	VR-LC100	80	0190600018	VR-B191	9	0-192-053-009	VR-B206	14
AEU1526	VR-LC200	81	0-190-600-018	VR-B190	8	0192053011	VR-B203	14
AEU1669	VR-LC200	81	0190600020	VR-B191	9	0-192-053-011	VR-B198	12
AEU1915	VR-LC200	81	0-190-600-020	VR-B190	8	0-192-053-012	VR-B206	14
AEU2750	VR-LC200	81	0190600021	VR-B191	9	0-192-053-013	VR-B198	12
AEU4007A	VR-LC200	81	0-190-600-021	VR-B190	8	0-192-053-014	VR-B206	14
BAU4443	VR-LC100	80	0190601001	VR-B191	9	0-192-053-016	VR-B198	12
BBU2117	VR-LC200	81	0-190-601-001	VR-B190	8	0-192-053-017	VR-B198	12
BBU3021	VR-LC200	81	0190601002	VR-B191	9	0-192-053-018	VR-B198	12
BBU3773	VR-LC200	81	0-190-601-002	VR-B190	8	0-192-053-019	VR-B198	12
JS485	VR-LC100	80	0190601003	VR-B191	9	0-192-053-022	VR-B198	12
BMW			0-190-601-003	VR-B190	8	0-192-053-023	VR-B198	12
01244409	VR-B190	8	0190601006	VR-B191	9	0-192-053-025	VR-B206	14
01244409	VR-B191	9	0-190-601-006	VR-B190	8	0-192-053-027	VR-B197	12
12311268073	VR-B193M	10	0190601007	VR-B191	9	0192053032	VR-B202L	14
12311268387	VR-B193M	10	0-190-601-007	VR-B190	8	0-192-053-032	VR-B202	13
12311279548	VR-B196M	11	0190601008	VR-B191	9	0192062001	VR-B191	9
12311286073	VR-B193M	10	0-190-601-008	VR-B190	8	0-192-062-001	VR-B190	8
12311710732	VR-B193M	10	0190601009	VR-B191	9	0192062002	VR-B191	9
12311726002	VR-B195M	11	0-190-601-009	VR-B190	8	0-192-062-002	VR-B190	8
12317515319	VR-B280	20	0190601010	VR-B191	9	0192062004	VR-B191	9
12317551254	VR-B033	4	0-190-601-010	VR-B190	8	0-192-062-004	VR-B190	8

**CROSS REFERENCE
Voltage Regulator**

OEM No. → Mobiletron No.

OEM No.	Part No.	Page	OEM No.	Part No.	Page	OEM No.	Part No.	Page
0192062005	VR-B191	9	1-197-311-034	VR-B202	13	1197311548	VR-B200H	13
0-192-062-005	VR-B190	8	1197311035	VR-B196M	11	1-197-311-551	VR-B240H	16
0192062007	VR-B191	9	1-197-311-035	VR-B196MH	11	1-197-311-552	VR-B240H	16
0-192-062-007	VR-B190	8	1-197-311-038	VR-B196MH	11	1-197-311-553	VR-B240H	16
0-272-220-701	VR-B0701	5	1197311039	VR-B196M	11	1197311556	VR-B201H	13
0-272-220-703	VR-B703	25	1-197-311-040	VR-B196MH	11	1197311557	VR-B238	16
0-272-220-704	VR-B704	25	1-197-311-041	VR-B196MH	11	1-197-311-558	VR-B558B	24
0272220714	VR-B0701	5	1197311043	VR-B202L	14	1197311800	VR-B196M	11
0-272-220-720	VR-B0701	5	1-197-311-043	VR-B202	13	1-197-311-800	VR-B196MH	11
0-272-220-731	VR-B0701	5	1197311045	VR-B260	18	123500520	VR-B543B	24
0272220744	VR-B0701	5	1197311045	VR-B202L	14	136325	VR-B191	9
0-272-220-804	VR-B854	26	1-197-311-045	VR-B202	13	137127	VR-B196M	11
0-272-220-807	VR-B807	25	1197311046	VR-B260	18	192053021	VR-B219	15
0-272-220-809	VR-B839	26	1197311047	VR-B220	15	197311030	VR-B202L	14
0-272-220-818	VR-B0818	5	1-197-311-050	VR-B196MH	11	2197311008	VR-B196M	11
0-272-220-822	VR-B822	25	1197311090	VR-B193M	10	2197311022	VR-B196M	11
0-272-220-823	VR-B823	25	1197311175	VR-B200H	13	2197311026	VR-B202L	14
0-272-220-824	VR-B854	26	1197311211	VR-B201H	13	2-197-311-026	VR-B202	13
0-272-220-827	VR-B827	25	1197311212	VR-B200H	13	2197311028	VR-B202L	14
0-272-220-835	VR-B835	26	1197311213	VR-B201H	13	2-197-311-028	VR-B202	13
0-272-220-839	VR-B839	26	1197311214	VR-B200H	13	2197311029	VR-B202L	14
0-272-220-840	VR-B840	26	1197311217	VR-B201H	13	2-197-311-029	VR-B202	13
0-272-220-842	VR-B842	26	1197311219	VR-B201H	13	2197311032	VR-B260	18
0-272-220-843	VR-B843	26	1197311220	VR-B200H	13	2197311090	VR-B193M	10
0-272-220-854	VR-B854	26	1197311221	VR-B200H	13	2197311301	VR-B203	14
0-272-220-855	VR-B855	26	1197311222	VR-B200H	13	2-197-311-310	VR-B260B	18
0-272-220-903	VR-B903	27	1197311223	VR-B200H	13	6-004-MR0-000	TB-B001	4
0-272-223-010	VR-B3010	21	1197311224	VR-B200H	13	6033RD0002	VR-B203	14
0-272-223-102	VR-B3102	21	1197311225	VR-B200H	13	6033RD2006	VR-B209	14
0-272-223-105	VR-B3102	21	1197311227	VR-B200H	13	9-121-080-303	VR-B211	15
0-986-192-000	VR-D668C	33	1197311228	VR-B200H	13	9152053021	VR-B219	15
0-986-192-005	VR-F114A	82	1197311229	VR-B200H	13	9-190-041-002	VR-B250	17
0-986-192-006	VR-LC100	80	1-197-311-231	VR-B225	16	9-190-067-001	VR-B194	10
0-986-192-015	VR-D673C	33	1197311232	VR-B200H	13	9-190-067-003	VR-B194	10
0-986-192-016	VR-H2009	87	1197311233	VR-B200H	13	9-190-067-005	VR-B194	10
0-986-192-017	VR-H2005-1	41	1-197-311-234	VR-B208H	14	9-190-067-011	VR-B194	10
0-986-192-019	VR-H2005-11	42	1197311235	VR-B200H	13	9-190-067-016	VR-B391	23
0-986-192-021	VR-H2005-4A	53	1197311236	VR-B200H	13	9-190-067-017	VR-B391	23
0-986-192-022	VR-H2005-7A	56	1197311237	VR-B200H	13	9190067018	VR-B392	23
0-986-192-023	VR-H2005-3	51	1197311238	VR-B200H	13	9-190-067-019	VR-B391	23
0-986-192-024	VR-H2005-37A	52	1-197-311-239	VR-B208H	14	9-190-067-020	VR-B391	23
0-986-192-026	VR-H2000-1H	65	1-197-311-240	VR-B240H	16	9-190-085-000	VR-B100	6
0-986-192-026	VR-H2000-1	64	1197311241	VR-B200H	13	9190085001	VR-B191	9
0-986-192-026	VR-H2000-1L	65	1197311242	VR-B201H	13	9190085001	VR-B191	9
0-986-192-026	VR-H2000-32	68	1197311277	VR-B200H	13	9-190-085-001	VR-B190	8
0-986-192-028	VR-H2000-37	68	1197311300	VR-B203	14	9-190-087-003	VR-B211	15
0-986-192-030	VR-H2000-3	67	1197311301	VR-B203	14	9-190-087-005	VR-B199-3A	13
0-986-192-036	VR-H2000-1H	65	1197311304	VR-B203	14	9190087011	VR-B191	9
0-986-192-036	VR-H2000-1	64	1197311304	VR-B209	14	9-190-087-011	VR-B190	8
0-986-192-036	VR-H2000-1L	65	1197311305	VR-B203	14	9190087020	VR-B202L	14
0-986-192-036	VR-H2000-32	68	1197311306	VR-B203	14	9-190-087-020	VR-B202	13
1-119-311-231	VR-B225	16	1197311307	VR-B203	14	9190087023	VR-B202L	14
1127311527	VR-B200H	13	1-197-311-309	VR-B210	15	9-190-087-023	VR-B202	13
1197311000	VR-B193M	10	1-197-311-310	VR-B260B	18	9-190-087-026	VR-B103	6
1197311001	VR-B193M	10	1-197-311-313	VR-B260B	18	9-190-087-028	VR-B104	6
1197311002	VR-B193M	10	1-197-311-314	VR-B260B	18	9-190-087-032	VR-B103	6
1197311003	VR-B196M	11	1-197-311-315	VR-B206	14	9-190-087-040	VR-B217H	15
1-197-311-004	VR-B195M	11	1197311319	VR-B219	15	9-190-110-031	VR-DU510	120
1-197-311-005	VR-B195M	11	1197311320	VR-B219	15	9-190-110-032	VR-F110A	82
1-197-311-006	VR-B195M	11	1197311324	VR-B209	14	9-190-110-034	VR-DU510	120
1197311007	VR-B196M	11	1197311500	VR-B222	16	9-190-110-041	VR-DU510	120
1197311008	VR-B196M	11	1197311506	VR-B238	16	9-190-110-539	VR-DU509	120
1-197-311-008	VR-B196MH	11	1-197-311-510	VR-B510	24	9-190-333-704	VR-F110B	82
1197311009	VR-B196M	11	1-197-311-511	VR-B235	16	9-190-333-707	VR-F110A	82
1-197-311-010	VR-B195M	11	1-197-311-512	VR-B240H	16	9-190-455-001	VR-B215	15
1-197-311-011	VR-B195M	11	1-197-311-514	VR-B208H	14	9-190-455-009	VR-B215	15
1-197-311-012	VR-B195M	11	1197311516	VR-B238	16	9-190-457-002	VR-B218	15
1-197-311-013	VR-B195M	11	1-197-311-518	VR-B229	16	9190457003	VR-B219	15
1197311018	VR-B196M	11	1197311519	VR-B200H	13	9-190-457-006	VR-B212	15
1-197-311-021	VR-B195M	11	1-197-311-520	VR-B229	16	9-190-457-007	VR-B102	6
1197311022	VR-B196M	11	1197311521	VR-B200H	13	9190457048	VR-B219	15
1-197-311-022	VR-B196MH	11	1197311522	VR-B200H	13	9-191-067-043	VR-B393	23
1197311023	VR-B196M	11	1197311523	VR-B222	16	9-191-337-302	VR-B207	14
1-197-311-024	VR-B195M	11	1197311527	VR-B200H	13	9-191-337-303	VR-B195M	11
1-197-311-026	VR-B196MH	11	1197311528	VR-B200H	13	9-191-337-306	VR-B207	14
1-197-311-027	VR-B196MH	11	1197311530	VR-B222	16	9-191-337-310	VR-B226	16
1-197-311-028	VR-B195M	11	1197311531	VR-B222	16	9191337311	VR-B220	15
1197311029	VR-B202L	14	1197311533	VR-B201H	13	F002G10376079	VR-B269	20
1-197-311-029	VR-B202	13	1197311536	VR-B238	16	F00M 144 151	VR-B4197	24
1-197-311-030	VR-B202	13	1197311540	VR-B200H	13	F-00M-141-381	VR-B242	16
1197311031	VR-B202L	14	1-197-311-541	VR-B261	18	F-00M-144-102	VR-B118B	6
1-197-311-031	VR-B202	13	1197311543	VR-B543B	24	F-00M-144-103	VR-B268	20
1197311032	VR-B260	18	1197311545	VR-B238	16	F-00M-144-106	VR-B122B	6
1197311033	VR-B260	18	1197311545	VR-B238	16	F-00M-144-107	VR-B396	24
1197311034	VR-B202L	14	1197311548	VR-B222	16	F-00M-144-108	VR-B132	7

CROSS REFERENCE
Voltage Regulator

CROSS REFERENCE
Rectifier

CROSS REFERENCE
Diode Trio

ALTERNATOR NO.
Reg & Rec

**CROSS REFERENCE
Voltage Regulator**

OEM No. → Mobiletron No.

OEM No.	Part No.	Page	OEM No.	Part No.	Page	OEM No.	Part No.	Page
F00M144109	VR-B160	8	F-00M-145-276	VR-B242	16	F-00M-145-384	VR-B254	17
F-00M-144-111	VR-B251	17	F-00M-145-278	VR-B278	20	F-00M-145-385	VR-B385	23
F-00M-144-118	VR-B118B	6	F00M145279	VR-B369	22	F-00M-145-387	VR-B251	17
F-00M-144-119	VR-B268	20	F-00M-145-280	VR-B280	20	F-00M-145-388	VR-B251	17
F-00M-144-122	VR-B122B	6	F-00M-145-281	VR-B252	17	F-00M-145-389	VR-B255	18
F-00M-144-123	VR-B396	24	F-00M-145-281	VR-B363	22	F00M145392	VR-B243	16
F-00M-144-128	VR-B271	20	F-00M-145-282	VR-B252	17	F00M145394	VR-B270	20
F-00M-144-129	VR-B129	7	F00M145283	VR-B371	22	F-00M-145-396	VR-B296	21
F-00M-144-131	VR-B131	7	F-00M-145-285	VR-B285	21	F-00M-145-397	VR-B296	21
F-00M-144-132	VR-B132	7	F00M145286	VR-B270	20	F-00M-145-426	TB-B001	4
F-00M-144-136	VR-B254	17	F-00M-145-287	VR-B414	24	F-00M-145-477	TB-B001	4
F-00M-144-138	VR-B247	17	F-00M-145-292	VR-B132	7	F-00M-145-665	VR-B150	7
F-00M-144-140	VR-B363	22	F-00M-145-293	VR-B385	23	F-00M-145-675	VR-B252	17
F-00M-144-142	VR-B252	17	F-00M-145-294	VR-B122B	6	F-00M-145-678	VR-B278	20
F-00M-144-143	VR-B414	24	F-00M-145-295	VR-B295	21	F-00M-145-679	VR-B280	20
F-00M-144-146	VR-B247	17	F-00M-145-295	VR-B242	16	F-00M-145-680	VR-B252	17
F-00M-144-147	VR-B385	23	F-00M-145-296	VR-B296	21	F-00M-145-696	VR-B314	21
F-00M-144-150	VR-B150	7	F-00M-145-297	VR-B268	20	F-00M-145-698	VR-B150	7
F-00M-144-154	VR-B271	20	F-00M-145-298	VR-B396	24	F-00M-145-852	VR-B378	23
F-00M-144-157	VR-B885	27	F-00M-145-299	VR-B118B	6	F-00M-145-858	VR-B131	7
F-00M-144-158	VR-B378	23	F-00M-145-300	VR-B122B	6	F-00M-145-861	VR-B861	26
F00M144160	VR-B160	8	F-00M-145-302	VR-B396	24	F-00M-145-862	VR-B296	21
F00M144171	VR-B371	22	F-00M-145-303	VR-B131	7	F00M145865	VR-B243	16
F-00M-144-175	VR-B300	21	F-00M-145-304	VR-B131	7	F00M145873	VR-B243	16
F-00M-144-177	VR-B252	17	F00M145305	VR-B243	16	F00M145874	VR-B243	16
F-00M-144-181	VR-B242	16	F-00M-145-307	VR-B396	24	F-00M-145-876	VR-B296	21
F-00M-144-182	VR-B252	17	F-00M-145-309	VR-B885	27	F-00M-145-880	VR-B880	27
F00M144183	VR-B253	17	F-00M-145-311	VR-B379	23	F-00M-145-881	VR-B657	25
F-00M-144-185	VR-B131	7	F-00M-145-312	VR-B880	27	F-00M-145-883	VR-B883	27
F-00M-144-188	VR-B131	7	F-00M-145-314	VR-B314	21	F-00M-145-884	VR-B132	7
F-00M-144-193	VR-B131	7	F-00M-145-315	VR-B300	21	F-00M-145-885	VR-B885	27
F-00M-144-197	VR-B4197	24	F-00M-145-315	VR-B271	20	F-00M-145-886	VR-B378	23
F00M144668	VR-B371	22	F-00M-145-321	VR-B131	7	F-00M-145-891	VR-B271	20
F-00M-145-073	VR-B259	18	F-00M-145-322	VR-B322	22	F-00M-145-891	VR-B300	21
F-00M-145-136	VR-B254	17	F-00M-145-323	VR-B150	7	F00M225200	VR-B394	23
F-00M-145-156	VR-B132	7	F00M145324	VR-B243	16	F00M225201	VR-B257	18
F-00M-145-195	VR-B271	20	F-00M-145-325	VR-B363	22	F00M225401	VR-B257	18
F-00M-145-200	VR-B271	20	F-00M-145-328	VR-B314	21	F00M255200	VR-B394	23
F-00M-145-200	VR-B254	17	F-00M-145-329	VR-B252	17	F00M255201	VR-B394	23
F-00M-145-201	VR-B252	17	F-00M-145-330	VR-B330	22	F00M255202	VR-B394	23
F-00M-145-206	VR-B255	18	F-00M-145-331	VR-B247	17	F-00M-255-204	VR-B5204	24
F-00M-145-207	VR-B267	19	F-00M-145-333	VR-B271	20	F-00M-346-005	VR-B056	5
F-00M-145-208	VR-B221	15	F00M145334	VR-B243	16	F-00M-346-008	VR-B021	4
F-00M-145-208	VR-B221	15	F00M145334	VR-B243	16	F-00M-346-010	VR-B026	4
F-00M-145-209	VR-B254	17	F-00M-145-335	VR-B131	7	F-00M-346-011	VR-B340	22
F-00M-145-210	VR-B221	15	F-00M-145-337	VR-B254	17	F-00M-346-013	VR-B033	4
F00M145214	VR-B253	17	F-00M-145-340	VR-B861	26	F-00M-346-014	VR-B088	5
F-00M-145-220	VR-B256	18	F-00M-145-341	VR-B296	21	F-00M-346-015	VR-B026	4
F-00M-145-223	VR-B271	20	F-00M-145-344	VR-B271	20	F-00M-346-019	VR-B056	5
F-00M-145-224	VR-B259	18	F00M145345	VR-B160	8	F-00M-346-020	VR-B020	4
F-00M-145-225	VR-B254	17	F-00M-145-346	VR-B255	18	F-00M-346-021	VR-B021	4
F-00M-145-226	VR-B372	22	F-00M-145-347	VR-B267	19	F-00M-346-023	VR-B057	5
F-00M-145-227	VR-B265	19	F00M145348	VR-B253	17	F-00M-346-024	VR-B033	4
F00M145228	VR-B371	22	F-00M-145-349	VR-B256	18	F-00M-346-025	VR-B088	5
F-00M-145-229	VR-B221	15	F-00M-145-350	VR-B254	17	F-00M-346-026	VR-B026	4
F-00M-145-230	VR-B221	15	F-00M-145-351	VR-B221	15	F-00M-346-029	VR-B029	4
F-00M-145-231	VR-B252	17	F-00M-145-351	VR-B221	15	F-00M-346-030	VR-B340	22
F-00M-145-234	VR-B271	20	F-00M-145-352	VR-B221	15	F-00M-346-032	VR-B088	5
F00M145236	VR-B243	16	F-00M-145-354	VR-B271	20	F-00M-346-033	VR-B033	4
F-00M-145-237	VR-B271	20	F-00M-145-354	VR-B271	20	F-00M-346-036	VR-B020	4
F-00M-145-238	VR-B271	20	F-00M-145-355	VR-B271	20	F-00M-346-037	VR-B021	4
F-00M-145-239	VR-B251	17	F-00M-145-357	VR-B247	17	F-00M-346-047	VR-B021	4
F-00M-145-240	VR-B255	18	F-00M-145-358	VR-B264	19	F-00M-346-048	VR-B020	4
F-00M-145-241	VR-B259	18	F00M145360	VR-B360	22	F-00M-346-053	VR-B029	4
F-00M-145-244	VR-B244	17	F-00M-145-361	VR-B262	19	F-00M-346-056	VR-B056	5
F-00M-145-246	VR-B268	20	F-00M-145-363	VR-B363	22	F-00M-346-057	VR-B057	5
F-00M-145-247	VR-B247	17	F00M145364	VR-B371	22	F-00M-346-061	VR-B066	5
F-00M-145-248	VR-B264	19	F-00M-145-365	VR-B883	27	F-00M-346-066	VR-B066	5
F-00M-145-249	VR-B363	22	F-00M-145-366	VR-B266	19	F-00M-346-074	VR-B057	5
F-00M-145-250	TB-B001	4	F-00M-145-367	VR-B385	23	F-00M-346-080	VR-B021	4
F00M145251	VR-B360	22	F-00M-145-368	VR-B242	16	F-00M-346-081	VR-B020	4
F-00M-145-252	VR-B263	19	F00M145369	VR-B369	22	F-00M-346-087	VR-B026	4
F00M145254	VR-B360	22	F-00M-145-370	VR-B252	17	F-00M-346-088	VR-B088	5
F-00M-145-255	VR-B262	19	F00M145371	VR-B371	22	F-00M-346-089	VR-B033	4
F-00M-145-256	VR-B396	24	F-00M-145-372	VR-B414	24	F-00M-346-092	VR-B092	6
F-00M-145-257	VR-B252	17	F-00M-145-374	VR-B132	7	F-00M-346-097	VR-B056	5
F-00M-145-260	VR-B363	22	F-00M-145-375	VR-B242	16	F-00M-346-098	VR-B057	5
F-00M-145-261	VR-B296	21	F-00M-145-375	VR-B295	21	F-00M-346-102	VR-B340	22
F-00M-145-262	VR-B880	27	F00M145376	VR-B243	16	F-00M-346-112	VR-B112	6
F00M145265	VR-B371	22	F-00M-145-377	VR-B885	27	F-00M-346-122	VR-B056	5
F-00M-145-266	VR-B883	27	F-00M-145-378	VR-B378	23	F-00M-346-131	VR-B056	5
F-00M-145-267	VR-B118B	6	F-00M-145-379	VR-B379	23	F-00M-346-135	VR-B135	7
F-00M-145-269	VR-B255	18	F-00M-145-380	VR-B150	7	F-00M-346-136	VR-B029	4
F-00M-145-271	VR-B266	19	F-00M-145-382	VR-B247	17	F-00M-346-137	VR-B137	7
F-00M-145-272	VR-B385	23	F-00M-145-383	VR-B271	20	F-00M-346-139	VR-B092	6

**CROSS REFERENCE
Voltage Regulator**

OEM No. → Mobiletron No.

OEM No.	Part No.	Page	OEM No.	Part No.	Page	OEM No.	Part No.	Page
F-00M-346-151	VR-B6151	24	10453673	VR-D231	30	13001740	VR-D669C	33
F-00M-346-152	VR-B6164	25	10458198	VR-D238	31	13472406	VR-D668C	33
F-00M-346-163	VR-B6164	25	10458198	VR-D231	30	13472557	VR-D673C	33
F-00M-346-164	VR-B6164	25	10458201	VR-D747HD	38	15063025	VR-D233	30
F-00M-346-165	VR-B057	5	10458202	VR-D233	30	15095471	VR-D481	32
F-00M-346-166	VR-B056	5	10459481	VR-D481	32	15098392	VR-D481	32
F-00M-346-340	VR-B340	22	10459482	VR-D481	32	15100053	VR-D481	32
F-00M-A45-207	VR-B221	15	10459483	VR-D481	32	15163024	VR-D233	30
F-00M-A45-208	VR-B271	20	10459596	VR-D481	32	15178637	VR-D481	32
F-00M-A45-209	VR-B271	20	10475019	VR-D701	36	15183649	VR-D481	32
F-00M-A45-210	VR-B262	19	10483643	VR-D235SE	30	15183650	VR-D481	32
F00MA45211	VR-B369	22	10483777	VR-D238	31	15183651	VR-D481	32
F-00M-A45-212	VR-B379	23	10483777	VR-D231	30	15188853	VR-D481	32
F-00M-A45-213	VR-B255	18	10483778	VR-D231	30	15188854	VR-D481	32
F-00M-A45-218	VR-B278	20	10483778	VR-D238	31	16003652	VR-D668C	33
F-00M-A45-219	VR-B280	20	10484046	VR-D234	30	1876388	VR-D669C	33
F-00M-A45-220	VR-B378	23	10486311	VR-D235SE	30	1894460	VR-D696B	36
F-00M-A45-221	VR-B880	27	10493240	VR-D711	37	1894489	VR-D686	35
F-00M-A45-228	VR-B267	19	10494747	VR-D747HD	38	19009701	VR-D701	36
F-00M-A45-231	VR-B363	22	10503579	VR-D579H	32	19009702	VR-D702H	36
F-00M-A45-232	VR-B254	17	10517755	VR-D755	38	19009703	VR-D703H	36
F00MA45233	VR-B270	20	10521033	VR-D1033	30	19009705	VR-D705H	36
F-00M-A45-234	VR-B251	17	10527282	VR-D282	31	19009706	VR-D706H	36
F00MA45236	VR-B360	22	10529295	VR-D295	31	19009708	VR-D711	37
F-00M-A45-237	VR-B242	16	1105510	VR-D696B	36	19009710	VR-D412	31
F-00M-A45-238	VR-B255	18	1105510	VR-D672C	33	19009715	VR-D712	37
F-00M-A45-248	VR-B118B	6	1116360	VR-D669C	33	19009716	VR-D701	36
F-00M-A45-251	VR-B268	20	1116380	VR-D668C	33	19009718	VR-D707	37
F-00M-A45-252	VR-B122B	6	1116384	VR-D668C	33	19009719	VR-D702H	36
F-00M-A45-253	VR-B396	24	1116385	VR-D668C	33	19009729	VR-D709	37
F-00M-A45-300	VR-B300	21	1116387	VR-D668C	33	19009736	VR-D719	38
F-00M-A45-303	VR-B271	20	1116387H	VR-D668C	33	19009748	VR-D707	37
CASE			1116388	VR-D687	35	19009751	VR-D719	38
K262266	VR-LC111	80	1116388	VR-D696B	36	19020378	VR-D481	32
CATERPILLAR			1116388	VR-D672C	33	19020384	VR-D481	32
2P1699	VR-D001B	30	1116389	VR-D669C	33	19020385	VR-D481	32
3T6353	VR-D672C	33	1116390	VR-D669C	33	19020393	VR-D481	32
3T6354	VR-D672C	33	1116392	VR-D668C	33	19020394	VR-D481	32
6N1874	VR-D672C	33	1116404	VR-D696B	36	19020406	VR-D406B	31
7N7799	VR-D672C	33	1116405	VR-D696B	36	19020810	VR-D481	32
9L6774	VR-D690	35	1116406	VR-D686	35	19020811	VR-D481	32
9N1207	VR-D672C	33	1116407	VR-D686	35	19020812	VR-D481	32
CHRYSLER			1116408	VR-D675H	34	19020813	VR-D481	32
1889960	VR-C524	28	1116411	VR-D694SE	36	19020816	VR-D481	32
2095700	VR-C524	28	1116411	VR-D694HD	36	19020817	VR-D481	32
2098300	VR-C524	28	1116412	VR-D412	31	19020818	VR-D481	32
2940030	VR-VW005N	122	1116413	VR-D681H	34	19053013	VR-D235SE	30
3000074	VR-C524	28	1116423	VR-D668C	33	19053730	VR-D235SE	30
3438150	VR-C545	28	1116424	VR-D424	31	19054622	VR-D235SE	30
3438150	VR-C545H	28	1116425	VR-D683H	35	19060319	VR-D235SE	30
3755850	VR-C545H	28	1116428	VR-D675H	34	19060319	VR-D235	30
3755850	VR-C545	28	1116429	VR-D694H	35	19060345	VR-D235	30
3755960	VR-C545	28	1116429	VR-D694HD	36	1984287	VR-D696B	36
3755960	VR-C545H	28	1116429	VR-D694SE	36	1984287	VR-D672C	33
3755970	VR-C545H	28	1116430	VR-D681H	34	1987518	VR-D696B	36
3874520	VR-C545H	28	1116432	VR-D432	31	1987518	VR-D687	35
3874520	VR-C545	28	1116433	VR-D680	34	1988988	VR-D677	34
4003708	VR-C545H	28	1116433	VR-D690	35	21226043	VR-D671C	33
4091050	VR-C545H	28	1116435	VR-D690	35	220116	VR-D502	32
4111990	VR-C545H	28	1116435	VR-D680	34	220736	VR-K09	78
4144187	VR-C545H	28	1116435	VR-D686	35	222727	VR-D186	30
5234625	VR-C545H	28	1116436	VR-D694SE	36	233738	VR-D668C	33
CH524	VR-C524	28	1116436	VR-D694HD	36	234058	VR-D691	35
CH537	VR-C545H	28	1116436	VR-D694H	35	234060	VR-D668B	32
CH543	VR-C545H	28	1116437	VR-D694H	35	235542	VR-D744	38
CH544	VR-C545H	28	1116437	VR-D694HD	36	235864	VR-D714SE	37
CH545	VR-C545H	28	1116437	VR-D694SE	36	236563	VR-D745	38
CITROEN			1116438	VR-D682	35	271940	VR-D740	38
5491551	VR-DU510	120	1116439	VR-D682	35	276010	VR-D276	29
9405761558	VR-B196MH	11	1116439	VR-D694H	35	3293030	VR-D674H	34
9405761798	VR-PR1926	126	1116439	VR-D694SE	36	3472406	VR-D668C	33
95546007	VR-DU511	120	1116439	VR-D694HD	36	3472557	VR-D673C	33
AK5351	VR-DU510	120	1116440	VR-D694HD	36	3493029	VR-D674H	34
DAEWOO			1116440	VR-D694SE	36	3493029	VR-D674	33
271910	VR-D271	29	1116440	VR-D694H	35	3493030	VR-D674	33
276010	VR-D276	29	1116440	VR-D440	31	3493050	VR-D673C	33
93740796	VR-D271	29	1116441	VR-D682	35	3493079	VR-D674	33
DAD25006D	VR-K04	29	1116442	VR-D680	34	3493079	VR-D674H	34
DAF			1116442	VR-D690	35	3493080	VR-D674H	34
1600348	VR-B396	24	1116445	VR-D445	32	3493080	VR-D674	33
DAIHATSU			1116446	VR-D602H	32	6159599	VR-D680	34
27700-87207	VR-H2005-39	52	1119506	VR-D635	32	7896932	VR-D668C	33
27700-96301	VR-H2005-39	52	1119512	VR-D635	32	7934605	VR-D670C	33
DELCO			1119515	VR-D635	32	7934614	VR-D670C	33
10453673	VR-D238	31	1119519	VR-D635	32	7982685	VR-D671C	33

CROSS REFERENCE
Voltage Regulator

CROSS REFERENCE
Rectifier

CROSS REFERENCE
Diode Trio

ALTERNATOR NO.
Reg & Rec

**CROSS REFERENCE
Voltage Regulator**

OEM No. → Mobiletron No.

OEM No.	Part No.	Page	OEM No.	Part No.	Page	OEM No.	Part No.	Page
7982866	VR-D670C	33	126000-0360	VR-H2005-28	50	126000-1809	VR-H2005-3	51
9009353	VR-B193M	10	126000-0371	VR-H2005-14H	43	126000-1860	VR-H2005-10	41
90487255	VR-B200H	13	126000-0400	VR-H2005-4A	53	126000-1870	VR-H2005-63A	55
9315303	VR-D676	34	126000-0410	VR-H2005-7A	56	126000-1880	VR-H2005-10	41
9343233	VR-D669C	33	126000-0411	VR-H2005-7A	56	126000-1920	VR-H2005-48A	53
9345333	VR-D676	34	126000-0420	VR-H2005-37A	52	126000-1930	VR-H2005-30A	51
94648534	VR-D690	35	126000-0430	VR-H2005-5H	54	126000-1940	VR-H2005-59	54
94652566	VR-D100	30	126000-0440	VR-H2005-6H	55	126000-1960	VR-H2005-30A	51
D600A	VR-D681H	34	126000-0450	VR-H2005-3	51	126000-1970	VR-H2005-48A	53
D602A	VR-D602H	32	126000-0460	VR-H2005-28	50	126000-1971	VR-H2005-48A	53
D635	VR-D635	32	126000-0470	VR-H2005-7A	56	126000-1977	VR-H2005-48A	53
D663	VR-D635	32	126000-0490	VR-H2005-3	51	126000-2050	VR-H2005-46A	53
D668	VR-D668C	33	126000-0500	VR-H2005-28	50	126000-2070	VR-H2005-162B	44
D672	VR-D686	35	126000-0510	VR-H2005-4A	53	126000-2090	VR-H2005-40	53
D674	VR-D677	34	126000-0520	VR-H2005-11	42	126000-2100	VR-H2005-196	47
D675	VR-D675H	34	126000-0540	VR-H2005-9A	58	126000-2120	VR-H2005-26A	50
D677	VR-D694H	35	126000-0550	VR-H2005-23A	50	126000-2150	VR-H2005-77	56
D677	VR-D694SE	36	126000-0570	VR-H2005-8	56	126000-2151	VR-H2005-77	56
D677	VR-D694HD	36	126000-0600	VR-H2005-39SE	52	126000-2160	VR-H2005-40	53
D678	VR-D678H	34	126000-0600	VR-H2005-39	52	126000-2170	VR-H2005-40	53
D680	VR-D668C	33	126000-0610	VR-H2005-33A	51	126000-2181	VR-H2005-59	54
D681	VR-D681H	34	126000-0650	VR-H2005-4A	53	126000-2190	VR-H2005-64A	55
D683	VR-D683H	35	126000-0670	VR-H2005-28	50	126000-2200	VR-H2005-46A	53
D684	VR-D678H	34	126000-0700	VR-H2005-4A	53	126000-2200	VR-H2005-30A	51
D685	VR-D694HD	36	126000-0720	VR-H2005-26A	50	126000-2230	VR-H2005-46A	53
D685	VR-D694SE	36	126000-0721	VR-H2005-26A	50	126000-2250	VR-H2005-30A	51
D685	VR-D694H	35	126000-0731	VR-H2005-4A	53	126000-2260	VR-H2005-63A	55
D686	VR-D680	34	126000-0732	VR-H2005-4A	53	126000-2290	VR-H2005-31A	51
D686	VR-D690	35	126000-0760	VR-H2005-39SE	52	126000-2340	VR-H2005-58	54
D687	VR-D690	35	126000-0770	VR-H2005-11	42	126000-2400	VR-H2005-52A	54
D690	VR-D690	35	126000-0820	VR-H2005-11	42	126000-2470	VR-H2005-40	53
D698	VR-D694H	35	126000-0840	VR-H2005-25	50	126000-2480	VR-H2005-172	45
D698	VR-D694SE	36	126000-0850	VR-H2005-24	50	126000-2490	VR-H2005-87	57
D698	VR-D694HD	36	126000-0880	VR-H2005-24	50	126000-2610	VR-H2005-40	53
D699	VR-D675H	34	126000-0900	VR-H2005-23A	50	126000-2650	VR-H2005-140	42
DR600	VR-D668C	33	126000-0901	VR-H2005-23A	50	126000-2680	VR-H2005-48A	53
DR666	VR-D668C	33	126000-0920	VR-H2005-2	48	126000-2740	VR-H2005-48A	53
DR667	VR-D668C	33	126000-0920	VR-H2005-2W	51	126000-2810	VR-H2005-26A	50
DR668	VR-D668C	33	126000-0931	VR-H2005-4A	53	126000-2861	VR-H2005-62A	55
DR669	VR-D669C	33	126000-0932	VR-H2005-4A	53	126000-2871	VR-H2005-82	56
DR680	VR-D668C	33	126000-0940	VR-H2005-10	41	126000-2890	VR-H2005-165	44
DVR202	VR-D680	34	126000-0950	VR-H2005-26A	50	126000-2931	VR-H2005-187	46
JFZ1621-530	VR-Y002	39	126000-0970	VR-H2005-15H	44	126000-3020	VR-H2005-179	46
DELCO REMY (LUCAS)			126000-0980	VR-H2005-23A	50	126000-3021	VR-H2005-179	46
21220353	VR-DU511	120	126000-1010	VR-H2005-4A	53	126000-3040	VR-H2005-62A	55
21220383	VR-DU515	121	126000-1030	VR-H2005-10	41	126000-3060	VR-H2005-48A	53
21221347	VR-B193M	10	126000-1110	VR-H2005-33A	51	126000-3080	VR-H2005-208	49
21221350	VR-B198	12	126000-1130	VR-H2005-34	52	126000-3081	VR-H2005-208	49
21221416	VR-B196M	11	126000-1160	VR-H2005-39SE	52	126000-3170	VR-H2005-65	55
21221432	VR-B195M	11	126000-1160	VR-H2005-15H	44	126000-3171	VR-H2005-65	55
21222127	VR-F119	82	126000-1170	VR-H2005-9A	58	126000-3290	VR-H2005-200	48
21225422	VR-PR126	124	126000-1190	VR-H2005-18A	47	126000-3300	VR-H2005-173	45
21226104	VR-D673C	33	126000-1200	VR-H2005-16A	45	126000-3370	VR-H2005-197	47
21511114	VR-H2000-3	67	126000-1260	VR-H2005-18A	47	126000-3430	VR-H2005-40A	53
21513127	VR-H2009-16	94	126000-1270	VR-H2005-18A	47	126000-3450	VR-H2005-154	43
54048473	VR-LC111	80	126000-1300	VR-H2005-10	41	126000-3530	VR-H2005-48A	53
DENSO			126000-1330	VR-H2005-26A	50	126000-3690	VR-H2005-64A	55
101211-0690	VR-H2005-59	54	126000-1400	VR-H2005-17A	46	126000-3720	VR-H2005-105	42
101211-4280	VR-H2005-59	54	126000-1400	VR-H2005-18A	47	126000-3730	VR-H2005-151B	43
101211-9010	VR-H2005-59	54	126000-1410	VR-H2005-10	41	126000-3990	VR-H2005-185	46
101211-9020	VR-H2005-59	54	126000-1450	VR-H2005-4A	53	126000-4060	VR-H2005-178	45
101211-9940	VR-H2005-59	54	126000-1460	VR-H2005-2	48	126000-7010	VR-H2005-58	54
102211-1440	VR-H2005-59	54	126000-1460	VR-H2005-2W	51	126000-7011	VR-H2005-58	54
102211-1820	VR-H2005-59	54	126000-1470	VR-H2005-19A	48	126000-7090	VR-H2005-4A	53
102211-1830	VR-H2005-59	54	126000-1500	VR-H2005-18A	47	126000-7100	VR-H2005-31A	51
102211-9010	VR-H2005-59	54	126000-1520	VR-H2005-45A	53	126000-7100	VR-H2005-46A	53
104210-8070	VR-H2005-199	48	126000-1521	VR-H2005-45A	53	126000-7100	VR-H2005-35	52
122600-0140	VR-H2005-90	57	126000-1530	VR-H2005-4A	53	126000-7110	VR-H2005-31A	51
126000-0030	VR-H2005-1	41	126000-1540	VR-H2005-31A	51	126000-7120	VR-H2005-66	55
126000-0060	VR-H2005-1	41	126000-1550	VR-H2005-23A	50	126000-7160	VR-H2005-34	52
126000-0100	VR-H2005-1	41	126000-1560	VR-H2005-4A	53	126000-7320	VR-F164	45
126000-0101	VR-H2005-1	41	126000-1570	VR-H2005-23A	50	126000-959	VR-H2005-32A	51
126000-0120	VR-H2005-1	41	126000-1580	VR-H2005-31A	51	126220-0150	TB-ND160	40
126000-0140	VR-H2005-1	41	126000-1630	VR-H2005-32A	51	126220-0180	TB-ND097	40
126000-0141	VR-H2005-1	41	126000-1640	VR-H2005-31A	51	126220-0230	TB-ND167	40
126000-0170	VR-H2005-3	51	126000-1660	VR-H2005-31A	51	126600-0011	VR-H2005-89	57
126000-0180	VR-H2005-11	42	126000-1670	VR-H2005-46A	53	126600-0022	VR-H2005-93	58
126000-0200	VR-H2005-12	42	126000-1670	VR-H2005-31A	51	126600-0023	VR-H2005-93	58
126000-0270	VR-H2005-29	50	126000-1700	VR-H2005-10	41	126600-0030	VR-H2005-94	58
126000-0300	VR-H2005-37A	52	126000-1720	VR-H2005-10	41	126600-0031	VR-H2005-94	58
126000-0301	VR-H2005-37A	52	126000-1730	VR-H2005-30A	51	126600-0040	VR-H2005-99	58
126000-0302	VR-H2005-37A	52	126000-1740	VR-H2005-50A	54	126600-0041	VR-H2005-99	58
126000-0310	VR-H2005-1	41	126000-1750	VR-H2005-30A	51	126600-0042	VR-H2005-99	58
126000-0330	VR-H2005-4A	53	126000-1760	VR-H2005-34	52	126600-0090	VR-H2005-104	41
126000-0340	VR-H2005-4A	53	126000-1800	VR-H2005-60	54	126600-0110	VR-H2005-164A	44

**CROSS REFERENCE
Voltage Regulator**

OEM No. → Mobiletron No.

OEM No.	Part No.	Page	OEM No.	Part No.	Page	OEM No.	Part No.	Page
126600-0149	VR-H2005-90	57	GRO12X-1	VR-DU510	120	74GB-10316AA	VR-B193M	10
126600-0150	VR-H2005-91	57	GRO12-X1Y	VR-F110A	82	77BB-10316AA	VR-VW002	122
126600-0520	VR-H2005-100	41	GRO12-X30	VR-F110A	82	78GB-10316AA	VR-B193M	10
126600-0530	VR-H2005-144	42	GRO12X-9	VR-DU510	120	80BB-10316AA	VR-VW003	122
126600-0540	VR-H2005-100	41	RFH12-11	VR-F110A	82	81DB-10316CA	VR-LC200	81
126600-1890	VR-H2005-166	44	RFH12-7	VR-F110A	82	81DB-110316AA	VR-B193M	10
126600-3000	VR-H2005-146	43	RFH24-4	VR-F110B	82	82BB-10316AA	VR-B195M	11
126600-3010	VR-H2005-85	56	FENDT			84AB-10316AA	VR-LC111	80
126600-3020	VR-H2005-95	58	K830060011010	VR-B193M	10	86GB10316AA	VR-B196M	11
126600-3040	VR-H2005-85	56	FERRARI			86GB-10316AA	VR-B196MH	11
126600-3070	VR-H2005-99	58	0121840	VR-B196M	11	8V21-10300BB	VR-V4291	116
126600-3080	VR-H2005-152	43	FIAT			9G9N-10300CA	VR-V4291	116
126600-3150	VR-H2005-99	58	4074763	VR-F110A	82	A830X-10316FA	VR-B193M	10
126600-3200	VR-H2005-90	57	4087071	VR-F110B	82	BF0A-10376AA	VR-VN005	131
126600-3220	VR-H2005-95	58	4095889	VR-F110A	82	BL1T-10300BB	VR-H2009-140	92
126600-3230	VR-H2005-146	43	4095898	VR-F110A	82	BL1Z-10346A	VR-H2009-140	92
126600-3240	VR-H2005-101	41	4112453	VR-F110B	82	CN15-10316AA	VR-B056	5
126600-3290	VR-H2005-163	44	4191122	VR-F110A	82	D9PZ-10316A	VR-F540A	59
126600-3320	VR-H2005-95	58	4202969	VR-F110A	82	E0DZ-10316A	VR-F786SE	60
126600-3350	VR-H2005-90	57	4205243	VR-F110B	82	E0DZ-10316A	VR-F786H	59
126600-3360	VR-H2005-85	56	4215948	VR-F110B	82	E0DZ-10316A	VR-F786BH	59
126600-3390	VR-H2005-85	56	4224467	VR-B191	9	E27Z-10316A	VR-H2009	87
126600-3430	VR-H2005-96	58	4224467	VR-B190	8	E2PZ-10316A	VR-F540A	59
126600-3440	VR-H2005-101	41	42490291	VR-B193M	10	E3NN-10B376AD	VR-LC113L	81
126600-3460	VR-H2005-88	57	4288170	VR-F110B	82	E43F-10316A	VR-F784H	59
126600-3490	VR-H2005-150	43	4296100	VR-F110A	82	E43F-10316AA	VR-F784M	59
126600-3600	VR-H2005-177	45	4296659	VR-F110B	82	E43F-10316AA	VR-F784H	59
126600-3640	VR-H2005-96	58	4474531	VR-F110B	82	E43Z-10316A	VR-F784H	59
126600-3650	VR-H2005-149	43	4474566	VR-F110A	82	E43Z-10316A	VR-F784M	59
126600-3660	VR-H2005-148	43	4474755	VR-B193M	10	E43Z-10316B	VR-F784M	59
126600-3800	VR-H2005-95	58	4475112	VR-F114A	82	E43Z-10316B	VR-F784H	59
126600-3970	VR-H2005-190	47	4475269	VR-B192	9	E4AZ-10316B	VR-F540A	59
126600-4210	VR-H2005-177	45	4701050	VR-F110B	82	E5RD-10316BA	VR-B195M	11
126600-4310	VR-H2005-101	41	4701484	VR-B197	12	E63F-10316AA	VR-F784M	59
126600-4360	VR-H2005-178	45	4721593	VR-F114A	82	E63F-10316AA	VR-F784H	59
126600-4490	VR-H2005-107	42	4731653	VR-B193M	10	E63F-10316AB	VR-F784H	59
126600-7120	VR-H2005-171	45	4754010	VR-F110B	82	E63F-10316AB	VR-F784M	59
126600-7170	VR-H2005-171	45	5011933	VR-F110A	82	E6DF-10316AA	VR-F540DH	59
126600-7240	VR-F161	45	60743883	VR-B196M	11	E6TZ-10316A	VR-F784M	59
126600-7320	VR-F164	45	60743997	VR-B195M	11	E6TZ-10316A	VR-F784H	59
126601-7220	VR-F169	45	60751439	VR-B195M	11	E6YZ-10316A	VR-F784H	59
126601-7230	VR-F163	45	77365937	VR-B704	25	E73F-10316AB	VR-F784H	59
236329	VR-H2005-146	43	79022473	VR-B197	12	E73F-10316AC	VR-F784H	59
3570	VR-H2005-194	47	8190407	VR-F119B	83	E73Z-10316A	VR-F784H	59
7310	VR-H2005-184	46	82302913	VR-B193M	10	E7GZ-10316A	VR-H2009-9H	109
7390	VR-H2005-183	46	9927829	VR-B192	9	E7NN-10316AA	VR-LC113L	81
7420	VR-H2005-184	46	9933186	VR-B193M	10	E8GY-10316	VR-H2009-4H	102
7511	VR-H2005-206	48	9934791	VR-B192	9	E8GY-10316B	VR-H2009-7H	106
7541	VR-H2005-210	49	9936532	VR-B193M	10	E8GZ-10316A	VR-H2009-7H	106
7730	VR-H2005-206	48	9938171	VR-B195M	11	E8JY-10316	VR-H2009-4H	102
GC5B 3950	VR-H2005-96	58	9939826	VR-F119	82	E8PZ-10313A	VR-H2009-11H	90
GC5B 3960	VR-H2005-177	45	9940343	VR-B193M	10	E8PZ-10316A	VR-H2009-11H	90
GC5B 4200	VR-H2005-96	58	9941193	VR-F119	82	E8PZ-10316B	VR-H2009-10A	88
GC5B 5110	VR-H2005-96	58	9942848	VR-B195M	11	E9DF-10316AA	VR-F786M	60
GC5B 5120	VR-H2005-177	45	9942885	VR-B195M	11	E9DF-10316AA	VR-F786H	59
GL3 0110	VR-H2005-177	45	9946542	VR-F151A	83	E9DF-10316AA	VR-F786SE	60
GL6A 4430	VR-H2005-107	42	9946618	VR-F121T	83	E9DF-10316AA	VR-F786BH	59
GL6A3 4500	VR-H2005-107	42	9949575	VR-B252	17	E9JY-10316A	VR-B391	23
GL6A3 4520	VR-H2005-107	42	9950085	VR-B193M	10	E9PZ10316AA	VR-H2009-15	93
IFX 8150	VR-H2005-214	49	9950586	VR-F121T	83	E9PZ-10316B	VR-H2009-25	99
IFX1 7510	VR-H2005-219	49	9959694	VR-F114B	82	F02Z-10316A	VR-H2009-26	99
IFX1 7740	VR-H2005-215	49	9960176	VR-B195M	11	F0BZ-10316A	VR-H2009-24	99
IFX1 7841	VR-H2005-218	49	9983355	VR-F114B	82	F0BZ-10316A	VR-H2009-9H	109
N810F01288	VR-H2005-83	56	9988935	VR-B197	11	F0DZ-10316A	VR-F786M	60
PCM-01	VR-H2005-88	57	FORD			F3AU-10316AA	VR-F811	60
ST17001	VR-H2005-83	56	11436766	VR-B191	9	F3AZ-10316A	VR-F811	60
ELMOT			11436766	VR-B190	8	F3AZ-10316A	VR-F811	60
RC128	VR-F110B	82	11444238	VR-B190	8	F3AZ-10316A	VR-F811BH	60
RC212B	VR-F110A	82	11444238	VR-B191	9	F3AZ-10346A	VR-F811BH	60
RC212D	VR-F110A	82	11444273	VR-B191	9	F3AZ-10346A	VR-F811	60
RC212E	VR-F110A	82	11444273	VR-B190	8	F3RU-10316AA	VR-F811	60
RC224	VR-F110B	82	11635831	VR-B199-3	12	F3RU-10316AA	VR-F811BH	60
FAUN			1477502	VR-B192	9	F4RU-10316AA	VR-F818	61
1713068	VR-B191	9	1591687	VR-LC200	81	F4ZZ-10316A	VR-F814	60
1713068	VR-B190	8	1640169	VR-B195M	11	F50U-100359AA	VR-F815	60
1713071	VR-B199-4	13	5011364	VR-B193M	10	F50U-10316A	VR-F815	60
FEMSA			6036646	VR-B193M	10	F50U-10C359AB	VR-F815	60
GRK12-13	VR-DU510	120	6048270	VR-VW002	122	F5RU-10316A	VR-F818	61
GRK12-2	VR-DU510	120	6057627	VR-B193M	10	F5RU-10316BA	VR-F818	61
GRK12X-1	VR-DU510	120	6073340	VR-VW003	122	F5RZ-10316A	VR-F818	61
GRO12-10	VR-DU509	120	6094906	VR-B198	12	F6DU-10C359AA	VR-F817	60
GRO12-12	VR-DU509	120	6113735	VR-B195M	11	F6DY-10316A	VR-F817	60
GRO12-2	VR-DU510	120	6133746	VR-LC111	80	F8WU-10C359AB	VR-F900	61
GRO12-3Y	VR-F110A	82	6165056	VR-B196MH	11	GR748B	VR-F784H	59
GRO12-7	VR-DU509	120	71BB-10316AA	VR-B192	9	GR784	VR-F784H	59

CROSS REFERENCE
Voltage Regulator

CROSS REFERENCE
Rectifier

CROSS REFERENCE
Diode Trio

ALTERNATOR NO.
Reg & Rec

**CROSS REFERENCE
Voltage Regulator**

OEM No. → Mobiletron No.

OEM No.	Part No.	Page	OEM No.	Part No.	Page	OEM No.	Part No.	Page
GR784A	VR-F784H	59	L170G-6315	VR-H2000-38	68	31150-PM4-003	VR-H2005-10	41
GR784B	VR-F784H	59	L170G-6315	VR-H2000-42	69	31150-R1A-A01	VR-H2009-171	95
GR811	VR-F811	60	L170G-7315	VR-H2000-41	69	31150-RAA-A010M	VR-H2005-90	57
GR817	VR-F817	60	L170G-7315	VR-H2000-53	71	31150-RAA-A030M	VR-H2005-90	57
GRE792	VR-H2009-11H	90	L180-3315	VR-H2000-4H	70	31150-RB0-004	VR-H2009-139	92
GRE793	VR-H2009-10A	88	L180-5340	VR-H2000-18	65	31150-REA-Z01	VR-H2009-144	92
GRE799	VR-H2009-26	99	L180-7315	VR-H2000-7H	72	31150-RNA-A01	VR-H2009-113	89
VP3C3U-10C359AA	VR-F901	61	L180-8315	VR-H2000-17	65	31400-SA5-004	VR-H2005-37A	52
VP4L1U-10C359AA	VR-F931	62	L180G-2315	VR-H2000-65	72	31400-SA5-671	VR-H2005-37A	52
VP4L2U-10316AA	VR-F786HC	59	L180G-2340	VR-H2000-16	65	31400-SA5-A0300	VR-H2005-37A	52
VP4L2U-10C359AA	VR-F821	61	L180G-23401	VR-H2000-42	69	31400-SB0-004	VR-H2005-37A	52
VP4L3U-10C359AA	VR-F910	61	L180G-23401	VR-H2000-38	68	HYUNDAI		
VP6L8U-10C359AA	VR-F822	61	L180G-6340	VR-H2000-16	65	37370-02500	VR-H2009-187	75
VPF1U-10C359AA	VR-F910	61	L180G-63401	VR-H2000-88	73	37370-21200	VR-H2009-4H	102
XS7U-10C359AC	VR-F920	61	L180G-63401	VR-H2000-62	71	37370-21330	VR-H2009-187	75
XS7U-10C359BA	VR-F930	61	L180G-7340	VR-H2000-16	65	37370-22600	VR-MD06	86
XW4U-10C359AB	VR-F910	61	L180G-9340	VR-H2000-18	65	37370-22650	VR-PR5023	129
GM			L185G-4340	VR-H2000-27	66	37370-24510	VR-H2009-187	75
10493240	VR-D711	37	L185G-5340	VR-H2000-62	71	37370-38310	VR-MD08	86
140475019	VR-D701	36	L190-3315	VR-H2000-4H	70	37370-42300	VR-H2009-128	91
19116396	VR-D481	32	L190-4315	VR-H2000-20	66	37370-45100	VR-H2009-191B	97
220737	VR-D737	38	L190G-5340	VR-H2000-43	69	37370-72000	VR-MD13B	75
3474557	VR-D673C	33	L190G-7340	VR-H2000-42	69	37370-8Y020	VR-MD13B	75
90009353	VR-B193M	10	L190G-8340	VR-H2000-88	73	IHC		
90349704	VR-B195M	11	L190G-8340	VR-H2000-62	71	3055449R91	VR-B199-3	12
90349907	VR-B195M	11	L195G-2340	VR-H2000-23	66	3079037R91	VR-B193M	10
91174657	VR-H2009-90	108	L225-8315	VR-H2000-29B	67	3079123R91	VR-B193M	10
93173428	VR-B371	22	L225-8315	VR-H2000-29BC	67	3079147R91	VR-B197	12
93176049	VR-B371	22	L225-8315	VR-H2000-29BA-2	67	3079392R91	VR-B198	12
94139012	VR-H2005-4A	53	TR1Z-108	VR-H2000-39	69	3079412R92	VR-B194	10
94167410	VR-H2000-29	66	TR1Z-108B	VR-H2000-39	69	3132862R1	VR-B199-3	12
94167410	VR-H2000-29C	67	TR1Z-125	VR-D712	37	3136411R92	VR-B190	8
94167410	VR-H2000-29A-2	67	TR1Z-210A	VR-H2000-8	72	3136411R92	VR-B191	9
94167410	VR-H2000-29C	67	TR1Z-210B	VR-H2000-8	72	3144046R1	VR-B191	9
94840314	VR-H2005-4A	53	TR1Z-27	VR-H2000-1L	65	3144046R1	VR-B190	8
96052000	VR-H2005-7A	56	TR1Z-27	VR-H2000-1H	65	3144931R1	VR-B199-4	13
HINO			TR1Z-27	VR-H2000-1	64	ISEKI		
27700-1210B	VR-H2001-2	63	TR1Z-27	VR-H2000-32	68	281-271-001-0	VR-H2005-39	52
27700-1370	VR-H2001-3	63	TR1Z-28	VR-H2000-32	68	6581-270-004-0	VR-H2000-2	66
27700-1480A	VR-H2001-1	63	TR1Z-33	VR-H2000-32	68	ISKRA		
27700-1510	VR-H2001-3	63	TR1Z-33	VR-H2000-1	64	10-120-110	VR-B193M	10
27700-1700	VR-H2002-1	111	TR1Z-33	VR-H2000-1H	65	11-125-003	VR-B193M	10
5140300610	VR-H2001-1	63	TR1Z-33	VR-H2000-1L	65	11-125-004	VR-B197	12
5140500411	VR-H2001-2	63	TR1Z-43	VR-H2000-3	67	11-125-009	VR-B191	9
HITACHI			TR1Z-44	VR-H2000-2	66	11-125-009	VR-B190	8
136284	VR-H2000-3	67	TR1Z-47	VR-H2000-1H	65	11-125-015	VR-B190	8
232443	VR-H2000-50	70	TR1Z-47	VR-H2000-1	64	11-125-015	VR-B191	9
234289	VR-H2000-48	70	TR1Z-47	VR-H2000-1L	65	11125019	VR-IK019	76
2500625	VR-B122B	6	TR1Z-47	VR-H2000-32	68	11-125-029	VR-IK029	76
IH746	VR-H2000-85	73	TR1Z-48	VR-H2000-32	68	11-125-040	VR-B193M	10
IH784	VR-H2000-72	72	TR1Z-48	VR-H2000-1L	65	11-125-047	VR-IK029	76
L1100G-3340	VR-H2000-28	66	TR1Z-48	VR-H2000-1	64	11-125-049	VR-B193M	10
L1100G-53402	VR-H2000-46	70	TR1Z-48	VR-H2000-1H	65	11125053	VR-IK019	76
L1100G-8340	VR-H2000-46	70	TR1Z-53	VR-H2000-3	67	11125054	VR-IK019	76
L1100G-9340	VR-H2000-28	66	TR1Z-56	VR-H2000-1H	65	11-125-055	VR-B197	12
L1110-2315	VR-H2000-26	66	TR1Z-56	VR-H2000-1	64	11125056	VR-IK019	76
L1110G-43402	VR-H2000-46	70	TR1Z-56	VR-H2000-1L	65	11125065	VR-IK019	76
L135-13152	VR-H2000-33	68	TR1Z-56	VR-H2000-32	68	11-125-073	VR-B193M	10
L135-43153	VR-H2000-34	68	TR1Z-62	VR-H2000-3	67	11125085	VR-IK019	76
L150-23155	VR-H2000-35	68	TR1Z-63	VR-H2000-2	66	11-125-087	VR-IK029	76
L150-33155	VR-H2000-29	66	TR1Z-64	VR-H2000-3	67	11-125-091	VR-F110B	82
L150-33155	VR-H2000-29A-2	67	TR1Z-65	VR-H2000-1H	65	11-125-094	VR-B194	10
L150-33155	VR-H2000-29C	67	TR1Z-65	VR-H2000-1	64	11-125-095	VR-B198	12
L150-43151	VR-H2000-37	68	TR1Z-65	VR-H2000-1L	65	11125097	VR-F119	82
L150-63151	VR-H2000-37	68	TR1Z-65	VR-H2000-32	68	11-125-106	VR-B191	9
L150-73154	VR-H2000-36	68	TR2Z-37	VR-H2000-3A	69	11-125-106	VR-B190	8
L150-93155	VR-H2000-30	68	TR2Z-47	VR-H2000-2B	67	11-125-109	VR-DU510	120
L160-43154	VR-H2000-5H	71	TR2Z-49	VR-H2000-3A	69	11-125-110	VR-F110A	82
L160-63153	VR-H2000-30	68	TR2Z-49	VR-H2000-29B	67	11-125-113	VR-PR1000H	124
L165-5315	VR-H2000-19	65	TR2Z-49	VR-H2000-29BA-2	67	11-125-117	VR-B193M	10
L165G-2315	VR-H2000-16	65	TR2Z-49	VR-H2000-29BC	67	11-125-121	VR-B193M	10
L170-1315	VR-H2000-6H	72	HONDA			11-125-122	VR-IK149	76
L170-23152	VR-H2000-15	64	31150-P2T-0030	VR-H2005-40	53	11-125-124	VR-IK02	76
L170-3315	VR-H2000-21	66	31150-PD1-004	VR-H2005-4A	53	11-125-124	VR-IK15	76
L170-33152	VR-H2000-14	64	31150-PD2-004	VR-H2005-4A	53	11125139	VR-IK019	76
L170-43151	VR-H2000-11	64	31150-PD6-004	VR-H2005-9A	58	11-125-149	VR-IK149	76
L170-53151	VR-H2000-5H	71	31150-PD6-014	VR-H2005-9A	58	11-125-165	VR-IK01	76
L170-6315	VR-H2000-13	64	31150-PD6-024	VR-H2005-9A	58	11125177	VR-IK019	76
L170G-1315	VR-H2000-40	69	31150-PDJ-004	VR-H2005-4A	53	11125199	VR-IK019	76
L170G-1315	VR-H2000-47	70	31150-PE0-003	VR-H2005-7A	56	11-201-293	VR-IK149	76
L170G-1315	VR-H2000-47C	70	31150-PE0-921	VR-H2005-6H	55	16-905-304	VR-IK029	76
L170G-3319	VR-H2000-41	69	31150-PE7-661	VR-H2005-8	56	16905323	VR-IK019	76
L170G-3319	VR-H2000-53	71	31150-PE7-6620	VR-H2005-8	56	16-906-352	VR-IK02	76
L170G-6308	VR-H2000-53	71	31150-PEO-9270	VR-H2009-32	100	16-906-481	VR-IK01	76
L170G-6308	VR-H2000-41	69	31150-PH3-013	VR-H2005-9A	58	235542	VR-D744	38

**CROSS REFERENCE
Voltage Regulator**

OEM No. → Mobiletron No.

OEM No.	Part No.	Page	OEM No.	Part No.	Page	OEM No.	Part No.	Page
AER1401	VR-IK019	76	37370-42000	VR-MD01	86	1221152	VR-B193M	10
AER1403	VR-B197	12	37370-42540	VR-MD01	86	21029141	VR-VW002	122
AER1404	VR-IK029	76	KK137-24-W70	VR-H2009-6HL	105	21129167	VR-LD150A	79
AER1406	VR-IK019	76	KLOCKNER-HUMBOLD-DEUTZ			21220253	VR-DU511	120
AER1503	VR-B193M	10	114440747	VR-B199-3	12	21220371	VR-DU512	120
AER1504	VR-B197	12	1160363EF8976	VR-B190	8	21220379	VR-DU513	121
AER1504	VR-IK029	76	1160363EF8976	VR-B191	9	21221125	VR-B197	12
AER1505	VR-IK019	76	1160363EF8976-1	VR-B191	9	2122121	VR-F119	82
AER1506	VR-IK019	76	1160363EF8976-1	VR-B190	8	21221347	VR-B193M	10
AER1507	VR-B197	12	1161178	VR-B199-3	12	21221348	VR-B197	12
AER1508	VR-IK019	76	1162829	VR-B199-4	13	21221349	VR-B195M	11
AER1510	VR-IK019	76	1171370	VR-B198	12	21221373	VR-B193M	10
AER1511	VR-IK029	76	1173068	VR-B193M	10	21221411	VR-B193M	10
AER1519	VR-B194	10	1173069	VR-B202	13	21221412	VR-B196M	11
AER1520	VR-B198	12	1173069	VR-B202L	14	21221416	VR-B196M	11
AER1521	VR-PR1000H	124	1177145	VR-B202L	14	21222081	VR-F114A	82
AER1527	VR-B193M	10	1177145	VR-B202	13	21222106	VR-F114A	82
AER1528	VR-IK149	76	1177496	VR-B193M	10	21222119	VR-F114B	82
AER1543	VR-IK149	76	1178336	VR-B203	14	21222126	VR-F119B	83
AER1603	VR-IK15	76	1178644	VR-B202	13	21222127	VR-F119	82
AER2901	VR-B191	9	1178644	VR-B202L	14	21225183	VR-PR2000H	127
AER2901	VR-B190	8	1306480	VR-B197	12	21225345	VR-PR1000H	124
AER2902	VR-B190	8	1306557	VR-B193M	10	21225372	VR-PR135B	125
AER2902	VR-B191	9	1308784	VR-B194	10	21225372	VR-PR135BA	125
AER3001	VR-F110B	82	1318548	VR-B195M	11	21225423	VR-PR123	124
AER3003	VR-B191	9	1320082	VR-B206	14	21226041	VR-D670C	33
AER3003	VR-B190	8	1320381	VR-B206	14	21226042	VR-D668C	33
AER3006	VR-DU510	120	1320407	VR-B193M	10	21229047	VR-VW002	122
AER3007	VR-F110A	82	2404414	VR-B199-3	12	21229048	VR-VW003	122
AER7201	VR-B193M	10	2404417	VR-B199-4	13	21229114	VR-VW002	122
AER7207	VR-B193M	10	4701484	VR-B197	12	21229142	VR-VW003	122
NRE121301	VR-B193M	10	8121111	VR-B195M	11	21229167	VR-LD150A	79
ISUZU			8122110	VR-B199-4	13	21229189	VR-LD160	79
1-81251-004-0	VR-H2003-1B	110	8122152	VR-B198	12	21229199	VR-VW005N	122
1-81251-024-0	VR-H2003-1B	110	8122153	VR-B193M	10	21229491	VR-VW002	122
5-81251-012-0	VR-H2003-1B	110	8122154	VR-B197	12	2131049	VR-VW010	123
5-81251-016-0	VR-H2000-2B	67	8122275	VR-B206	14	21511095	VR-H2009-3	100
5-81270-004-0	VR-H2000-2	66	B25N92117J	VR-B199-3	12	21511109	VR-H2000-12	64
8-9413-053-0	VR-H2005-4A	53	N92117T1	VR-B199-3	12	21511113	VR-H2000-1	64
8-94139-012-0	VR-H2005-5H	54	S1H7615	VR-B199-3	12	21511113	VR-H2000-32	68
8-94156590-0	VR-H2000-29BC	67	S4H7615	VR-B199-4	13	21511116	VR-H2009-3	100
8-94156590-0	VR-H2000-29BA-2	67	T1H7615	VR-B191	9	21513103	VR-H2009	87
8-94156590-0	VR-H2000-29B	67	T1H7615	VR-B190	8	21513125	VR-H2009-6H	105
8-94156-595-0	VR-H2000-3A	69	T4H7615	VR-B190	8	21513126	VR-H2009-8H	107
8-94167-410-0	VR-H2000-29	66	T4H7615	VR-B191	9	21513133	VR-H2009-9H	109
8-94167-410-0	VR-H2000-29A-2	67	KOMATSU			21930021	VR-DU510	120
8-94167-410-0	VR-H2000-29C	67	21J17	VR-H2001-3	63	21930022	VR-DU509	120
8-94237-720-0	VR-H2000-3	67	KUBOTA			2193008	VR-F110B	82
8-94239-079-0	VR-H2005-29	50	19260-64011	VR-H2005-59	54	21931004	VR-B191	9
8-94249-860-0	VR-H2000-12	64	19260-64012	VR-H2005-59	54	21931004	VR-B190	8
8-94250-964-0	VR-H2000-3	67	19279-64010	VR-H2005-59	54	21931006	VR-DU510	120
8-94250-968-0	VR-H2000-3	67	19279-64011	VR-H2005-59	54	21931009	VR-B193M	10
8-94455-160	VR-H2005-24	50	19279-64012	VR-H2005-59	54	21931011	VR-B198	12
8-94455160-0	VR-H2005-26A	50	LADA			21931013	VR-B190	8
8-94462-849-0	VR-H2000-9	73	173701010	VR-LD150A	79	21931013	VR-B191	9
8-97032-091-0	VR-H2005-16A	45	173702	VR-LD160	79	21931015	VR-B199-4	13
8-97122796-0	VR-H2005-77	56	21013702000	VR-F110A	82	21931016	VR-B199-3	12
8-971860551-1	VR-H2000-94B	74	21033701500	VR-LD150A	79	21932004	VR-F114A	82
IVECO			21053701500	VR-LD150A	79	2193818A	VR-LC112	80
42532975	VR-B543B	24	21083701010	VR-IK149	76	230283	VR-LC111	80
79078923	VR-B198	12	21083701500	VR-LD160	79	26214105	VR-LC110	80
93157259	VR-B206	14	224370701	VR-IK149	76	26215045	VR-LC106	80
9988935	VR-B197	12	56-7-625/5	VR-LD160	79	26938063A	VR-LC108	80
JDWP			EP1	VR-LD160	79	26938068B	VR-LC107	80
JFZ1913	VR-H2009-117	89	T2223701010	VR-IK149	76	26938161A	VR-LC112	80
JOHN DEERE			LAMBORGHINI			28000010	VR-LC111	80
AL30420	VR-B194	10	294295100	VR-B193M	10	28001010	VR-LC111	80
AL35999	VR-B194	10	29429600	VR-B191	9	28002	VR-LC111B	80
AL36101	VR-B193M	10	29429600	VR-B190	8	35381720	VR-LC115	81
AL65077	VR-B194	10	294390903	VR-B193M	10	37175	VR-DU510	120
AM102596	VR-JD357	77	296195100	VR-B193M	10	37534	VR-LC100	80
AM106357	VR-JD357	77	LANCIA			37538	VR-LC100	80
AM123296	VR-JD357	77	82243312	VR-B199-3	12	37541	VR-LC100	80
AM34738	VR-JD357	77	82294110	VR-B199-3	12	37555	VR-LC100	80
AT31413	VR-B191	9	82301179	VR-B199-4	13	37558	VR-LC100	80
AT31413	VR-B190	8	LIEBHERR			37561	VR-LC100	80
AZ24490	VR-B193M	10	5004185	VR-B198	12	37565	VR-LC100	80
KIA			5603582	VR-B198	12	37566	VR-LC100	80
OK201-18-300B	VR-H2009-116	78	6000094	VR-B199-3	12	37581	VR-LC100	80
OK201-18-W70A	VR-H2009-116	78	6201558	VR-B199-4	13	37587	VR-LC100	80
OK24A-18-300A	VR-H2009-116	78	6912701	VR-B199-4	13	37612	VR-LC100	80
OK29T-18-300	VR-H2009-116	78	6912707	VR-B199-3	12	37621	VR-LC201	81
OK2A2-18-W63	VR-MD07	86	6930211	VR-B191	9	37624	VR-LC200	81
37370-22200	VR-H2009-86	86	6930211	VR-B190	8	37628	VR-LC100	80
37370-27011	VR-K05	78	LUCAS			37636	VR-LC200	81

**CROSS REFERENCE
Voltage Regulator**

OEM No. → Mobiletron No.

OEM No.	Part No.	Page	OEM No.	Part No.	Page	OEM No.	Part No.	Page
37639	VR-LC100	80	UCB153	VR-LC113L	81	64800001	VR-B190	8
37640	VR-LC200	81	UCB155	VR-LC111B	80	64800002	VR-DU510	120
37647	VR-LC100	80	UCB206	VR-DU511	120	64800004	VR-B199-3	12
37653	VR-LC100	80	UCB207	VR-DU511	120	64800005	VR-B199-4	13
37657	VR-LC100	80	UCB218	VR-PR1000H	124	64800007	VR-B197	12
37659	VR-LC200	81	UCB220	VR-PR2000H	127	64808010	VR-B192	9
37659	VR-LC201	81	UCB223	VR-PR1000H	124	64808011	VR-B192	9
37661	VR-LC200	81	UCB227	VR-DU512	120	64808012	VR-B193M	10
37666	VR-LC200	81	UCB235	VR-DU513	121	64808020	VR-F110A	82
37667	VR-LC200	81	UCB237	VR-PR128B	125	64808100	VR-B192	9
37672	VR-LC100	80	UCB239	VR-PR135BA	125	64808101	VR-F110A	82
37679	VR-LC100	80	UCB239	VR-PR135B	125	64808102	VR-F110B	82
37683	VR-LC100	80	UCB243	VR-PR135	125	64808103	VR-F110A	82
37684	VR-LC200	81	UCB245	VR-VW010	123	64808106	VR-F114A	82
37684	VR-LC201	81	UCB400	VR-B193M	10	64808108	VR-F110B	82
37686	VR-LC200	81	UCB402	VR-B197	12	64808109	VR-B193M	10
37690	VR-LC200	81	UCB403	VR-B195M	11	64808140	VR-F114A	82
37695	VR-DU510	120	UCB404	VR-B198	12	64808141	VR-F114B	82
37696	VR-DU509	120	UCB407	VR-B220	15	64808143	VR-F114A	82
37697	VR-B191	9	UCB412	VR-H2005-4A	53	64808182	VR-F118	82
37697	VR-B190	8	UCB412	VR-B193M	10	64808184	VR-F118	82
37701	VR-LC111	80	UCB413	VR-B196M	11	64808241	VR-F118	82
37703	VR-LC111	80	UCB500	VR-VW002	122	64808243	VR-F118	82
37705	VR-LC111	80	UCB501	VR-VW003	122	79707161	VR-F119	82
37707	VR-LC111	80	UCB506	VR-VW005N	122	79707441	VR-F119B	83
37707A	VR-LC111	80	UCB700	VR-D670C	33	79707481	VR-F119	82
37709	VR-LC200	81	UCB701	VR-D668C	33	81200270	VR-F114B	82
37735	VR-LC113L	81	UCB702	VR-D671C	33	83600151	VR-F119	82
54022415	VR-LC111B	80	UCB703	VR-D673C	33	83607041	VR-F118	82
54048473	VR-LC111	80	UCB704	VR-D676	34	83607111	VR-F118	82
54048600	VR-LC111	80	UCB705	VR-D674H	34	83611361	VR-F151A	83
54205986	VR-LC111	80	UCB705	VR-D674	33	83614251	VR-F121T	83
54206177	VR-LC111	80	UCB802	VR-F114A	82	83615921	VR-F150A	83
54206448	VR-LC111	80	UCB805	VR-F114A	82	83617181	VR-F153A	83
54206467	VR-LC111	80	UCB806	VR-F119B	83	83627781	VR-F156	84
54206645	VR-LC111	80	UCB807	VR-F114B	82	85552506	VR-F159	84
54206688	VR-LC111	80	UCB808	VR-F119	82	85561291	VR-F151A	83
54207336	VR-LC111	80	UCB900	VR-LD150A	79	85562061	VR-F155	83
54208417	VR-LC111	80	UCB902	VR-LD160	79	85562541	VR-F156	84
581200220000	VR-F119	82	UCJ126	VR-H2000-12	64	85562541	VR-F156	84
581200220100	VR-F119	82	UCJ200	VR-H2009	87	85562731	VR-F158	84
66201555	VR-LC111	80	UCJ207	VR-H2009-3	100	85562801	VR-F156	84
83627781010	VR-F156	84	UCJ233	VR-H2009-8H	107	85562801	VR-F156	84
84959	VR-LC111B	80	UCJ235	VR-H2009-6H	105	85562881	VR-F158	84
85562541010	VR-F156	84	UCJ423	VR-H2005-23A	50	85562991	VR-F158	84
GA15	VR-LC110	80	MAGIRUS-DEUTZ			85563051	VR-F151A	83
NCB201	VR-DU510	120	1160363	VR-B191	9	85563051010	VR-F151A	83
NCB203	VR-DU509	120	1160363	VR-B190	8	85563481	VR-F160	84
NCB205	VR-B191	9	1160376	VR-B190	8	85563491	VR-F157	84
NCB205	VR-B190	8	1160376	VR-B191	9	85563501	VR-F155	83
NCB209	VR-DU510	120	1162829	VR-B199-4	13	8556351010	VR-F151A	83
NCB211	VR-DU510	120	42484638	VR-B192	9	85582601	VR-F156	84
NCB212	VR-DU509	120	4701484	VR-B197	12	940016012300	VR-F156	84
NCB218	VR-PR1000H	124	MAGNETI MARELLI			940038005	VR-B220	15
NCB403	VR-B191	9	000083611361	VR-F151A	83	940038030	VR-D701	36
NCB403	VR-B190	8	000085561291	VR-F151A	83	940038032	VR-D673C	33
NCB406	VR-B199-4	13	058120056010	VR-F151A	83	940038033	VR-D671C	33
NCB407	VR-B199-3	12	083611361010	VR-F151A	83	940038047	VR-DU512	120
NCB811	VR-F110B	82	083613011010	VR-F151A	83	940038067	VR-H2000-47	70
SR30	VR-LC106	80	085582601010	VR-F156	84	940038067	VR-H2000-47C	70
SR40	VR-LC108	80	24TR	VR-F121T	83	940038075	VR-H2009-3	100
SR60	VR-LC112	80	24TR/B	VR-F121T	83	940038076	VR-H2009	87
TR15	VR-LC107	80	28000	VR-LC111	80	940038078	VR-H2000-1	64
UCB100	VR-LC100	80	28000010	VR-LC111	80	940038078	VR-H2000-32	68
UCB100X	VR-LC100	80	28001	VR-LC111	80	940038084	VR-H2009-7H	106
UCB114	VR-LC100	80	28018A	VR-F121	83	940038085	VR-H2009-4H	102
UCB124X	VR-LC200	81	331850	VR-F151A	83	940038086	VR-H2009-9H	109
UCB126	VR-LC200	81	501200530000	VR-F151A	83	940038087	VR-H2005-23A	50
UCB126	VR-LC201	81	501200530010	VR-F151A	83	940038088	VR-H2009-6H	105
UCB129	VR-LC200	81	54209276	VR-F154	83	940038089	VR-H2000-1	64
UCB129X	VR-LC200	81	54209305	VR-F121T	83	940038089	VR-H2000-32	68
UCB133	VR-LC200	81	58120022	VR-F119	82	940038097	VR-H2005-40	53
UCB133X	VR-LC200	81	5812002200	VR-F119	82	940038112	VR-LD150A	79
UCB134	VR-LC200	81	58120053	VR-F151A	83	940038132	VR-LC200	81
UCB134X	VR-LC200	81	581200530000	VR-F151A	83	940038151	VR-VW005N	122
UCB137	VR-LC200	81	581200530010	VR-F151A	83	940038161	VR-PR2000H	127
UCB139	VR-LC200	81	63400006	VR-B191	9	940038162	VR-PR1000H	124
UCB142	VR-LC200	81	63400006	VR-B190	8	940038173	VR-PR3729A	129
UCB148	VR-LC111	80	63408004	VR-F110A	82	940038186	VR-VW010	123
UCB148X	VR-LC111	80	63408005	VR-F110A	82	943241001	VR-H2005-7A	56
UCB150	VR-LC111	80	63408007	VR-F110A	82	943356220	VR-VW010	123
UCB150X	VR-LC111	80	63408305	VR-F110B	82	943356220010	VR-VW010	123
UCB151	VR-LC111	80	63408306	VR-F110B	82	MSR1001	VR-H2005-7A	56
UCB151X	VR-LC111	80	63472000	VR-F110A	82	RTM121A	VR-F151A	83
UCB152	VR-LC111	80	64800001	VR-B191	9	RTM150B	VR-F150A	83

**CROSS REFERENCE
Voltage Regulator**

OEM No. → Mobiletron No.

OEM No.	Part No.	Page	OEM No.	Part No.	Page	OEM No.	Part No.	Page
RTM151A	VR-F151A	83	12449	VR-MD03	86	0031545606	VR-B363	22
RTM151B	VR-F151A	83	37300-42010	VR-MD01	86	0031545706	VR-B883	27
RTM151C	VR-F151A	83	37300-42502	VR-MD01	86	0031545906	VR-B132	7
RTM152A	VR-F151A	83	37300-42750	VR-MD01	86	0031546106	VR-B885	27
RTM153B	VR-F153A	83	37300-45001	VR-MD14B	75	0031547106	VR-B132	7
RTM200.03	VR-F160	84	3ER1071	VR-MD04	86	003-154-72-06	VR-B150	7
RTM200.09	VR-F160	84	42785	VR-MD04	86	0031549106	VR-B363	22
RTM24TR	VR-F121T	83	42786	VR-MD03	86	003-154-96-06	VR-B150	7
RTM300.01	VR-F157	84	809163	VR-H2009-75	106	0041540306	VR-B132	7
RTT110A	VR-B192	9	811883	VR-H2009-75	106	11545106	VR-B190	8
RTT110AB	VR-B192	9	A500C0111	VR-H2009-75	106	11545106	VR-B191	9
RTT110ABT	VR-B192	9	AB170036	VR-H2009-116	78	11546806	VR-B191	9
RTT110B	VR-F110A	82	AB170066	VR-H2009-116	78	11546806	VR-B190	8
RTT110BBJ	VR-F110A	82	AB180092	VR-H2009-116	78	11546906	VR-B190	8
RTT110BJ	VR-F110A	82	TA000A29102	VR-H2009-89	86	11546906	VR-B191	9
RTT110C	VR-F110B	82	TA500C02001A	VR-H2009-116	78	11547006	VR-B199-3	12
RTT110CCJ	VR-F110B	82	TA500C02701	VR-H2009-116	78	11548106	VR-B199-3	12
RTT110J	VR-F110B	82	TA500-C09001	VR-MD06	86	11548406	VR-B191	9
RTT114A	VR-F114A	82	MASSEY FERGUSON			11548406	VR-B190	8
RTT114B	VR-F114B	82	1718347M1	VR-B191	9	11548506	VR-B190	8
RTT118C	VR-F118	82	1718347M1	VR-B190	8	11548506	VR-B191	9
RTT118E	VR-F118	82	1865974M1	VR-LC111	80	11548806	VR-B199-4	13
RTT118J	VR-F118	82	1887416M1	VR-LC100	80	11549106	VR-B199-3	12
RTT119A	VR-F119	82	1897266M1	VR-LC200	81	1500255	VR-VW009	123
RTT119AAC	VR-F119	82	1897294M1	VR-LC200	81	1541705	VR-B203	14
RTT119AC	VR-F119	82	1897383M1	VR-LC100	80	1541805	VR-B202	13
RTT119B	VR-F119B	83	1897699M91	VR-LC111	80	1541805	VR-B202L	14
MAGNETON-PAL			2868511M91	VR-B199-4	13	1542405	VR-B396	24
134291	VR-MP134	85	2945680M1	VR-B199-3	12	1542406	VR-B396	24
134541	VR-MP134	85	3188023M1	VR-B193M	10	1542605	VR-B396	24
136110	VR-MP134	85	345773M91	VR-LC111	80	1542705	VR-B396	24
136111	VR-MP134	85	3473155M1	VR-LC200	81	1548506	VR-B191	9
136131	VR-MP134	85	3473593M1	VR-LC200	81	1548506	VR-B190	8
143411	VR-MP134	85	3474604M91	VR-LC111	80	21540206	VR-B199-4	13
143431	VR-MP134	85	3476714M91	VR-LC111	80	21540506	VR-B199-3	12
443116419070	VR-MP419	85	MAZDA			21540606	VR-B192	9
443116419071	VR-MP419	85	8173-18-300	VR-H2009	87	21541506	VR-B191	9
443930134291	VR-MP134	85	8173-24-520	VR-H2009	87	21541506	VR-B190	8
443930134540	VR-MP134	85	8574-24-520	VR-H2009-3	100	21541806	VR-B192	9
443930134541	VR-MP134	85	8599-24-520	VR-H2009-53	103	21542506	VR-B192	9
443930135641	VR-MP134	85	B307-18-W70	VR-H2009-129	91	21542806	VR-B191	9
443930136110	VR-MP134	85	B3C7-18-W70	VR-H2009-129	91	21542806	VR-B190	8
443930136111	VR-MP134	85	B64J-18-W70	VR-H2009-22	99	21543006	VR-B190	8
443930136131	VR-MP134	85	B675-18-70A	VR-H2009-7H	106	21543006	VR-B191	9
MAN			B675-18-W70	VR-H2009-7H	106	21543206	VR-B193M	10
30535010001	VR-B199-3	12	BF1462	VR-H2009-9H	109	21543506	VR-B206	14
51256017029	VR-B199-3	12	E356-18-W70	VR-H2009-4H	102	21543606	VR-B191	9
51256017036	VR-B199-3	12	E356-18-W70	VR-H2009-4A	102	21543606	VR-B190	8
51256017037	VR-B191	9	E358-18-W70	VR-H2009-4A	102	21543706	VR-B202	13
51256017037	VR-B190	8	F285-18-W70	VR-H2009-26	99	21543706	VR-B202L	14
51256017041	VR-B199-3	12	FE65-24-520	VR-H2009-4H	102	21543806	VR-B198	12
51256017046	VR-B199-3	12	FE65-24-520	VR-H2009-4A	102	21543906	VR-B198	12
81256010002	VR-B190	8	FE79-24-520	VR-H2009-4A	102	21544006	VR-B194	10
81256010002	VR-B191	9	FE79-24-520	VR-H2009-4H	102	21544106	VR-B196M	11
81256010003	VR-B191	9	FE85-18-W70	VR-H2009-9H	109	21544706	VR-B198	12
81256010003	VR-B190	8	GY01-18-W70	VR-H2009-100	87	21544906	VR-B198	12
81256010004	VR-B190	8	JE15-18-W70A	VR-H2009-33	100	21545106	VR-B196M	11
81256010004	VR-B191	9	JE48-18-W70	VR-H2009-22	99	21545506	VR-B206	14
81256010005	VR-B191	9	JE48-18-W70	VR-H2009-129	91	21545806	VR-B192	9
81256010005	VR-B190	8	N221-24-520	VR-H2009	87	21546406	VR-B198	12
81256010008	VR-B199-3	12	RF01-24-520	VR-H2000-3	67	21546706	VR-B198	12
81256010010	VR-B199-4	13	RGF1-18-W70	VR-H2009-67	104	21546806	VR-B206	14
81256010011	VR-B199-4	13	S208-24-520	VR-H2000-3	67	21547206	VR-B196M	11
81256010014	VR-B199-3	12	SE17-24-520	VR-H2009-19	97	21547406	VR-B191	9
81256010021	VR-B191	9	SE21-24-520	VR-H2009-18	96	21547406	VR-B190	8
81256010021	VR-B190	8	SLA1-18-W70	VR-H2009-193B	97	21547606	VR-B198	12
81256010025	VR-B558B	24	Y406-18-300	VR-V4291	116	21547902	VR-B196MH	11
81256016007	VR-B199-3	12	MELROE			21547906	VR-B196MH	11
81256016013	VR-B197	12	6659393	VR-H2009-75	106	21548406	VR-B209	14
81256016014	VR-B198	12	MERCEDES-BENZ			21548406	VR-B203	14
81256016015	VR-B206	14	0021548106	VR-B201H	13	21548502	VR-B200H	13
81256016016	VR-B198	12	0021548206	VR-B201H	13	21549106	VR-VW010	123
81256016017	VR-B197	12	0021548506	VR-B201H	13	31546006	VR-B414	24
81256016020	VR-B193M	10	0021548706	VR-B201H	13	31547206	VR-B150	7
81256016021	VR-B206	14	0021549206	VR-B201H	13	31549606	VR-B150	7
81256016023	VR-B198	12	0022159106	VR-B201H	13	3505477102	VR-B199-4	13
81256016024	VR-B198	12	003 154 72 06	VR-B150	7	A 003 154 72 06	VR-B150	7
81256016025	VR-B206	14	003 154 96 06	VR-B150	7	A 003 154 96 06	VR-B150	7
81256016027	VR-B198	12	0031540606	VR-B201H	13	A0001501750	VR-D745	38
81256016030	VR-B206	14	0031541506	VR-B252	17	A0031544106	VR-B132	7
81256016031	VR-B198	12	0031542806	VR-B264	19	A0031545906	VR-B132	7
90801101270	VR-B191	9	0031542906	VR-B363	22	A0031547106	VR-B132	7
90801101270	VR-B190	8	0031544106	VR-B132	7	A0041540306	VR-B132	7
90801101322	VR-B199-4	13	0031545506	VR-B264	19	MITSUBISHI		
MANDO			0031545606	VR-B264	19	145	VR-H2009-103	87

CROSS REFERENCE
Voltage Regulator

CROSS REFERENCE
Rectifier

CROSS REFERENCE
Diode Trio

ALTERNATOR NO.
Reg & Rec

**CROSS REFERENCE
Voltage Regulator**

OEM No. → Mobiletron No.

OEM No.	Part No.	Page	OEM No.	Part No.	Page	OEM No.	Part No.	Page
234309	VR-H2009-85	107	A3TX0692	VR-H2009-140	92	A866X12770	VR-H2009-7H	106
255	VR-H2009-67	104	A860X25472	VR-H2009-38	101	A866X12772	VR-H2009-7H	106
263	VR-H2009-59	103	A866T00470	VR-H2009	87	A866X12780	VR-H2009-7H	106
275	VR-H2009-79	106	A866T00670	VR-H2009	87	A866X12782	VR-H2009-7H	106
283	VR-H2009-80B	107	A866T00870	VR-H2009-3	100	A866X12980	VR-H2009-7H	106
285	VR-H2009-73	106	A866T01070	VR-H2009-17	94	A866X13272	VR-H2009-15	93
300	VR-H2009-141	92	A866T01871	VR-H2009-51	103	A866X13571	VR-H2009-92	108
3177203J	VR-H2009-71	105	A866T01970	VR-H2009	87	A866X13670	VR-H2009-20	98
328	VR-H2009-207B	98	A866T02070	VR-H2009-21	98	A866X13970	VR-H2009-10A	88
341	VR-H2009-115	89	A866T02570	VR-H2009	87	A866X13971	VR-H2009-10A	88
349	VR-H2009-80	107	A866T02770	VR-H2009	87	A866X14072	VR-H2009-11H	90
350	VR-H2009-115	89	A866T02970	VR-H2009-3	100	A866X14570	VR-H2009-103	87
358	VR-H2009-83	107	A866T03070	VR-H2009-18	96	A866X14570	VR-H2009-26	99
359	VR-H2009-111	89	A866T03270	VR-H2009	87	A866X14572	VR-H2009-26	99
362	VR-H2009-85	107	A866T03470	VR-H2009-18	96	A866X14572	VR-H2009-103	87
385	VR-H2009-67	104	A866T03570	VR-H2009-19	97	A866X15170	VR-H2009-15	93
391	VR-H2009-120	90	A866T03870	VR-H2009-16	94	A866X15472	VR-H2009-25	99
3Y6693	VR-H2009-1	87	A866T05270	VR-H2009-6H	105	A866X15770	VR-H2009-34	100
403	VR-H2009-82	107	A866T05272	VR-H2009-4A	102	A866X17072	VR-H2009-33	100
428	VR-H2009-159	93	A866T05670	VR-H2009-16	94	A866X17170	VR-H2009-24	99
429	VR-H2009-118	90	A866T06570	VR-H2009-48	102	A866X17172	VR-H2009-24	99
435	VR-H2009-115	89	A866T06670	VR-H2009-12	90	A866X17272	VR-H2009-65	104
438	VR-H2009-152	93	A866T06870	VR-H2009-47	102	A866X17470	VR-H2009-15	93
444	VR-H2009-100	87	A866T08570	VR-H2009-46	102	A866X17872	VR-H2009-193B	97
458	VR-H2009-85	107	A866T09170	VR-H2009-28	100	A866X17972	VR-H2009-26	99
465	VR-H2009-100	87	A866T09780	VR-H2009-78	106	A866X17972	VR-H2009-26	99
475	VR-H2009-95	108	A866T09782	VR-H2009-78	106	A866X17982	VR-H2009-26	99
476	VR-H2009-99	109	A866T13370	VR-H2009-16	94	A866X18972	VR-H2009-35	100
487	VR-H2009-94	108	A866T17972	VR-H2009-26	99	A866X19072	VR-H2009-41	101
491	VR-H2009-112	89	A866T18270	VR-H2009-18	96	A866X19172	VR-H2009-15	93
497	VR-H2009-205B	98	A866T29570	VR-H2009-88	107	A866X19972	VR-H2009-69B	105
498	VR-H2009-105	88	A866T30070	VR-H2009-141	92	A866X20472	VR-H2009-22	99
499	VR-H2009-85	107	A866T38570	VR-H2009-20	98	A866X20572	VR-H2009-129	91
503	VR-H2009-102	87	A866T52970	VR-H2009-98	109	A866X20782	VR-H2009-15	93
504	VR-H2009-71	105	A866X00179	VR-H2009-26	99	A866X20972	VR-H2009-22	99
505	VR-H2009-114	89	A866X01070	VR-H2009-17	94	A866X21072	VR-H2009-33	100
506	VR-H2009-105SE	88	A866X01670	VR-H2009-54	103	A866X21472	VR-H2009-15	93
513	VR-H2009-144	92	A866X01871	VR-H2009-51	103	A866X21472	VR-H2009-15	93
514	VR-H2009-154B	93	A866X02170	VR-H2009-53	103	A866X21482	VR-H2009-15	93
517	VR-H2009-93	108	A866X04870	VR-H2009-4A	102	A866X22072	VR-H2009-20	98
518	VR-H2009-153	93	A866X04871	VR-H2009-4A	102	A866X22081	VR-H2009-40	101
529	VR-H2009-98	109	A866X04871	VR-H2009-4H	102	A866X22272	VR-H2009-38	101
530	VR-H2009-196	97	A866X04872	VR-H2009-4H	102	A866X22472	VR-H2009-45	101
533	VR-H2009-168	94	A866X04872	VR-H2009-4A	102	A866X22772	VR-H2009-22	99
542	VR-H2009-175	95	A866X05270	VR-H2009-6H	105	A866X23072	VR-H2009-45	101
544	VR-H2009-145	92	A866X05272	VR-H2009-6H	105	A866X23172	VR-H2009-37	101
547	VR-H2009-145	92	A866X05470	VR-H2009-4H	102	A866X23200	VR-H2009-49	102
547	VR-H2009-130	91	A866X05470	VR-H2009-4A	102	A866X23772	VR-H2009-44	101
548	VR-H2009-147	92	A866X05471	VR-H2009-4A	102	A866X23972	VR-H2009-69	104
551	VR-H2009-164	94	A866X05471	VR-H2009-4H	102	A866X24072	VR-H2009-129	91
553	VR-H2009-132BA	91	A866X05472	VR-H2009-4H	102	A866X24082	VR-H2009-129	91
553	VR-H2009-132B	91	A866X05472	VR-H2009-4A	102	A866X24272	VR-H2009-43	101
555	VR-H2009-197B	97	A866X05870	VR-H2009-56	103	A866X24472	VR-H2009-67	104
557	VR-H2009-159	93	A866X06072	VR-H2009-4H	102	A866X24572	VR-H2009-64	104
558	VR-H2009-113	89	A866X06072	VR-H2009-4A	102	A866X24972	VR-H2009-67	104
561	VR-H2009-126	91	A866X06470	VR-H2009-27	100	A866X24972	VR-H2009-67	104
564	VR-H2009-148	93	A866X06471	VR-H2009-27	100	A866X25372	VR-H2009-129	91
565	VR-H2009-183B	96	A866X07570	VR-H2009-9H	109	A866X25572	VR-H2009-67	104
566	VR-H2009-122	90	A866X07572	VR-H2009-9H	109	A866X25872	VR-H2009-57	103
5689202	VR-H2009-177	95	A866X08070	VR-H2009-8H	107	A866X26070	VR-H2009-77B	106
5689202N	VR-H2009-177	95	A866X08071	VR-H2009-8H	107	A866X26072	VR-H2009-77B	106
574	VR-H2009-160	94	A866X08072	VR-H2009-8H	107	A866X26172	VR-H2009-63	104
576	VR-H2009-125B	91	A866X08270	VR-H2009-32	100	A866X26641	VR-H2009-50	103
590	VR-H2009-110	89	A866X08271	VR-H2009-32	100	A866X27472	VR-H2009-129	91
594	VR-H2009-180	96	A866X08472	VR-H2009-23	99	A866X27572	VR-H2009-79	106
598	VR-H2009-172	95	A866X08672	VR-H2009-4A	102	A866X27772	VR-H2009-22	99
605	VR-H2009-139	92	A866X08672	VR-H2009-4A	102	A866X28372	VR-H2009-80B	107
606	VR-H2009-170	94	A866X08871	VR-H2009-69B	105	A866X28572	VR-H2009-73	106
610	VR-H2009-183B	96	A866X08971	VR-H2009-69	104	A866X28672	VR-H2009-161	94
622	VR-H2009-140	92	A866X09071	VR-H2009-6H	105	A866X29272	VR-H2009-7H	106
623	VR-H2009-194	97	A866X09170	VR-H2009-28	100	A866X29582	VR-H2009-88	107
626	VR-H2009-115	89	A866X09171	VR-H2009-28	100	A866X31882	VR-H2009-62	104
628	VR-H2009-199	97	A866X09270	VR-H2009-185	96	A866X32672	VR-H2009-201	98
630	VR-H2009-189	96	A866X09271	VR-H2009-185	96	A866X34172	VR-H2009-70A	105
654	VR-H2009-176	95	A866X09771	VR-H2009-6H	105	A866X34272	VR-H2009-115	89
660	VR-H2009-173	95	A866X09782	VR-H2009-6H	105	A866X34572	VR-H2009-95	108
661	VR-H2009-173	95	A866X09971	VR-H2009-26	99	A866X34997	VR-H2009-80	107
667	VR-H2009-171	95	A866X09972	VR-H2009-26	99	A866X35072	VR-H2009-115	89
675	VR-H2009-183B	96	A866X09982	VR-H2009-26	99	A866X35472	VR-H2009-95	108
682	VR-H2009-130	91	A866X10271	VR-H2009-28	100	A866X35872	VR-H2009-83	107
686	VR-H2009-180	96	A866X11682	VR-H2009-4A	102	A866X35972	VR-H2009-111	89
695	VR-H2009-198	97	A866X11772	VR-H2009-41	101	A866X36272	VR-H2009-118	90
700	VR-H2009-208	98	A866X11870	VR-H2009-14N	93	A866X37272	VR-H2009-99	109
992	VR-H2009-201	98	A866X12472	VR-H2009-6H	105	A866X38072	VR-H2009-129	91
A3TB1891	VR-H2009-109	88	A866X12682	VR-H2009-30	100	A866X38472	VR-H2009-67	104

**CROSS REFERENCE
Voltage Regulator**

**CROSS REFERENCE
Rectifier**

**CROSS REFERENCE
Diode Trio**

**ALTERNATOR NO.
Reg & Rec**

**CROSS REFERENCE
Voltage Regulator**

OEM No. → Mobiletron No.

OEM No.	Part No.	Page	OEM No.	Part No.	Page	OEM No.	Part No.	Page
A866X38672	VR-H2009-96B	108	GR801	VR-F786M	60	23215-B9800	VR-H2000-32	68
A866X39172	VR-H2009-120	90	GR801	VR-F786BH	59	23215-C6800	VR-H2000-29BA-2	67
A866X39183	VR-H2009-120	90	GR811	VR-F811	60	23215-C6800	VR-H2000-29BC	67
A866X39772	VR-H2009-38	101	GR814	VR-F814	60	23215-C6800	VR-H2000-29B	67
A866X40371	VR-H2009-82	107	GR815	VR-F815	60	23215-C6800	VR-H2000-3A	69
A866X41072	VR-H2009-203	98	GR818	VR-F818	61	23215-F2500	VR-H2000-1	64
A866X41272	VR-H2009-80B	107	GR819	VR-F818	61	23215-F2500	VR-H2000-1H	65
A866X42972	VR-H2009-118	90	GRE317	VR-H2009-11H	90	23215-F2500	VR-H2000-1L	65
A866X44472	VR-H2009-110	89	GRE797	VR-H2009-25	99	23215-F2500	VR-H2000-32	68
A866X45072	VR-H2009-97	108	GRE799	VR-H2009-26	99	23215-P0410	VR-H2009-4H	102
A866X46572	VR-H2009-100	87	GRE800	VR-H2009-9H	109	23215-P2500	VR-H2000-1L	65
A866X47172	VR-H2009-120	90	GRE802	VR-B391	23	23215-P2500	VR-H2000-1H	65
A866X47272	VR-H2009-109	88	NIKKO			23215-P2500	VR-H2000-1	64
A866X47672	VR-H2009-99	109	0-33719-0030	VR-H2003-2B	110	23215-P2500	VR-H2000-32	68
A866X48782	VR-H2009-94	108	0-33719-0031	VR-H2003-2B	110	23215-P3017	VR-H2009-3	100
A866X49872	VR-H2009-105	88	0-33719-0100	VR-H2003-2B	110	23215-Q4601	VR-H2000-32	68
A866X50372	VR-H2009-102	87	0-33719-0120	VR-H2003-2B	110	23215-Q4601	VR-H2000-1	64
A866X50572	VR-H2009-114	89	0-35719-0260	VR-H2000-76BA	72	23215-Q4601	VR-H2000-1H	65
A866X54472	VR-H2009-145	92	1-44000-0580	VR-H2003-1B	110	23215-Q4601	VR-H2000-1L	65
A866X54762	VR-H2009-130	91	1-44000-0730	VR-H2003-1B	110	23215-Q4602	VR-H2000-1L	65
A866X54779	VR-H2009-130	91	1-44000-0900	VR-H2003-2B	110	23215-Q4602	VR-H2000-1H	65
A866X55852	VR-H2009-113	89	1-44000-0900	VR-H2003-2B	110	23215-Q4602	VR-H2000-1	64
A866X56672	VR-H2009-122	90	7-44000-0900	VR-H2003-2B	110	23215-Q4602	VR-H2000-32	68
A866X68272	VR-H2009-130	91	7-44000-0901	VR-H2003-2B	110	23215-W1700	VR-H2000-3	67
F28518W70A	VR-H2009-26	99	7-44000-0903	VR-H2003-2B	110	23215-W1701	VR-H2000-3	67
MD619268	VR-H2009-70A	105	7-44000-0905	VR-H2003-2B	110	23215-W1710	VR-H2009-51	103
ME701399	VR-H2009-80B	107	7-44000-0906	VR-H2003-2B	110	23215-W7110	VR-H2009-3	100
MM502585	VR-H2009-64A	104	7-44000-0920	VR-H2003-2B	110	23313-08515	VR-H2009-27	100
R008T10471	VR-H2009-1	87	NISSAN			23500-99005	VR-H2001-3	63
R008T10472	VR-H2009-1	87	22020-85M10	VR-H2000-42	69	23500-99008	VR-H2000-2B	67
VR295	VR-H2009-88	107	22020-85M10	VR-H2000-38	68	23500-Z9003	VR-H2002-2	111
MITSUBISHI MOTORS			23100-2Y000	VR-H2000-46	70	23500-Z9007	VR-H2002-1	111
MD160671	VR-H2009-30	100	23125-04P10	VR-H2009-6H	105	23528-18G01	VR-H2000-30	68
MD607372	VR-H2009	87	23133-04P01	VR-H2000-6H	72	23528-29W00	VR-H2000-35	68
MD607500	VR-H2009-54	103	23133-08E15	VR-H2009-27	100	23528-V7200	VR-H2000-30	68
MD607570	VR-H2009	87	23133-13E00	VR-H2000-21	66	F285-18-W70A	VR-H2009-26	99
MD607619	VR-H2009-18	96	23133-16E05	VR-H2000-4H	70	OPEL		
MD611032	VR-H2009-4H	102	23133-26E60	VR-H2000-7H	72	1204226	VR-B191	9
MD611032	VR-H2009-4A	102	23133-58S00	VR-H2000-5H	71	1204226	VR-B190	8
MD611146	VR-H2009-4A	102	23133-58S01	VR-H2000-5H	71	1204229	VR-B190	8
MD611146	VR-H2009-4H	102	23133-77A00	VR-H2000-11	64	1204229	VR-B191	9
MD611432	VR-H2009-6H	105	23133-D0200	VR-H2000-37	68	1204230	VR-B191	9
MD611481	VR-H2009-28	100	23133-D4400	VR-H2000-5H	71	1204230	VR-B190	8
MD611502	VR-H2009-185	96	23133-F6100	VR-H2000-4H	70	1204231	VR-B190	8
MD611565	VR-H2009-6H	105	23133-F6500	VR-H2000-20	66	1204231	VR-B191	9
MD611588	VR-H2009-6H	105	23133-Q4601	VR-H2000-37	68	1204235	VR-B191	9
MD611668	VR-H2009-28	100	23133-Q9000	VR-LC111	80	1204235	VR-B190	8
MD611710	VR-H2009-6H	105	23133-W1606	VR-H2000-37	68	1204236	VR-D668C	33
MD611743	VR-H2009-41	101	23133-W7101	VR-H2000-37	68	1204239	VR-B190	8
MD618207	VR-H2009-4A	102	23215-04P10	VR-H2009-6H	105	1204239	VR-B191	9
MD618483	VR-H2009-6H	105	23215-05E16	VR-H2009-56	103	1204244	VR-B192	9
MD618569	VR-H2009-38	101	23215-0C001	VR-H2000-16	65	1204245	VR-D670C	33
MD618735	VR-H2009-67	104	23215-0L701	VR-H2000-46	70	1204246	VR-B193M	10
MD618845	VR-H2009-63	104	23215-0M011	VR-H2009-118	90	1204248	VR-D673C	33
MD618957	VR-H2009-73	106	23215-0M801	VR-H2000-38	68	1204252	VR-B193M	10
MD619167	VR-H2009-67	104	23215-0M810	VR-H2000-42	69	1204253	VR-B195M	11
MD619268	VR-H2009-70A	105	23215-0V000	VR-H2000-88	73	1204254	VR-B191	9
ME10997D	VR-H2009-71	105	23215-0W401	VR-H2000-38	68	1204254	VR-B190	8
ME700091	VR-H2009-17	94	23215-0W402	VR-H2000-43	69	1204256	VR-B195M	11
ME700556	VR-H2009-46	102	23215-17B10	VR-H2009-8H	107	1204257	VR-D674	33
ME700571	VR-H2009-12	90	23215-2J602	VR-H2000-88	73	1204257	VR-D674H	34
ME700635	VR-H2009-47	102	23215-2Y001	VR-H2000-46	70	1204258	VR-D674H	34
ME700783	VR-H2009-69B	105	23215-2Y005	VR-H2000-46	70	1204258	VR-D674	33
ME700799	VR-H2009-69	104	23215-31U05	VR-H2000-28	66	1204259	VR-B195M	11
ME701196	VR-H2009-69B	105	23215-35F10	VR-H2009-15	93	1204263	VR-D674	33
ME701260	VR-H2009-69	104	23215-50Y05	VR-H2000-14	64	1204263	VR-D674H	34
ME701302	VR-H2009-77B	106	23215-51S10	VR-H2009-8H	107	1204264	VR-D674H	34
ME701363	VR-H2009-79	106	23215-54A00	VR-H2000-3	67	1204264	VR-D674	33
ME701399	VR-H2009-80B	107	23215-58S10	VR-H2009-23	99	1204270	VR-D701	36
MM502532	VR-H2009-4A	102	23215-5V100	VR-H2000-42	69	1204288	VR-D711	37
MOTORCRAFT			23215-64J00	VR-H2000-18	65	1204289	VR-B252	17
EGR304	VR-LC100	80	23215-64J00	VR-H2000-17	65	1204434	VR-H2000-64	71
EGR311	VR-LC200	81	23215-64J01	VR-H2000-18	65	1204439	VR-B191	9
EGR313	VR-LC200	81	23215-64J02	VR-H2000-18	65	1204439	VR-B190	8
EGR314	VR-LC201	81	23215-64J11	VR-H2009-15	93	12793278	VR-B372	22
EGR351	VR-LC100	80	23215-64J12	VR-H2009-15	93	13117236	VR-H2000-64	71
GR307	VR-D668C	33	23215-64J13	VR-H2009-45	101	13153236	VR-H2000-64	71
GR504	VR-F540A	59	23215-70T00	VR-H2000-16	65	135546130	VR-H2000-64	71
GR533	VR-F540A	59	23215-72J00	VR-B200H	13	135546140	VR-H2000-64	71
GR534	VR-F540A	59	23215-77A10	VR-H2009-26	99	90007041	VR-B195M	11
GR536	VR-D669C	33	23215-85L00	VR-H2000-16	65	90349704	VR-B195M	11
GR540	VR-F540A	59	23215-97E01	VR-H2000-23	66	9117942	VR-B252	17
GR540A	VR-F540A	59	23215-B9800	VR-H2000-1L	65	9201135	VR-B252	17
GR801	VR-F786HC	59	23215-B9800	VR-H2000-1H	65	93176380	VR-B252	17
GR801	VR-F786H	59	23215-B9800	VR-H2000-1	64	93180104	VR-H2000-64	71

**CROSS REFERENCE
Voltage Regulator**

**CROSS REFERENCE
Rectifier**

**CROSS REFERENCE
Diode Trio**

**ALTERNATOR NO.
Reg & Rec**

**CROSS REFERENCE
Voltage Regulator**

OEM No. → Mobiletron No.

OEM No.	Part No.	Page	OEM No.	Part No.	Page	OEM No.	Part No.	Page
PERKINS			7701348281	VR-DU510	120	72260402	VR-DU510	120
28710252	VR-LC111	80	7701348589	VR-PR1000H	124	72260502	VR-DU510	120
PEUGEOT			ROVER			72260602	VR-DU510	120
5761.23	VR-DU510	120	BAU4919	VR-LC111	80	72317102	VR-B191	9
5761.24	VR-DU510	120	BAU5265	VR-LC111	80	72317102	VR-B190	8
5761.28	VR-DU509	120	BAU5958	VR-LC111	80	72415002	VR-DU510	120
5761.29	VR-DU509	120	FBU2243	VR-LC111	80	72415202	VR-DU510	120
5761.31	VR-DU509	120	FBV2243	VR-LC111	80	72415502	VR-DU510	120
5761.32	VR-DU510	120	RTC5044	VR-LC111	80	72415802	VR-DU510	120
5761.33	VR-DU510	120	RTC5370	VR-LC111	80	72416202	VR-DU510	120
5761.39	VR-VW002	122	RTC5670	VR-LC111	80	72416302	VR-DU510	120
5761.47	VR-B196M	11	RVI			72590602	VR-PR1000H	124
5761.48	VR-DU512	120	5430021883	VR-LC111	80	72590702	VR-PR1000H	124
5761.49	VR-DU512	120	SAAB			72590902	VR-PR2000H	127
5761.51	VR-PR127B	125	12759595	VR-H2000-64	71	72591202	VR-PR1000H	124
5761.55	VR-B196MH	11	7334634	VR-B190	8	72591502	VR-PR130	125
5761.56	VR-PR2000H	127	7334634	VR-B191	9	72610002	VR-DU510	120
5761.59	VR-B196M	11	8558306	VR-B193M	10	72610102	VR-DU510	120
5761.61	VR-DU512	120	8559577	VR-B193M	10	72610502	VR-DU510	120
5761.85	VR-B201H	13	8559585	VR-B194	10	72610602	VR-DU510	120
5761.86	VR-B201H	13	8559619	VR-B196M	11	72610702	VR-DU510	120
5761.87	VR-VW010	123	8571846	VR-B196M	11	72610902	VR-DU510	120
5761.9	VR-VW010	123	8581779	VR-B193M	10	72710002	VR-DU510	120
5835.02	VR-DU510	120	8590549	VR-B196MH	11	72710202	VR-DU510	120
95644494	VR-B201H	13	SAWAFUJI			72710302	VR-DU510	120
POONG SUNG			1219-004-00	VR-H2001-3	63	72710402	VR-DU510	120
235522	VR-K05	78	1219-005-00	VR-H2001-3	63	72710502	VR-B190	8
PORSCHE			1291-004-00X0	VR-H2001-3	63	72710502	VR-B191	9
90160320301	VR-B190	8	1291-006-00X0	VR-H2002-3	111	72710602	VR-DU510	120
90160320301	VR-B191	9	1291-007-00X0	VR-H2002-2	111	72710802	VR-DU510	120
90160320600	VR-B191	9	1291-008-00X0	VR-H2002-1	111	72711102	VR-B191	9
90160320600	VR-B190	8	SCANIA			72711102	VR-B190	8
90160320601	VR-B190	8	117253	VR-B209	14	72711202	VR-DU509	120
90160320601	VR-B191	9	117253	VR-B203	14	72711502	VR-DU509	120
90160320602	VR-B191	9	1501245	VR-B396	24	72711602	VR-DU510	120
90160320602	VR-B190	8	1501246	VR-B396	24	72717002	VR-B190	8
91160390100	VR-DU509	120	1502245	VR-B396	24	72717002	VR-B191	9
91160391301	VR-PR2700	128	225662	VR-B199-3	12	72717102	VR-DU510	120
92860315300	VR-B195M	11	229511	VR-B190	8	72717202	VR-B191	9
92860320700	VR-PR2700	128	229511	VR-B191	9	72717202	VR-B190	8
94460314100	VR-B195M	11	263903	VR-B191	9	72717302	VR-B190	8
94460314101	VR-B195M	11	263903	VR-B190	8	72717302	VR-B191	9
96460314100	VR-B196MH	11	280942	VR-B194	10	72717402	VR-B191	9
PRESTOLITE			305160	VR-B203	14	72717402	VR-B190	8
1861A726	VR-LC401		362645	VR-B203	14	SKODA		
20130227	VR-H2005-59	54	362645	VR-B209	14	907040114	VR-MP419	85
20130227	VR-H2005-59	54	SEAT			SONACOME		
594A-11	VR-LC401		3894469	VR-B193M	10	1117344	VR-B198	12
594A-14	VR-LC401		3899291	VR-B193M	10	SSANGYONG		
8393	VR-D001B	30	3899919	VR-B195M	11	66215-43006	VR-D502	32
8-393	VR-D001B	30	3980592	VR-B196M	11	STEYR		
83-93	VR-D001B	30	HB90600000	VR-B190	8	30800090740	VR-B193M	10
8-394	VR-D001B	30	HB90600000	VR-B191	9	609F090019	VR-B190	8
8-394	VR-D001B	30	NG98102329	VR-B193M	10	609F090019	VR-B191	9
83-94	VR-D001B	30	SEV MARCHAL			61000090742	VR-B193M	10
VSH-6401C	VR-D001B	30	33036	VR-DU510	120	610090021	VR-B199-3	12
VSH-6401CS	VR-D001B	30	33067	VR-DU510	120	61200090707	VR-B198	12
VSH-6401D	VR-D001B	30	33081	VR-DU510	120	614090017	VR-B191	9
VSH-6401ES	VR-D001B	30	33505	VR-DU509	120	614090017	VR-B190	8
RENAULT			33506	VR-DU510	120	61500090706	VR-B197	12
26563108	VR-B199-4	13	33518	VR-DU510	120	61500090729	VR-B198	12
5000255685	VR-B191	9	33519	VR-DU510	120	SUBARU		
5000255685	VR-B190	8	33522	VR-DU510	120	23733-A0010	VR-H2000-19	65
5000273021	VR-B190	8	33523	VR-DU509	120	23733-AA010	VR-H2000-19	65
5000273021	VR-B191	9	33524	VR-DU510	120	23812-AA000	VR-H2000-62	71
5001001392	VR-B191	9	33525	VR-DU510	120	23815-AA010	VR-H2000-15	64
5001001392	VR-B190	8	33532	VR-DU510	120	23815-AA050	VR-H2000-27	66
7700519493	VR-DU510	120	33538	VR-DU510	120	23815-AA090	VR-H2009-115	89
7700530749	VR-DU510	120	33544	VR-DU510	120	23815-AA140	VR-H2009-107	88
7700544686	VR-DU510	120	33545	VR-DU510	120	23815-AA150	VR-H2009-107	88
7700660469	VR-DU510	120	33546	VR-DU510	120	23815-AA160	VR-H2009-109	88
7700666179	VR-DU510	120	33548	VR-DU510	120	42990-7100	VR-H2000-32	68
7701008802	VR-B199-3	12	33549	VR-DU510	120	42990-7100	VR-H2000-1L	65
7701012214	VR-B199-4	13	33560	VR-DU510	120	42990-7100	VR-H2000-1	64
7701014809	VR-B191	9	33561	VR-DU510	120	42990-7100	VR-H2000-1H	65
7701014809	VR-B190	8	71270402	VR-DU509	120	49575-5601	VR-H2000-2	66
7701015670	VR-B199-4	13	71490602	VR-PR1000H	124	49575-7101	VR-H2000-1H	65
7701024524	VR-DU511	120	72160602	VR-B191	9	49575-7101	VR-H2000-1	64
7701027713	VR-DU511	120	72160602	VR-B190	8	49575-7101	VR-H2000-1L	65
7701028400	VR-PR1000H	124	72160702	VR-B190	8	49575-7101	VR-H2000-32	68
7701029095	VR-PR1000H	124	72160702	VR-B191	9	49575-7301	VR-H2000-32	68
7701030069	VR-DU511	120	72160902	VR-B191	9	49575-7301	VR-H2000-1L	65
7701030814	VR-PR126	124	72160902	VR-B190	8	49575-7301	VR-H2000-1	64
7701031737	VR-PR1000H	124	72210002	VR-B190	8	49575-7301	VR-H2000-1H	65
7701033171	VR-PR1000H	124	72210002	VR-B191	9	SUZUKI		

**CROSS REFERENCE
Voltage Regulator**

OEM No. → Mobiletron No.

OEM No.	Part No.	Page	OEM No.	Part No.	Page	OEM No.	Part No.	Page
32500-60A10	VR-H2009-14N	93	100207	VR-DU510	120	2548154E	VR-PR2765	128
32500-61J00	VR-H2009-147	91	133421122	VR-V5745	117	2548923	VR-PR3389	128
32500-82610	VR-H2005-7A	56	13480351	VR-V6131	117	2549916B	VR-V3666	115
32500-86511	VR-H2005-26A	50	139669	VR-MD01	86	2580429	VR-V2975	114
TALBOT			15926088	VR-V0441	112	2580469	VR-V3279	114
15224800	VR-DU509	120	182005	VR-PR126	124	2580499	VR-V2975	114
15224891	VR-DU509	120	182007	VR-PR128	125	2590512	VR-PR135	125
163009	VR-DU510	120	182008	VR-PR132B	125	2590537	VR-PR132B	125
30201E	VR-DU509	120	182011	VR-PR126	124	2590538	VR-PR2000H	127
373994J	VR-DU509	120	182013	VR-PR128	125	2590542	VR-PR2000H	127
42290B	VR-DU510	120	182046	VR-PR1000H	124	2590558	VR-PR126	124
43269200	VR-B205	14	182120	VR-PR2000H	127	2590558	VR-PR1000H	124
461138S	VR-DU509	120	20050526	VR-V5745	117	2590588	VR-PR1000H	124
55822700	VR-DU510	120	20051012	VR-V5001	116	2590588	VR-PR1000H	124
75062449	VR-LC100	80	20071017	VR-PR5011	129	2591559	VR-V3279	114
TOSHIBA			20080622	VR-PR5011	129	2591579	VR-V2604	113
S5476A	VR-H2001-3	63	20080710	VR-V5745	117	2591800	VR-V2975	114
TOYOTA			231425	VR-MD07	86	2591894	VR-V2604	113
27000-64040	VR-H2005-2W	51	234252	VR-H2009-116	78	2601726	VR-PR2765	128
27000-64040	VR-H2005-2	48	235551	VR-H2009-128	91	2603741	VR-V3689	115
27060-0C020	VR-H2005-85	56	2518044	VR-VW009	123	2604114	VR-V4114	116
27060-0C021	VR-H2005-85	56	2519124	VR-VW005N	122	2604289	VR-V3975	116
27700-01010	VR-H2005-4A	53	2519490	VR-VW005N	122	2604920	VR-PR4920	129
27700-0L020	VR-B243	16	2521335	VR-VW010	123	2605120	VR-V5120	116
27700-10050	VR-H2005-23A	50	2521760	VR-VW005N	122	2605460	VR-V5460	117
27700-10061	VR-H2005-4A	53	2521766	VR-VW005N	122	2605597	VR-PR2292H	127
27700-10080	VR-H2005-23A	50	2522098	VR-VW005N	122	2605904	VR-V2871	114
27700-11030	VR-H2005-4A	53	2522939	VR-VW005N	122	2605904	VR-V5904	117
27700-11050	VR-H2005-4A	53	2523198	VR-VW005N	122	2606243A	VR-V0447	112
27700-11060	VR-H2005-32A	51	2541137	VR-PR1000H	124	2607089	VR-PR5023	129
27700-11070	VR-H2005-30A	51	2541192	VR-PR1926	126	2607131	VR-V7131	118
27700-1700	VR-H2002-1	111	2541193	VR-PR1926	126	2607144	VR-V7144	118
27700-20050	VR-H2005-63A	55	2541392	VR-VW010	123	2608222	VR-V2975	114
27700-20090	VR-H2005-85	56	2541404	VR-VW010	123	2608326	VR-V8326	118
27700-20100	VR-H2005-85	56	2541406	VR-PR1667	126	2608417A	VR-V8417	119
27700-21020	VR-H2005-65	55	2541433	VR-VW010	123	2609938	VR-V9938	119
27700-21040	VR-H2005-197	47	2541484	VR-VW005N	122	2609960	VR-V3536	115
27700-21050	VR-H2005-100	41	2541493	VR-VW010	123	2610118	VR-V3780	115
27700-26050	VR-H2005-1	41	2541496	VR-PR1667	126	2610119	VR-V2975	114
27700-27070	VR-H2005-179	46	2541666	VR-VW010	123	2610181	VR-V3591	115
27700-28030	VR-H2005-1	41	2541667	VR-VW010	123	2611164	VR-V2775	113
27700-31040	VR-H2005-105	42	2541682	VR-VW010	123	2612263	VR-V2263	113
27700-35040	VR-H2005-31A	51	2541715	VR-PR1669	126	2612671	VR-V7319	118
27700-38100	VR-H2005-1	41	2541715B	VR-PR1669	126	2612988	VR-V2988	114
27700-40050	VR-H2005-31A	51	2541721	VR-VW010	123	2616783	VR-V5460	117
27700-41050	VR-H2005-1	41	2541800	VR-VW010	123	2617059	VR-V7059	117
27700-43010	VR-H2005-3	51	2541935B	VR-PR1935	127	2618052	VR-V8052	118
27700-44040	VR-H2005-3	51	2541939B	VR-V1610	113	2618054B	VR-V8054	118
27700-45020	VR-H2005-1	41	2542204	VR-PR3617H	129	2618054M	VR-V8054	118
27700-45021	VR-H2005-1	41	2542209B	VR-PR3617H	129	2618060B	VR-V8060	118
27700-46030	VR-H2005-18A	47	2542213	VR-PR3389	128	2618689	VR-V8689	119
27700-46040	VR-H2005-18A	47	2542222B	VR-PR2222	127	2621055	VR-V7319	118
27700-46060	VR-H2005-63A	55	2542288	VR-PR2288	127	2650030	VR-V0030	112
27700-50020	VR-H2005-30A	51	2542299	VR-PR2299H	127	2650219	VR-V0219	112
27700-50030	VR-H2005-30A	51	2542339B	VR-PR2339	128	2650348	VR-V0219	112
27700-50040	VR-H2005-64A	55	2542349	VR-V1610	113	2650441	VR-V0441	112
27700-54050	VR-H2005-4A	53	2542419	VR-PR3430	128	2650447	VR-V0447	112
27700-54060	VR-H2005-30A	51	2542482	VR-V1610	113	2650473	VR-V0219	112
27700-57050	VR-H2005-12	42	2542499	VR-V2499	113	2650490	VR-PR2765	128
27700-57060	VR-H2005-11	42	2542549B	VR-V3419	114	2650557	VR-V0441	112
27700-58020	VR-H2005-58	54	2542549B	VR-V3419SE	114	2650561	VR-V0441	112
27700-58040	VR-H2005-66	55	2542566	VR-V3779	115	2655001	VR-V5001	116
27700-62010	VR-H2005-63A	55	2542599	VR-V2599	113	2655428	VR-V5428	117
27700-63020	VR-H2005-4A	53	2542655	VR-V2263	113	2655479	VR-V5001	116
27700-63021	VR-H2005-4A	53	2542711	VR-V3689	115	2655633	VR-V5633	117
27700-64110	VR-H2005-2	48	2542765	VR-PR2765	128	2808323	VR-PR1669	126
27700-64130	VR-H2005-63A	55	2542765C	VR-PR2765	128	2940022	VR-VW005N	122
27700-65010	VR-H2005-31A	51	2542775	VR-V2775	113	2940318	VR-VW005N	122
27700-66040	VR-H2005-30A	51	2542885	VR-V3780	115	2940328	VR-VW005N	122
27700-70030	VR-H2005-17A	46	2542919	VR-V5120	116	2941121	VR-VW005N	122
27700-70030	VR-H2005-4A	53	2542934	VR-PR3534	128	300663	VR-PR128	125
27700-72040	VR-H2005-4A	53	2542957	VR-V2975	114	300667	VR-PR130	125
27700-72041	VR-H2005-4A	53	2542964	VR-V3279	114	300668	VR-PR1000H	124
27700-72070	VR-H2005-4A	53	2543200	VR-V3796	116	300668	VR-PR1000H	124
27700-72090	VR-H2005-18A	47	2543231	VR-V3231	114	300669	VR-PR123	124
27700-74010	VR-H2005-33A	51	2543279	VR-V3279	114	300675	VR-PR130	125
27700-74030	VR-H2005-31A	51	2543327B	VR-PR2206	127	300676	VR-PR130	125
27700-74040	VR-H2005-30A	51	2543505	VR-V2604	113	300685	VR-PR128	125
27700-75030	VR-H2005-100	41	2543535	VR-V2604	113	300692	VR-PR135	125
27700-78301	VR-H2005-39	52	2543546	VR-V3780	115	300725	VR-PR126	124
449023R08	VR-H2005-107	42	2543591	VR-V3591	115	300741	VR-PR135	125
VALEO			2543917	VR-V3780	115	300744	VR-PR135B	125
092962Y	VR-PR128B	125	2545472	VR-VW010	123	300744	VR-PR135BA	125
092991	VR-PR2700	128	2546366C	VR-PR6366	130	300795	VR-PR1000H	124
100065	VR-DU510	120	2546493C	VR-PR6366	130	300806	VR-PR1000H	124

**CROSS REFERENCE
Voltage Regulator**

**CROSS REFERENCE
Rectifier**

**CROSS REFERENCE
Diode Trio**

**ALTERNATOR NO.
Reg & Rec**

**CROSS REFERENCE
Voltage Regulator**

OEM No. → Mobiletron No.

OEM No.	Part No.	Page	OEM No.	Part No.	Page	OEM No.	Part No.	Page
300820	VR-PR2000H	127	593139	VR-VW010	123	595411	VR-V4803	116
300830	VR-PR2000H	127	593140	VR-PR1671	126	595458	VR-V2975	114
300868	VR-PR1000H	124	593191	VR-PR2000H	127	595464	VR-V3536	115
300871	VR-PR2700	128	593260	VR-PR3960	129	599101	VR-V3796	116
300883	VR-PR126	124	593263	VR-V2604	113	599119	VR-V3788	115
300884	VR-PR2000H	127	593284	VR-PR6603H	130	599149	VR-V3591	115
300894	VR-PR1000H	124	593290	VR-PR002H	124	599171	VR-V7059	117
300901	VR-PR1000H	124	593301	VR-VW010	123	599182	VR-V4291	116
3544570	VR-B201H	13	593305	VR-PR1060H	124	599194	VR-V4291	116
3ER1071	VR-MD04	86	593310	VR-PR002H	124	599212	VR-V2988	114
42785	VR-MD04	86	593312	VR-VW010	123	599228	VR-V2988	114
505001	VR-VW002	122	593316	VR-PR1620H	126	599233	VR-V8052	118
505003	VR-VW002	122	593318	VR-PR1060H	124	599237	VR-V8060	118
505005	VR-VW002	122	593319	VR-PR003H	124	599296	VR-V7059	117
505008	VR-VW002	122	593326	VR-VW010	123	599340	VR-V3722	115
505009	VR-VW002	122	593333	VR-PR3617H	129	599340	VR-V3788	115
505010	VR-VW002	122	593338	VR-PR1620H	126	70335	VR-DU510	120
505011	VR-VW002	122	593342	VR-PR1935	127	70747	VR-DU510	120
505016	VR-VW002	122	593347	VR-PR3617H	129	71854	VR-DU510	120
505018	VR-VW002	122	593349	VR-PR002H	124	74547	VR-DU510	120
505019	VR-VW003	122	593350	VR-VW010	123	76722	VR-DU510	120
505020	VR-VW003	122	593362	VR-V1610	113	76833	VR-DU510	120
505025	VR-VW002	122	593371	VR-PR2292H	127	76834	VR-DU510	120
505028	VR-VW002	122	593375	VR-PR2288	127	77224	VR-DU510	120
505029	VR-VW002	122	593384	VR-PR2299H	127	77616	VR-DU509	120
505030	VR-VW002	122	593389	VR-PR3389	128	78700	VR-B190	8
505031	VR-VW003	122	593391	VR-PR3617H	129	78700	VR-B191	9
505032	VR-VW003	122	593396	VR-PR2299H	127	78819	VR-DU510	120
505043	VR-B190	8	593406	VR-V3406SE	114	79343	VR-DU510	120
505043	VR-B191	9	593411	VR-PR1620H	126	79368	VR-DU510	120
505044	VR-LC100	80	593419	VR-V3419	114	79583	VR-DU510	120
505045	VR-DU510	120	593419	VR-V3419SE	114	79584	VR-DU510	120
505046	VR-DU509	120	593430	VR-PR3430	128	79628	VR-DU510	120
505048	VR-DU510	120	593434	VR-V1658	113	79905	VR-DU509	120
505049	VR-DU510	120	593454	VR-V3874	116	809163	VR-H2009-75	106
505050	VR-F110A	82	593455	VR-PR2292H	127	811883	VR-H2009-75	106
505051	VR-F110A	82	593455	VR-PR2292H	127	92361	VR-DU510	120
505052	VR-LC100	80	593466	VR-V1658	113	92782	VR-DU510	120
505053	VR-F110A	82	593477	VR-PR3534	128	92860	VR-PR1000H	124
505054	VR-F110B	82	593480	VR-PR2292H	127	92867	VR-PR123	124
505055	VR-B192	9	593505	VR-PR3534	128	92897	VR-PR2000H	127
505-055	VR-B193M	10	593522	VR-PR2292H	127	92901	VR-PR128B	125
505059	VR-B197	12	593529	VR-PR3529	128	92902	VR-PR2000H	127
505069	VR-VW003	122	593532	VR-V2599	113	92918	VR-PR130	125
505070	VR-VW002	122	593534	VR-PR3534	128	92927	VR-PR1000H	124
505072	VR-VW003	122	593536	VR-V2263	113	92930	VR-PR130	125
505078	VR-VW002	122	593666	VR-V3666	115	92933	VR-PR130	125
505082	VR-VW002	122	593689	VR-V3689	115	92937	VR-PR126	124
505083	VR-VW002	122	593779	VR-V3779	115	92940	VR-PR2000H	127
505096	VR-LC100	80	593780	VR-V3780	115	92955	VR-PR127B	125
505099	VR-VW002	122	593793	VR-V3793	115	92962	VR-PR128B	125
505100	VR-VW005N	122	593796	VR-V3796	116	92966	VR-PR135	125
505105	VR-VW005N	122	593813	VR-PR2292H	127	92981	VR-PR2000H	127
505180	VR-VW002	122	593818	VR-PR3389	128	92982	VR-PR126	124
572587	VR-B200H	13	593857	VR-V2775	113	92990	VR-PR126	124
590512	VR-PR135	125	593874	VR-V3874	116	92991	VR-PR128	125
590536	VR-PR3729A	129	593877	VR-V3231	114	95394	VR-DU510	120
590538	VR-PR2000H	127	593918	VR-V3796	116	96126	VR-DU510	120
590558	VR-PR1000H	124	593940	VR-PR2292H	127	96637	VR-DU510	120
590640	VR-PR128B	125	593941	VR-PR2292H	127	96731	VR-DU510	120
590660	VR-PR126	124	593941	VR-PR2292H	127	97163	VR-B191	9
590679	VR-PR1000H	124	593942	VR-PR2292H	127	97163	VR-B190	8
590688	VR-PR1926	126	593943	VR-PR2293	127	97343	VR-DU510	120
590704	VR-PR2000H	127	593958	VR-V3279	114	97382	VR-DU510	120
591894	VR-V2604	113	593970	VR-V4291	116	99464	VR-DU510	120
592781	VR-VW005N	122	593975	VR-V3975	116	9RC2047	VR-PR1926	126
592791	VR-VW010	123	593984	VR-V3231	114	9RC2055	VR-PR1667	126
592792	VR-VW009	123	593987	VR-V2975	114	9RC2062	VR-PR1667	126
592793	VR-PR1667	126	593993	VR-V5120	116	9RC6065	VR-VW010	123
592797	VR-VW010	123	595211	VR-PR2206	127	9RC7108	VR-PR1620H	126
592800	VR-VW010	123	595243	VR-V3279	114	A500C0111	VR-H2009-75	106
592801	VR-VW010	123	595252	VR-V8237	118	A518052A	VR-PR126	124
592803	VR-PR2000H	127	595253	VR-V8237	118	A519124A	VR-VW005N	122
592806	VR-VW005N	122	595265	VR-V3796	116	A521760A	VR-VW005N	122
592838	VR-VW002	122	595291	VR-V7059	117	A541184A	VR-PR128B	125
592888	VR-VW005N	122	595318	VR-V3591	115	A554616A	VR-LC100	80
592910	VR-VW010	123	595332	VR-V3722	115	A554711A	VR-LC111	80
592911	VR-VW010	123	595332	VR-V3788	115	A56536A	VR-H2000-29A-2	67
592952	VR-VW005N	122	595339	VR-V5339	116	A56536A	VR-H2000-29C	67
592963	VR-VW005N	122	595365	VR-V2604	113	A56536A	VR-H2000-29	66
5931138	VR-PR1669	126	595366	VR-V5366	117	A564796A	VR-D674	33
593131	VR-VW010	123	595379	VR-V8237	118	A808239A	VR-PR1667	126
593132	VR-PR1671	126	595385	VR-V3975	116	A808422A	VR-VW010	123
593133	VR-VW010	123	595389	VR-V5904	117	A940318A	VR-VW005N	122
593135	VR-PR7736	130	595393	VR-V4291	116	M903	VR-MD06L	86

**CROSS REFERENCE
Voltage Regulator**

OEM No. → Mobiletron No.

OEM No.	Part No.	Page	OEM No.	Part No.	Page	OEM No.	Part No.	Page
NB163	VR-VW002	122	YV1969T	VR-VW010	123	8381	VR-DU510	120
NB165	VR-VW002	122	YV2700	VR-PR2700	128	8382	VR-DU510	120
NB166	VR-VW002	122	YV3970H	VR-VW010	123	VALEO(MOTOROLA)		
NB175	VR-DU510	120	YV49	VR-VW005N	122	105229	VR-VW007	122
NB180	VR-LC100	80	YV4904	VR-VW005N	122	105246	VR-VW006	122
NB188	VR-VW003	122	YV77	VR-PR135	125	2522939	VR-VW005N	122
NB191	VR-VW002	122	YV7735	VR-PR135	125	2541141	VR-VW009	123
NB193	VR-VW002	122	YV99	VR-VW005N	122	2940022	VR-VW005N	122
NB411	VR-B193M	10	YV9911	VR-VW005N	122	2940030	VR-VW005N	122
NB412	VR-B197	12	YV9966T	VR-VW010	123	2940305	VR-VW005N	122
NB413	VR-VW002	122	ZL126	VR-PR128B	125	2940305A	VR-VW005N	122
NB414	VR-VW003	122	ZL128	VR-PR128B	125	2940318	VR-VW005N	122
NB417	VR-VW002	122	ZV3928	VR-PR128B	125	8RL3007	VR-VW007	122
NB431	VR-VW002	122	VALEO(DUCELLIER)			8RL3011	VR-VW006	122
NB456	VR-VW002	122	505-100	VR-VW005N	122	9RC2003	VR-VW002	122
NB466	VR-VW002	122	505-105	VR-VW005N	122	9RC2006	VR-VW002	122
NB468	VR-VW003	122	510002	VR-DU510	120	9RC2018	VR-VW005N	122
NB492	VR-VW005N	122	510003	VR-B191	9	9RC2021	VR-VW005N	122
NB926	VR-DU512	120	510003	VR-B190	8	9RC2054	VR-VW010	123
NB928	VR-DU512	120	510004	VR-DU510	120	9RC6065	VR-VW010	123
NB973	VR-DU509	120	510005	VR-DU510	120	9RC6074	VR-PR1669	126
NB982	VR-DU511	120	511006	VR-DU511	120	9RC7002	VR-VW002	122
NB985	VR-DU514	121	511008	VR-DU511	120	9RC7003	VR-VW002	122
NB986	VR-DU514	121	511010	VR-DU511	120	9RC7004	VR-VW002	122
NB987	VR-DU513	121	511015	VR-DU514	121	9RC7008	VR-VW002	122
NB988	VR-DU515	121	511015	VR-DU515	121	9RC7020	VR-VW002	122
NC171	VR-PR128B	125	511015	VR-DU512	120	9RC7022	VR-VW002	122
NC175	VR-PR126	124	511018	VR-DU513	121	9RC7024	VR-VW003	122
NC176	VR-PR126	124	511022	VR-DU511	120	9RC7025	VR-VW003	122
NC178	VR-PR2000H	127	511023	VR-DU512	120	9RC7028	VR-VW002	122
NC184	VR-PR135B	125	511024	VR-DU511	120	9RC7031	VR-VW002	122
NC184	VR-PR135BA	125	519001	VR-DU510	120	9RC7036	VR-VW002	122
NC187	VR-PR2000H	127	519002	VR-B190	8	9RC7037	VR-LC100	80
NC189	VR-PR1000H	124	519002	VR-B191	9	9RC7038	VR-VW002	122
NC191	VR-PR126	124	519004	VR-DU509	120	9RC7041	VR-VW003	122
NC192	VR-PR1000H	124	581255	VR-DU511	120	9RC7042	VR-VW003	122
NC313	VR-PR2000H	127	581256	VR-DU511	120	9RC7056	VR-VW003	122
NC328	VR-B190	8	581257	VR-DU512	120	9RC7057	VR-VW003	122
NC328	VR-B191	9	582991	VR-DU512	120	9RC7059	VR-VW002	122
NC333	VR-DU510	120	592806	VR-VW005N	122	9RC7062	VR-B192	9
NC334	VR-DU509	120	592967	VR-F119	82	9RC7063	VR-VW002	122
NC362	VR-PR135	125	592968	VR-F119B	83	9RC7065	VR-VW002	122
NC692	VR-PR127B	125	592983	VR-D673C	33	9RC7071	VR-VW002	122
NC886	VR-DU510	120	592984	VR-D676	34	9RC7073	VR-VW002	122
NC927	VR-PR135	125	592989	VR-VW005N	122	9RC7088	VR-VW005N	122
NC985	VR-VW010	123	690587	VR-DU511	120	9RC7093	VR-VW002	122
NC987	VR-PR1667	126	690645	VR-DU511	120	9RC7104	VR-VW005N	122
NF076	VR-PR1669	126	690686	VR-DU511	120	9RC8090	VR-B197	12
RTM151A	VR-PR1669	126	691097	VR-DU511	120	9RH7005	VR-B190	8
TA500C0041	VR-H2009-187	75	691112	VR-DU512	120	9RH7005	VR-B191	9
TA500C02401	VR-H2009-86	86	691140	VR-DU512	120	9RH7013	VR-DU510	120
VR-231	VR-F784H	59	691146	VR-DU514	121	9RH7014	VR-DU509	120
YH1655	VR-PR1000H	124	691170	VR-DU514	121	9RH7016	VR-DU510	120
YH2700	VR-PR2700	128	691183	VR-DU512	120	9RH7017	VR-DU510	120
YM1424P1	VR-PR1620H	126	691191	VR-DU513	121	9RH7021	VR-F110A	82
YM1610F	VR-V1610	113	691253	VR-DU511	120	9RH7029	VR-F110A	82
YM1620	VR-PR1620H	126	691292	VR-DU511	120	9RH7044	VR-F110A	82
YM1622P	VR-PR1620H	126	691303	VR-DU512	120	9RH8043	VR-F110B	82
YM1636P1	VR-PR2299H	127	691338	VR-DU512	120	VALEO(PARIS RHONE)		
YM1658	VR-V1658	113	691406	VR-DU512	120	593675	VR-PR4920	129
YM1662P	VR-PR1620H	126	691428	VR-DU511	120	599121	VR-PR4920	129
YM1666FP5	VR-V3874	116	691458	VR-DU512	120	599123	VR-PR4920	129
YM1689PF	VR-V3666	115	691468	VR-DU511	120	A14N100M	VR-PR3729A	129
YM1693VFP	VR-V3779	115	691617	VR-DU512	120	A14N119M	VR-PR3729A	129
YM1949	VR-VW010	123	694548	VR-DU512	120	A14N122M	VR-PR3729A	129
YM1950	VR-VW010	123	694617	VR-DU512	120	A14N137	VR-PR3729A	129
YM3953	VR-VW010	123	8320	VR-DU510	120	A14N141M	VR-PR3729A	129
YM6555	VR-VW010	123	8327	VR-DU510	120	AY21	VR-DU510	120
YM6952	VR-VW010	123	8328	VR-DU510	120	AY21T	VR-DU510	120
YM6955	VR-VW010	123	8347	VR-DU510	120	AYA21	VR-DU510	120
YM9980	VR-VW010	123	8349	VR-DU510	120	AYA210	VR-DU510	120
YR 6604	VR-PR3534	128	8350	VR-DU510	120	AYA2114	VR-DU509	120
YR0636D15	VR-V3780	115	8357	VR-DU510	120	AYA213	VR-DU510	120
YR1615PF	VR-V3689	115	8358	VR-DU509	120	AYB21	VR-DU510	120
YR3634VFP2	VR-V3406SE	114	8362	VR-DU510	120	AYB210	VR-DU510	120
YR66P	VR-PR3534	128	8364	VR-DU510	120	AYB211	VR-DU510	120
YV0913H	VR-VW009	123	8367	VR-DU509	120	AYB2110	VR-DU510	120
YV1654	VR-PR126	124	8371	VR-DU510	120	AYB2113	VR-DU510	120
YV1655	VR-PR1000H	124	8372	VR-DU510	120	AYB2115	VR-DU510	120
YV1867H	VR-PR1667	126	8373	VR-DU509	120	AYB2116	VR-DU510	120
YV1923	VR-VW005N	122	8375	VR-B191	9	AYB2118	VR-DU510	120
YV1926	VR-PR1926	126	8375	VR-B190	8	AYB2119	VR-DU510	120
YV1928	VR-VW010	123	8376	VR-DU510	120	AYB212	VR-DU510	120
YV1965T	VR-VW010	123	8378	VR-DU510	120	AYB2123	VR-DU510	120
YV1966T	VR-VW010	123	8380	VR-DU509	120	AYB2124	VR-DU510	120

CROSS REFERENCE
Voltage Regulator

CROSS REFERENCE
Rectifier

CROSS REFERENCE
Diode Trio

ALTERNATOR NO.
Reg & Rec

**CROSS REFERENCE
Voltage Regulator**

OEM No. → Mobiletron No.

OEM No.	Part No.	Page	OEM No.	Part No.	Page	OEM No.	Part No.	Page
AYB2125	VR-DU510	120	ZL126	VR-PR128B	125	249264	VR-B199-3	12
AYB2128	VR-DU510	120	ZL127	VR-PR127B	125	292243	VR-DU510	120
AYB213	VR-DU510	120	ZL128	VR-PR128B	125	3292243	VR-DU510	120
AYB214	VR-DU509	120	ZL129	VR-PR135B	125	4785003	VR-B199-4	13
AYB215	VR-DU510	120	ZL129	VR-PR135BA	125	870864	VR-B199-3	12
AYB216	VR-DU509	120	ZL132	VR-PR132B	125	VW/BRAZIL		
AYB218	VR-DU510	120	ZL134	VR-PR132B	125	409038031	VR-B211	15
AYC2112	VR-B191	9	ZV 3729	VR-PR3729A	129	YANMAR		
AYC2112	VR-B190	8	ZV3928	VR-PR128B	125	0124080-77390	VR-H2000-2	66
YH 2700	VR-PR2700	128	ZV3932	VR-PR132B	125	119129-77820	VR-H2000-2B	67
YH0601	VR-PR4920	129	ZV3960H	VR-PR3960	129	119773-77200	VR-H2005-59	54
YH1639	VR-PR126	124	ZV3963T	VR-PR3430	128	XTR1Z-44	VR-H2000-2	66
YH1649	VR-PR1000H	124	ZY 3729	VR-PR3729A	129	XTR1Z-63	VR-H2000-2	66
YH1652	VR-PR1000H	124	VERSORGUNGS					
YH1654	VR-PR1000H	124	2920-12-158-8890	VR-B199-3	12			
YH1903	VR-PR128	125	VOLKSWAGEN					
YH1925	VR-PR2000H	127	028903803F	VR-VW010	123			
YH1928	VR-PR128	125	0409038032	VR-B102	6			
YH1933	VR-PR2000H	127	06F903803	VR-B296	21			
YH2602	VR-PR126	124	06F903803A	VR-B296	21			
YH2605	VR-PR126	124	06F903803AX	VR-B296	21			
YH2606	VR-PR126	124	06H 903 803 E	VR-B807	25			
YH2701	VR-PR2000H	127	06H903803B	VR-B6164	25			
YH2925	VR-PR2000H	127	06H903803D	VR-B6164	25			
YL122	VR-PR1000H	124	070903803B	VR-B296	21			
YL123	VR-PR123	124	070903803E	VR-B296	21			
YL123B	VR-PR123	124	078903803A	VR-VW010	123			
YL124	VR-PR2000H	127	078903803B	VR-VW010	123			
YL125	VR-PR2000H	127	078903803E	VR-B296	21			
YL126	VR-PR126	124	2TB903803A	VR-B396	24			
YL128	VR-PR128	125	VOLVO					
YL129	VR-PR1000H	124	01214719	VR-B190	8			
YL130	VR-PR130	125	01214719	VR-B191	9			
YL131	VR-PR130	125	102746	VR-B199-3	12			
YL132	VR-PR2000H	127	1234519	VR-B191	9			
YL133	VR-PR2000H	127	1234519	VR-B190	8			
YL134	VR-PR123	124	1308030	VR-B190	8			
YL135	VR-PR135	125	1308030	VR-B191	9			
YL136	VR-PR130	125	1323467	VR-B194	10			
YL137	VR-PR128	125	1324617	VR-B196MH	11			
YL138	VR-PR126	124	1606935	VR-B209	14			
YL139	VR-PR126	124	1606935	VR-B203	14			
YL140	VR-PR130	125	1625880	VR-B203	14			
YL141	VR-PR130	125	1625880	VR-B209	14			
YL142	VR-PR130	125	1698185	VR-B203	14			
YL142	VR-DU509	120	1698764	VR-B206	14			
YL143	VR-PR123	124	241534	VR-B191	9			
YL145	VR-PR128	125	241534	VR-B190	8			
YL146	VR-PR135	125	241808	VR-B190	8			
YL147	VR-PR135	125	241808	VR-B191	9			
YL149	VR-PR1000H	124	241960	VR-B191	9			
YL151	VR-PR126	124	241960	VR-B190	8			
YL152	VR-PR1000H	124	244332	VR-B192	9			
YL154	VR-PR1000H	124	244344	VR-B197	12			
YL155	VR-PR1000H	124	244426	VR-B197	12			
YL411	VR-DU510	120	244489	VR-B194	10			
YL414	VR-B190	8	244612	VR-B194	10			
YL414	VR-B191	9	246585	VR-B190	8			
YM10607P	VR-PR1060H	124	246585	VR-B191	9			
YM1600	VR-PR002H	124	248279	VR-B191	9			
YM1606P1	VR-PR1060H	124	248279	VR-B190	8			
YM1626F	VR-PR2292H	127	300667453	VR-B056	5			
YM1652	VR-PR1000H	124	300667454	VR-B056	5			
YM1672	VR-PR2292H	127	31285808	VR-V4291	116			
YM1919P1	VR-PR003H	124	3239266	VR-B203	14			
YM2618P1	VR-PR3617H	129	3343913	VR-PR2000H	127			
YM3617PIC	VR-PR3617H	129	3523710-6	VR-B196MH	11			
YM6951	VR-PR1669	126	3600909	VR-V4291	116			
YM6956	VR-PR2288	127	530878	VR-B191	9			
YV1060P	VR-PR1060H	124	530878	VR-B190	8			
YV10673H	VR-PR1671	126	531914	VR-B190	8			
YV126	VR-PR126	124	531914	VR-B191	9			
YV1652	VR-PR126	124	588950	VR-B191	9			
YV1652	VR-PR1000H	124	588950	VR-B190	8			
YV1654	VR-PR1000H	124	6212039	VR-B190	8			
YV1667H	VR-PR1667	126	6212039	VR-B191	9			
YV1903	VR-PR128	125	6877982	VR-DU509	120			
YV1924	VR-PR2000H	127	9600908	VR-B203	14			
YV1926T	VR-PR1926	126	VOLVO/DAF					
YV1933	VR-PR2000H	127	01215477	VR-DU510	120			
YV2605	VR-PR126	124	01215565	VR-DU510	120			
YV2925	VR-PR2000H	127	114374	VR-DU510	120			
YV3670	VR-PR1671	126	1259303	VR-DU510	120			
YV3932	VR-PR132B	125	215565	VR-DU510	120			
YV7736	VR-PR7736	130	241630	VR-B199-3	12			

**CROSS REFERENCE
Rectifier**

OEM No. → Mobiletron No.

OEM No.	Part No.	Page	OEM No.	Part No.	Page	OEM No.	Part No.	Page
ALFA ROMEO			BOSCH			1-127-319-766	RB-32H	151
116.0005.061.00	RB-12H	145	111233	RD-06	159	1127319778	RB-33H	151
116.0005.061.21	RB-12H	145	111240	RD-06	159	1-127-319-862	RB-101H	141
116.1005.060.04	RB-02H	140	1-125-715-064	RB-124H	144	1127320101	RB-01HA	140
116.1005.060.08	RB-02H	140	1-125-715-064	RB-123H	144	1-127-320-102	RB-11H	144
116.1005.060.13	RB-02H	140	1-125-715-065	RB-123H	144	1127320103	RB-01HA	140
119.1305.061.00	RB-02H	140	1-125-715-065	RB-124H	144	1127320105	RB-01HA	140
119.1305.061.21	RB-02H	140	1-127-011-095	RB-07H	141	1127320108	RB-01HA	140
208000000	RB-11H	144	1-127-011-096	RB-07H	141	1-127-320-110	RB-02H	140
700.2080.000.00	RB-11H	144	1-127-011-097	RB-07H	141	1-127-320-114	RB-11H	144
700208	RB-11H	144	1-127-011-098	RB-08H	141	1-127-320-115	RB-13H	146
701655	RB-01HA	140	1-127-011-101	RB-08H	141	1-127-320-116	RB-13H	146
AUDI/VW			1-127-011-103	RB-07H	141	1-127-320-117	RB-02H	140
028903359A	RB-01HA	140	1127011112	RB-01HA	140	1-127-320-118	RB-12H	145
036903359B	RB-01HA	140	1127011113	RB-01HA	140	1127320119	RB-01HA	140
036903359E	RB-05H	141	1127011114	RB-01HA	140	1127320120	RB-01HA	140
036903359F	RB-05H	141	1127011115	RB-01HA	140	1-127-320-121	RB-12H	145
036903359G	RB-05H	141	1-127-011-116	RB-03HA	140	1-127-320-122	RB-11H	144
036903359H	RB-05H	141	1-127-011-117	RB-02H	140	1-127-320-124	RB-11H	144
036903359J	RT-10H	227	1-127-011-118	RB-02H	140	1127320125	RB-01HA	140
037903359A	RB-54H	153	1-127-011-119	RB-02H	140	1-127-320-128	RB-02H	140
038903359D	RB-926H	156	1-127-011-120	RB-02H	140	1127320130	RB-01HA	140
046903359A	RB-02H	140	1-127-011-121	RB-02H	140	1127320134	RB-01HA	140
046903359B	RB-01HA	140	1-127-011-123	RB-02H	140	1127320136	RB-01HA	140
049903359D	RB-72H	154	1-127-011-124	RB-02H	140	1127320138	RB-01HA	140
049903359E	RB-01HA	140	1-127-011-125	RB-02H	140	1-127-320-139	RB-02H	140
049903359F	RB-01HA	140	1-127-011-128	RB-02H	140	1127320140	RB-01HA	140
052903371A	RB-01HA	140	1127011130	RB-01HA	140	1-127-320-141	RB-13H	146
053903359C	RB-43H	152	1-127-011-131	RB-16H	148	1-127-320-142	RB-13H	146
056903359B	RB-02H	140	1127011135	RB-01HA	140	1127320143	RB-01HA	140
056903371A	RB-01HA	140	1-127-011-138	RB-02H	140	1127320144	RB-01HA	140
056903371B	RB-02H	140	1-127-011-139	RB-06HA	141	1127320145	RB-01HA	140
059903371A	RB-01HA	140	1-127-011-140	RB-02H	140	1-127-320-146	RB-13H	146
059903371B	RB-01HA	140	1-127-011-157	RB-41H	152	1-127-320-147	RB-07H	141
068903539B	RB-04H	140	1-127-319-005	RB-32H	151	1-127-320-148	RB-02H	140
068903539C	RB-04H	140	1-127-319-009	RB-101H	141	1-127-320-149	RB-02H	140
069903359A	RB-46H	152	1-127-319-011	RB-134H	145	1-127-320-150	RB-02H	140
069903359D	RB-04H	140	1127319013	RB-33H	151	1-127-320-151	RB-11H	144
26903359	RB-54H	153	1-127-319-019	RB-30H	151	1-127-320-152	RB-10H	142
27903359	RB-54H	153	1-127-319-031	RB-29H	151	1127320155	RB-01HA	140
28903359	RB-01HA	140	1-127-319-033	RB-26H	151	1127320157	RB-01HA	140
46903359	RB-02H	140	1-127-319-035	RB-108H	142	1127320158	RB-01HA	140
49903359	RB-01HA	140	1-127-319-104	RB-74H	155	1127320160	RB-01HA	140
52903371	RB-01HA	140	1127319113	RB-38H	151	1127320163	RB-01HA	140
56903359	RB-02H	140	1127319510	RB-121H	144	1-127-320-170	RB-02H	140
56903371	RB-01HA	140	1-127-319-512	RB-28H	151	1-127-320-171	RB-02H	140
59903359	RB-01HA	140	1-127-319-522	RB-36H	151	1-127-320-173	RB-11H	144
59903511	RB-01HA	140	1-127-319-530	RB-37H	151	1127320174	RB-01HA	140
68903359	RB-03HA	140	1127319540	RB-107H	142	1127320175	RB-01HA	140
75903359	RB-56H	153	1-127-319-552	RB-122H	144	1127320176	RB-01HA	140
9861217187	RB-01HA	140	1-127-319-558	RB-110H	142	1127320178	RB-01HA	140
98612171877	RB-01HA	140	1-127-319-560	RB-134H	145	1127320181	RB-01HA	140
BL/JAGUAR			1-127-319-562	RB-110H	142	1127320183	RB-01HA	140
37H6913	RL-08HV	197	1-127-319-568	RB-110H	142	1-127-320-184	RB-02H	140
37H6924	RL-12H	197	1-127-319-570	RB-105H	142	1127320185	RB-01HA	140
37H7965	RL-13	197	1127319572	RB-107H	142	1-127-320-187	RB-02H	140
37H7965	RL-13H	197	1127319572	RB-107H	142	1-127-320-188	RB-02H	140
606829	RL-12H	197	1127319576	RB-178H	148	1-127-320-189	RB-02H	140
607688	RL-08HV	197	1-127-319-580	RB-26H	151	1-127-320-190	RB-02H	140
90607688	RL-08HV	197	1-127-319-584	RB-160H	147	1-127-320-192	RB-10H	142
AAU8483	RL-15H	198	1127319593	RB-121H	144	1-127-320-195	RB-02H	140
AAU8483	RL-15	198	1127319597	RB-33H	151	1-127-320-196	RB-02H	140
BAU1830	RL-15	198	1-127-319-599	RB-37H	151	1-127-320-197	RB-02H	140
BAU1830	RL-15H	198	1-127-319-601	RB-32H	151	1127320277	RB-01HA	140
JS486	RL-08HV	197	1-127-319-607	RB-36H	151	1-127-320-300	RB-02H	140
RTC1004	RL-13H	197	1-127-319-623	RB-101H	141	1-127-320-301	RB-02H	140
RTC1004	RL-13	197	1-127-319-631	RB-112H	142	1-127-320-303	RB-02H	140
UKC1657	RL-13	197	1-127-319-635	RB-108H	142	1-127-320-304	RB-02H	140
UKC1657	RL-13H	197	1-127-319-637	RB-29H	151	1-127-320-305	RB-02H	140
UKC1662	RL-08HV	197	1127319665	RB-33H	151	1-127-320-306	RB-02H	140
BMW			1-127-319-667	RB-24H	151	1127320307	RB-01HA	140
12311266720	RB-02H	140	1-127-319-694	RB-36H	151	1-127-320-308	RB-02H	140
12311268409	RB-02H	140	1-127-319-710	RB-108H	142	1-127-320-309	RB-02H	140
12311268415	RB-02H	140	1-127-319-715	RB-26H	151	1127320310	RB-01HA	140
12311279597	RB-02H	140	1-127-319-726	RB-37H	151	1127320311	RB-01HA	140
12311288457	RB-55H	153	1127319729	RB-121H	144	1127320312	RB-01HA	140
12311354682	RB-01HA	140	1127319730	RB-121H	144	1-127-320-313	RB-02H	140
12311356060	RB-02H	140	1127319733	RB-107H	142	1127320314	RB-01HA	140
12311358048	RB-02H	140	1127319734	RB-107H	142	1-127-320-316	RB-13H	146
12311363097	RB-02H	140	1127319734	RB-107H	142	1-127-320-317	RB-13H	146
12311706465	RB-02H	140	1127319737	RB-178H	148	1-127-320-318	RB-02H	140
12311715167	RB-54H	153	1127319738	RB-178H	148	1-127-320-319	RB-10H	142
BOMAG			1127319743	RB-33H	151	1-127-320-320	RB-02H	140
5726891	RB-07H	141	1127319744	RB-33H	151	1127320322	RB-01HA	140
5726892	RB-13H	146	1-127-319-749	RB-134H	145	1127320323	RB-01HA	140

CROSS REFERENCE
Voltage Regulator

CROSS REFERENCE
Rectifier

CROSS REFERENCE
Diode Trio

ALTERNATOR NO.
Reg & Rec

**CROSS REFERENCE
Rectifier**

OEM No. → Mobiletron No.

OEM No.	Part No.	Page	OEM No.	Part No.	Page	OEM No.	Part No.	Page
1-127-320-325	RB-02H	140	1-127-320-601	RB-05H	141	1127320740	RB-49H	152
1-127-320-326	RB-02H	140	1-127-320-602	RB-66H	154	1-127-320-741	RB-77H	155
1-127-320-327	RB-11H	144	1-127-320-604	RB-07H	141	1-127-320-743	RB-96H	157
1127320329	RB-01HA	140	1-127-320-608	RB-40H	152	1-127-320-745	RB-54H	153
1-127-320-331	RB-07H	141	1127320609	RB-01HA	140	1-127-320-749	RB-54H	153
1-127-320-336	RB-02H	140	1127320610	RB-01HA	140	1127320750	RB-93H	157
1-127-320-337	RB-07H	141	1127320611	RB-01HA	140	1127320753	RB-93H	157
1127320339	RB-01HA	140	1127320612	RB-01HA	140	1127320807	RB-121H	144
1127320341	RB-01HA	140	1127320613	RB-01HA	140	1-127-320-818	RB-28H	151
1-127-320-342	RB-12H	145	1-127-320-614	RB-03HA	140	1127320844	RB-121H	144
1-127-320-344	RB-08H	141	1-127-320-618	RB-02H	140	1-127-320-850	RB-24H	151
1-127-320-346	RB-02H	140	1-127-320-619	RB-02H	140	1-127-320-852	RB-122H	144
1-127-320-347	RB-02H	140	1-127-320-620	RB-02H	140	1127320854	RB-178H	148
1127320351	RB-01HA	140	1-127-320-622	RB-02H	140	1127320864	RB-121H	144
1127320355	RB-01HA	140	1-127-320-623	RB-02H	140	1-127-320-901	RB-87H	156
1-127-320-356	RB-07H	141	1-127-320-624	RB-02H	140	1-127-320-909	RB-14H	146
1-127-320-358	RB-07H	141	1127320630	RB-01HA	140	1-127-320-910	RB-14H	146
1-127-320-360	RB-43H	152	1-127-320-633	RB-02H	140	1-127-320-911	RB-77H	155
1127320361	RB-73H	155	1-127-320-634	RB-02H	140	1-127-320-912	RB-87H	156
1-127-320-361	RB-72H	154	1127320637	RB-01HA	140	1127320914	RB-18H	150
1-127-320-363	RB-08H	141	1127320641	RB-01HA	140	1-127-320-918	RB-87H	156
1-127-320-364	RB-07H	141	1127320642	RB-01HA	140	1-127-320-920	RB-67HA	154
1-127-320-365	RB-07H	141	1127320644	RB-01HA	140	1-127-320-924	RB-66H	154
1-127-320-366	RB-08H	141	1-127-320-645	RB-02H	140	1127320926	RB-04H	140
1-127-320-367	RB-08H	141	1-127-320-646	RB-02H	140	1127320928	RB-73H	155
1-127-320-368	RB-07H	141	1127320647	RB-01HA	140	1-127-320-928	RB-71H	154
1-127-320-369	RB-42H	152	1-127-320-648	RB-03HA	140	1127320935	RB-49H	152
1-127-320-370	RB-47H	152	1127320649	RB-01HA	140	1-127-320-938	RB-87H	156
1-127-320-372	RB-06HA	141	1-127-320-650	RB-02H	140	1127320945	RB-04H	140
1-127-320-375	RB-07H	141	1-127-320-651	RB-19H	150	1-127-320-946	RB-71H	154
1127320377	RB-01HA	140	1-127-320-652	RB-06HA	141	1-127-320-951	RB-66H	154
1127320378	RB-01HA	140	1127320653	RB-73H	155	1-127-320-954	RB-67H	154
1-127-320-379	RB-72H	154	1-127-320-653	RB-72H	154	1-127-320-955	RB-66H	154
1127320380	RB-01HA	140	1127320654	RB-73H	155	1-127-320-956	RB-71H	154
1127320381	RB-01HA	140	1-127-320-654	RB-72H	154	1127320959	RB-73H	155
1127320382	RB-01HA	140	1127320655	RB-73H	155	1-127-320-959	RB-62H	154
1-127-320-383	RB-02H	140	1-127-320-655	RB-72H	154	1127320960	RB-73H	155
1-127-320-384	RB-02H	140	1127320656	RB-73H	155	1127320961	RB-73H	155
1-127-320-385	RB-02H	140	1-127-320-656	RB-72H	154	1127320961	RB-73H	155
1-127-320-386	RB-72H	154	1-127-320-657	RB-02H	140	1127320969	RB-73H	155
1127320388	RB-73H	155	1127320661	RB-04H	140	1-127-320-969	RB-71H	154
1-127-320-388	RB-72H	154	1-127-320-661	RB-05H	141	1-127-320-970	RB-71H	154
1127320390	RB-73H	155	1127320662	RB-04H	140	1-127-320-971	RB-71H	154
1-127-320-390	RB-62H	154	1-127-320-662	RB-05H	141	1-127-320-973	RB-78H	155
1127320392	RB-01HA	140	1127320664	RB-04H	140	1-127-320-977	RB-63H	154
1127320395	RB-73H	155	1127320665	RB-04H	140	1-127-320-980	RB-66H	154
1-127-320-395	RB-72H	154	1127320666	RB-04H	140	1-127-320-981	RB-66H	154
1-127-320-398	RB-07H	141	1127320667	RB-38H	151	1-127-320-989	RB-71H	154
1-127-320-500	RB-02H	140	1-127-320-668	RB-15H	147	1-127-320-990	RB-71H	154
1-127-320-501	RB-02H	140	1127320669	RB-01HA	140	1127320995	RB-73H	155
1127320502	RB-01HA	140	1-127-320-673	RB-06HA	141	1127321312	RB-01HA	140
1-127-320-506	RB-03HA	140	1-127-320-677	RB-19H	150	1-227-320-116	RB-13H	146
1-127-320-508	RB-02H	140	1-127-320-681	RB-02H	140	1-237-320-345	RB-13H	146
1-127-320-509	RB-02H	140	1-127-320-686	RB-02H	140	30509	RT-06H	226
1-127-320-510	RB-02H	140	1-127-320-691	RB-05H	141	9121067067	RB-84H	156
1-127-320-511	RB-02H	140	1127320692	RB-80H	155	9121067364	RB-84H	156
1127320512	RB-01HA	140	1-127-320-700	RB-51H	153	9121067371	RB-84H	156
1127320513	RB-01HA	140	1-127-320-702	RB-55H	153	9121067374	RB-84H	156
1-127-320-515	RB-46H	152	1-127-320-704	RB-52H	153	9121067375	RB-84H	156
1127320528	RB-01HA	140	1-127-320-705	RB-54H	153	9-121-067-379	RB-81H	156
1-127-320-529	RB-02H	140	1-127-320-706	RB-53H	153	9121067388	RB-84H	156
1127320536	RB-01HA	140	1-127-320-707	RB-57H	153	9121067394	RB-84H	156
1-127-320-538	RB-43H	152	1-127-320-708	RB-56H	153	9-121-080-244	RB-123H	144
1-127-320-540	RB-07H	141	1-127-320-709	RB-55H	153	9-121-080-244	RB-124H	144
1-127-320-541	RB-07H	141	1-127-320-711	RB-60H	154	9-121-080-349	RB-124H	144
1-127-320-543	RB-72H	154	1-127-320-712	RB-58H	153	9-121-080-349	RB-123H	144
1-127-320-545	RB-08H	141	1-127-320-713	RB-59H	154	9-121-080-374	RB-130H	145
1-127-320-546	RB-08H	141	1-127-320-715	RB-54H	153	9-121-080-595	RB-137H	145
1-127-320-547	RB-78HA	155	1127320717	RB-49H	152	9-121-080-595	RB-137HV	145
1-127-320-550	RB-78HA	155	1-127-320-718	RB-75H	155	9-121-080-671	RB-123H	144
1127320554	RB-01HA	140	1-127-320-719	RB-75H	155	9-121-080-671	RB-124H	144
1127320563	RB-01HA	140	1-127-320-720	RB-77H	155	9-121-080-849	RB-124H	144
1-127-320-565	RB-41H	152	1-127-320-721	RB-48H	152	9-121-080-849	RB-123H	144
1-127-320-569	RB-13H	146	1-127-320-722	RB-55H	153	9-121-147-302	RB-17H	148
1-127-320-571	RB-78HA	155	1-127-320-723	RB-54H	153	9-121-337-319	RI-05H	199
1127320572	RB-01HA	140	1-127-320-725	RB-54H	153	9-121-337-321	RI-06H	199
1-127-320-573	RB-02H	140	1127320726	RB-49H	152	9-121-337-323	RI-09H	175
1-127-320-574	RB-02H	140	1-127-320-727	RB-50H	152	9-121-337-324	RI-08H	175
1-127-320-575	RB-02H	140	1-127-320-728	RB-54H	153	9-121-337-325	RI-06H	199
1-127-320-580	RB-06HA	141	1-127-320-730	RB-51H	153	9-121-337-330	RI-06H	199
1-127-320-583	RB-02H	140	1-127-320-731	RB-56H	153	9-121-337-332	RI-06H	199
1-127-320-584	RB-40H	152	1-127-320-732	RB-54H	153	9-121-337-333	RI-06H	199
1-127-320-590	RB-63H	154	1127320734	RB-49H	152	9-121-337-334	RI-06H	199
1-127-320-598	RB-07H	141	1-127-320-735	RB-58H	153	9-121-337-335	RI-06H	199
1-127-320-599	RB-08H	141	1-127-320-739	RB-54H	153	9-121-337-337	RI-07H	175

**CROSS REFERENCE
Rectifier**

OEM No. → Mobiletron No.

OEM No.	Part No.	Page	OEM No.	Part No.	Page	OEM No.	Part No.	Page
9-121-450-310	RB-128H	145	F-00M-599-507	RB-197H	150	1971670	RD-27H	162
9-121-450-310	RB-125H	144	F-00M-599-545	RB-197H	150	1971867	RD-28H	162
9-121-450-311	RB-125H	144	CASE			1971987	RD-09	160
9-121-450-311	RB-128H	145	245537C1	RL-02H	196	1971987	RD-09H	160
9-121-450-533	RB-128H	145	K262267	RL-01H	196	1975313	RD-31H	162
9-121-450-533	RB-125H	144	CATERPILLAR			1975313	RD-14H	160
9-122-067-305	RB-80HA	155	9L6776	RD-17H	161	1975313	RD-31	162
9-122-080-638	RB-138H	145	CHRYSLER			1975313	RD-14	160
9-122-080-676	RB-148H	146	138893	RM-53HV	217	1975645	RD-17H	161
9-122-080-923	RB-145H	146	3438721	RC-21N	158	1984454	RD-12	160
9-127-041-132	RB-14H	146	3438727	RC-21P	158	1984638	RD-09	160
9-127-041-133	RB-14H	146	3755114	RC-21N	158	1984638	RD-09H	160
9-128-040-953J	RB-85H	156	3874268	RC-21P	158	1985801	RD-15H	161
9-128-041-566	RB-141H	146	3874269	RC-21P	158	1985801	RD-15	161
F-000-BL9-043	RB-187H	149	3874343	RC-21P	158	1987061	RD-13HV	160
F-000-LD1-006	RB-146H	146	4026082	RC-21P	158	1988976	RD-05	159
F-000-LD1-012	RB-158H	146	4026083	RC-21P	158	1989658	RD-95A	164
F-00M-113-200	RB-118H	143	4026282	RC-21P	158	1989658	RD-96	164
F-00M-113-219	RB-190H	150	4240488	RC-21P	158	1989774	RD-06A	159
F-00M-123-201	RB-116H	143	4364855	RC-19	158	233195	RD-30	162
F00M123202	RB-115H	143	4467162	RC-19	158	3472020	RD-29	162
F-00M-123-204	RB-113H	143	5226009	RC-19	158	3472311	RD-10	160
F-00M-123-217	RB-113H	143	CITROEN			3472311	RD-10H	160
F-00M-123-226	RB-926H	156	5744C9	RP-13	231	3472813	RD-18H	161
F-00M-123-228	RB-172H	148	9405144528	RB-02H	140	3472813	RD-18HA	161
F-00M-123-229	RB-926H	156	95644506	RP-13	231	3472820	RD-21	161
F-00M-123-238	RB-172H	148	CLAAS			3472820	RD-21H	162
F-00M-123-249	RB-172H	148	1326530	RB-07H	141	3472820	RD-29	162
F-00M-123-251	RB-188H	149	DAEWOO			3478627	RD-21H	162
F-00M-123-265	RB-167HV	147	262100	RD-16	159	3478627	RD-21	161
F-00M-123-266	RB-179HV	148	267000	RD-16	159	3478687	RD-21	161
F-00M-123-268	RB-188H	149	276000	RD-16	159	3478687	RD-21H	162
F-00M-123-270	RB-194H	150	DAF			3478687	RD-29	162
F-00M-123-280	RB-188H	149	132114	RB-93H	157	3493008	RD-20HA	161
F-00M-123-323	RB-172H	148	692060	RB-02H	140	3493417	RD-20HA	161
F00M123337	RB-115H	143	694065	RB-08H	141	3493714	RD-18HA	161
F00M133201	RB-119H	143	694461	RB-02H	140	3493714	RD-18H	161
F-00M-133-202	RB-171HV	148	DELCO			3493716	RD-20HA	161
F00M133204	RB-929H	156	10456401	RD-96	164	3493717	RD-20HA	161
F00M133204	RB-166H	147	10457236	RD-96	164	3493721	RD-18HA	161
F-00M-133-206	RB-163H	147	10457690	RD-96	164	3493721	RD-18H	161
F00M133214	RB-166H	147	10467052	RD-06A	159	589714	RD-04B	159
F00M133214	RB-929H	156	10469265	RD-06	159	6065301	RD-18H	161
F00M133215	RB-166H	147	10470609	RD-06A	159	6065301	RD-18HA	161
F00M133215	RB-929H	156	10470730	RD-96	164	7332312	RD-10HV	160
F-00M-133-215	RB-929HV	156	10471170	RD-06A	159	7982716	RD-10	160
F00M133218	RB-166H	147	10472095	RD-08	159	7982716	RD-10H	160
F00M133218	RB-929H	156	10472597	RD-96	164	7982718	RD-10H	160
F-00M-133-218	RB-929HV	156	10475034	RD-04B	159	7982718	RD-10	160
F-00M-133-224	RB-117H	143	10475034	RD-04B	159	801816	RD-17H	161
F-00M-133-225	RB-180HV	149	10475758	RD-99	164	801816	RD-17	161
F00M133226	RB-168H	147	10475758	RD-97HV	164	90140931	RB-02H	140
F00M133228	RB-119H	143	10475758	RD-97A	164	90272286	RB-02H	140
F00M133229	RB-166H	147	10475800	RD-07	159	A3900	RF-08H	177
F00M133229	RB-929H	156	10491097	RD-99	164	A3900	RF-08HV	177
F-00M-133-229	RB-929HV	156	10491097	RD-97D	164	CS130D	RD-97A	164
F-00M-133-230	RB-163H	147	10492300	RD-25A	162	D3915	RD-09	160
F00M133244	RB-119H	143	10492837	RD-97D	164	D3915	RD-09H	160
F00M133246	RB-119H	143	10492838	RD-97D	164	D3919	RD-31H	162
F00M133247	RB-166H	147	10492838	RD-99	164	D3919	RD-14H	160
F00M133247	RB-929H	156	10493596	RD-29	162	D3919	RD-31	162
F-00M-133-247	RB-929HV	156	10494503	RD-26HD	162	D3919	RD-14	160
F-00M-133-248	RB-163H	147	10494744	RD-26	162	D3924	RD-12	160
F00M133249	RB-166H	147	10501635	RD-35A	163	D3929	RD-06	159
F00M133249	RB-929H	156	10503581	RD-40HA	163	D3931	RD-06A	159
F00M133259	RB-929H	156	10503581	RD-40H	163	D3982	RD-17	161
F-00M-133-259	RB-929HV	156	10510904	RD-40H	163	D3982	RD-17H	161
F-00M-133-265	RB-175HD	148	10510904	RD-40HA	163	D3983	RD-17H	161
F-00M-133-267	RB-174HD	148	10511353	RD-35	163	D3983	RD-17	161
F-00M-133-269	RB-952H	157	10512366	RD-35A	163	D3985	RD-15	161
F-00M-133-274	RB-181HD	149	10512371	RD-36	163	D3985	RD-15H	161
F00M133276	RB-166H	147	1205464	RD-04B	159	D3986	RD-13HV	160
F-00M-133-277	RB-954H	157	1851437	RD-27H	162	D3987	RD-05	159
F-00M-133-278	RB-175HD	148	1852209	RD-09H	160	D3990	RD-06A	159
F-00M-133-292	RB-181HD	149	1852209	RD-09	160	D3991	RD-95A	164
F-00M-133-311	RB-174HD	148	1875627	RD-09	160	D3991	RD-96	164
F-00M-133-312	RB-175HD	148	1875627	RD-09H	160	D3992	RD-06A	159
F-00M-133-313	RB-175HD	148	1875645	RD-17H	161	DR1000	RD-10	160
F00M133351	RB-119H	143	1875645	RD-17	161	DR3900	RD-10H	160
F00M133363	RB-119H	143	1891055	RD-09H	160	DELCO REMY (LUCAS)		
F00M133369	RB-168H	147	1891055	RD-09	160	21221403	RB-02H	140
F00M133372	RB-168H	147	1892914	RD-17H	161	21221418	RB-04H	140
F-00M-256-202	RB-170HD	148	1892914	RD-17	161	21221419	RB-06HA	141
F-00M-599-451	RB-195H	150	19055072	RD-33	163	21222124	RI-02HA	199
F-00M-599-451	RB-196H	150	1969132	RD-27H	162	21225379	RP-09	230

CROSS REFERENCE
Voltage Regulator

CROSS REFERENCE
Rectifier

CROSS REFERENCE
Diode Trio

ALTERNATOR NO.
Reg & Rec

**CROSS REFERENCE
Rectifier**

OEM No. → Mobiletron No.

OEM No.	Part No.	Page	OEM No.	Part No.	Page	OEM No.	Part No.	Page
21225386	RP-01	229	021600-1491	RN-22	168	9939571	RB-02H	140
21225400	RP-04	229	021600-1491	RN-20	168	9939575	RB-52H	153
DENSO			021600-1531	RN-20	168	9941113	RB-02H	140
012580-4510	RN-03PL	165	021600-1531	RN-22	168	9941712	RB-51H	153
012580-4760	RN-03PL	165	021600-1561	RN-22	168	9942883	RB-51H	153
021580-06510	RN-36	169	021600-1561	RN-20	168	9947325	RI-01HA	199
021580-2160	RN-13PL	166	021600-1610	RN-32	169	9947325	RI-02HA	199
021580-2160	RN-13	166	021600-1840	RN-31	169	9950067	RB-52H	153
021580-2230	RN-13	166	0260002432	RT-06H	226	9950095	RB-01HA	140
021580-2230	RN-13PL	166	0260002540	RT-06H	226	9950118	RB-51H	153
021580-2250	RN-16PL	167	0260002680	RT-06H	226	9950193	RB-51H	153
021580-2250	RN-16	167	0260002720	RT-06H	226	9957574	RB-10H	142
021580-2260	RN-16	167	0260003190	RT-06H	226	9957575	RB-10H	142
021580-2260	RN-16PL	167	0260003230	RT-06H	226	9959902	RB-10H	142
021580-2340	RN-17	167	0260003330	RT-06H	226	9960115	RB-02H	140
021580-2341	RN-17	167	0260003350	RT-06H	226	FORD		
021580-2342	RN-17	167	0260003510	RT-06H	226	139668	RF-063	176
021580-2510	RN-12	166	0260003560	RT-06H	226	1477517	RB-01HA	140
021580-2511	RN-12	166	0260003570	RT-06H	226	1477518	RB-11H	144
021580-2512	RN-12	166	0260003700	RT-06H	226	1632835	RB-51H	153
021580-2521	RN-12	166	0260003860	RT-06H	226	233208	RF-113	177
021580-2522	RN-12	166	0260003861	RT-06H	226	6017534	RB-01HA	140
021580-3080	RN-40	170	0260003880	RT-06H	226	6033077	RB-01HA	140
021580-3110	RN-18	168	0260003980	RT-06H	226	6041730	RB-01HA	140
021580-3130	RN-15	167	03726	RN-54	171	6088149	RB-06HA	141
021580-3130	RN-15PL	167	100211-1830	RN-19	168	6094903	RB-08H	141
021580-3340	RN-15	167	100211-2840	RN-19	168	613319	RB-72H	154
021580-3450	RN-26	168	101211-1250	RN-40	170	6153349	RB-57H	153
021580-3640	RN-14	167	7060	RN-34	169	6153350	RB-53H	153
021580-3640	RN-01	165	785	RN-59	172	6154904	RB-01HA	140
021580-3660	RN-03PL	165	ECHLIN			6156187	RB-38H	151
021580-3680	RN-01	165	AC82	RM-15	208	692F-10304AA	RL-12H	197
021580-3680	RN-14	167	FAUN			69EB-10304AA	RL-08HV	197
021580-3750	RN-11	166	4791517	RB-08H	141	71BB-10304AA	RB-11H	144
021580-3830	RN-03	165	FEMSA			71BB-10304BA	RB-01HA	140
021580-3830	RN-03PL	165	19326-1	RI-04H	199	72GB-10304AA	RB-01HA	140
021580-3890	RN-26	168	25945-1	RI-05H	199	74EB-10304AA	RB-01HA	140
021580-3990	RN-11	166	25945-10	RI-06H	199	75AB-10304AA	RL-15	198
021580-4030	RN-03PL	165	25945-17	RI-06H	199	75AB-10304AA	RL-15H	198
021580-4040	RN-11	166	25945-20	RI-06H	199	75BB-10304AA	RB-01HA	140
021580-4080	RN-03	165	25945-21	RI-06H	199	75EB-10304AA	RB-01HA	140
021580-4080	RN-03PL	165	25945-25	RI-06H	199	78GB-10304AA	RB-42H	152
021580-4100	RN-11	166	25945-27	RI-06H	199	81AB-10304AA	RL-02H	196
021580-4110	RN-11	166	25945-3	RI-06H	199	81AB-10304BA	RL-04H	196
021580-4120	RN-14	167	25945-8	RI-09H	175	81AB-10304CA	RL-04H	196
021580-4120	RN-01	165	25945-9	RI-08H	175	81AB-10304DA	RB-06HA	141
021580-4250	RN-10	166	28466-6	RI-07H	175	81DB-10304BA	RL-02H	196
021580-4310	RN-15	167	FIAT			81DB-10304CA	RB-06HA	141
021580-4340	RN-15	167	4149607	RI-04H	199	82BB-10304AA	RL-02H	196
021580-4430	RN-11	166	4149609	RI-04H	199	82DB-10304BA	RB-08H	141
021580-4480	RN-03	165	4175054	RI-04H	199	83DB-10304AA	RB-72H	154
021580-4480	RN-03PL	165	4474546	RI-05H	199	85GB-10304CA	RB-53H	153
021580-4490	RN-14	167	4474564	RB-10H	142	85GB-1034BA	RB-57H	153
021580-4590	RN-10	166	60725868	RB-02H	140	864F-10304AA	RL-06H	196
021580-4610	RN-11	166	60736000	RB-02H	140	86AB10304AA	RB-38H	151
021580-4630	RN-03	165	60749249	RB-01HA	140	86AB-10304BA	RL-09H	197
021580-4630	RN-03PL	165	60754984	RB-02H	140	86GB-10304CA	RB-53H	153
021580-4660	RB-01	165	60755038	RB-01HA	140	87BB-10304CA	RL-21H	198
021580-4690	RN-11	166	60777846	RB-01HA	140	D2OZ-10304A	RF-09H	177
021580-4780	RN-51	171	79022471	RB-02H	140	D2OZ-10304A	RF-09HV	177
021580-4820	RN-02	165	79031725	RB-02H	140	D3VY-10304A	RF-16HD	178
021580-4840	RB-01	165	79078926	RB-02H	140	D3VY-10304A	RF-16HV	178
021580-4850	RN-04	165	8223891	RB-11H	144	D4NN-10304A	RL-08HV	197
021580-4890	RN-49	171	82273891	RB-11H	144	D6AZ10304A	RF-07H	177
021580-5040	RN-11	166	82327406	RB-02H	140	D6AZ-10304A	RF-08HV	177
021580-5060	RN-12	166	82335792	RB-02H	140	D6AZ-10304A	RF-08H	177
021580-5160	RN-03PL	165	929167	RB-10H	142	D9VY10304A	RF-07H	177
021580-5300	RN-38	169	9921409	RB-11H	144	D9VY-10304A	RF-08H	177
021580-5510	RN-36	169	9923275	RB-11H	144	E3NN-10304AA	RL-02H	196
021580-5560	RN-36	169	9924967	RB-11H	144	E43Z-10304A	RF-23W	179
021580-5810	RN-03PL	165	9927730	RB-11H	144	E43Z-10304A	RF-01	176
021580-5920	RN-44	170	9927838	RB-02H	140	E43Z-10335A	RF-01	176
021580-5941	RN-57	172	9928604	RB-10H	142	E5RD10304AA	RB-51H	153
021580-6490	RN-48	171	9934237	RB-02H	140	E6DZ10304	RF-23W	179
021580-6490	RN-48M	171	9934595	RI-01HA	199	E6DZ-10304	RF-02	176
021580-6610	RN-46M	170	9934639	RB-02H	140	E6DZ-10304A	RF-02	176
021580-6610	RN-46	170	9934756	RB-10H	142	E6DZ-10304A	RF-23W	179
021590-1890	RN-41	170	9934958	RI-01HA	199	E7GY-10304A	RM-02HV	204
021590-1900	RN-41	170	9935804	RL-16	198	E7GZ-10304A	RM-15	208
021590-1910	RN-41	170	9936080	RB-01HA	140	E7NN-10304AA	RL-01H	196
021590-1950	RN-41	170	9936539	RB-02H	140	E8GY-10304B	RM-10HV	205
021590-1990	RN-50L	171	9936608	RB-02H	140	E8PZ-10301B	RM-29HV	215
021590-2050	RN-50L	171	9937233	RB-02H	140	E8PZ-10304A	RM-30	215
021600-0750	RN-32	169	9937250	RL-02H	196	E92Z-10304A	RM-10HV	205
021600-1420	RN-32	169	9937529	RB-02H	140	E98Z-10304A	RM-08HV	205

**CROSS REFERENCE
Rectifier**

OEM No. → Mobiletron No.

OEM No.	Part No.	Page	OEM No.	Part No.	Page	OEM No.	Part No.	Page
E9DZ-10304A	RF-16HV	178	L150-83202	RH-04N	181	16903507	RK-01	194
E9DZ-10304A	RF-16HD	178	L150-83202	RH-04	181	16905321	RT-06H	226
E9PZ10304B	RM-43	216	L150N-13202	RH-51	187	16906614	RT-19H	233
E9PZ-10304B	RM-41	216	L160-13201	RH-49	187	ISUZU		
E9YJ-10304A	RB-82H	156	L160-13202	RH-04	181	16231-64851	RN-17	167
F0HZ-10304A	RF-16HD	178	L160-13202	RH-04N	181	1-81270001-0	RT-06H	226
F0HZ-10304A	RF-16HV	178	L160-13203	RH-04N	181	5-81200-084-0	RH-49	187
F0TZ-10304A	RF-09HV	177	L160-23201	RH-14C	183	5-81200-114-0	RH-49	187
F32Z-10304A	RM-59	218	L160-23202	RH-15C	183	5-81218-001-0	RH-49	187
F32Z-10304A	RM-59HV	218	L160-23202	RH-15	183	5-81218-021-0	RH-49	187
F5AZ-10304AA	RF-053	176	L160-3320	RH-01	180	5-81218-022-0	RH-49	187
F5AZ-10304AA	RF-053HV	176	L160-3320	RH-12C	183	5-81218-029-0	RH-16C	184
F5AZ-10304BA	RF-043	176	L160-3320	RH-11C	182	5-81262-006-0	RH-03	180
F5OZ-10300FA	RF-063	176	L160-3320	RH-01C	180	5-81262-006-0	RH-03C	180
F6DU-10300BB	RF-063	176	L160-33201	RH-59C	188	5-81262-006-0	RH-10C	182
F6LU-10300CA	RF-063	176	L160-33202	RH-08C	181	8-42213-40	RH-20C	184
F6OU-10300AA	RF-063	176	L160-4320	RH-04	181	8-94116-432-0	RH-14C	183
F6ZU-10300BB	RF-063	176	L160-4320	RH-04N	181	8-94125884-0	RN-12	166
F8AU10A366AA	RF-123	178	L160-4320	RH-04C	181	8-94167-411-0	RH-04N	181
F8AU10A366AIP	RF-123	178	L160-43202	RH-15	183	8-94167-411-0	RH-04	181
F8AU-10A366AIP	RF-123HV	178	L160-43202	RH-15C	183	8-94167-411-0	RH-04C	181
F8WU10A336AA1P	RF-103	177	L160-53202	RH-04N	181	8-94206-081-0	RH-49	187
F8WU10A366AA	RF-103	177	L160-53202	RH-04	181	8-94237-729-0	RH-02C	180
F8WU10A366AIP	RF-103	177	L160-6320	RH-03	180	8-94237-729-0	RH-02	180
F8WU-10A366AIP	RF-103HV	177	L160-7320	RH-04	181	8-94246-957-1	RH-17C	184
FODU-10A366DAIP	RF-053	176	L160-7320	RH-04N	181	8-97062651-0	RH-58C	188
GY-1026-A	RF-09HV	177	L160-73202	RH-08C	181	9-82231-619-0	RH-49	187
GY1306A	RF-07H	177	L160-9320	RH-03	180	IVECO		
GY1351	RF-23W	179	L160-93201	RH-04	181	42531816	RB-93H	157
GY1360	RF-23W	179	L160-93201	RH-04N	181	79078926	RB-02H	140
GYE1379	RM-30	215	L160G-53201	RH-65	188	8122274	RB-78HA	155
GM			L165-6320	RH-40C	187	93160252	RB-71H	154
90349909	RB-19H	150	L165-7320	RH-40C	187	93163820	RB-78H	155
90350009	RB-18H	150	L170-23203	RH-24	185	JOHN DEERE		
90350013	RB-38H	151	L170-33202	RH-21	184	AL27374	RB-13H	146
HANOMAG			L170-43202	RH-22	184	AL30419	RB-07H	141
582901738	RB-11H	144	L170-5320	RH-04N	181	AZ24486	RB-13H	146
HITACHI			L170-5320	RH-04	181	AZ31708	RB-07H	141
234829	RH-82	189	L170-7302	RH-40C	187	KHD		
L1100G-23201	RH-71	189	L170-9320	RH-39C	186	1318310	RB-71H	154
L1100G-23201	RH-77	189	L170-93202	RH-27C	185	1319100	RB-78H	155
L1100G-3340	RV-H040	192	L170-93202	RH-27	185	1320547	RB-78HA	155
L1100G-5320	RH-61	188	L170G-1320	RH-26	185	KIA		
L1100G-6320	RH-77	189	L170G-2320	RH-25	185	KK137-24-W60	RM-119H	206
L1100G-9340	RV-H040	192	L170G-3319	RH-48	187	KLOCKNER-HUMBOL-DEUTZ		
L1110G-23201	RH-77	189	L170G-3319	RH-72	189	1304898	RB-07H	141
L1110G-4320	RH-35	186	L170G-3320	RH-22	184	1306533	RB-13H	146
L1110G-6320	RH-77	189	L170G-6320	RH-22	184	1308400	RB-08H	141
L1110G-73082	RH-77	189	L170G-63201	RH-04N	181	1308450	RB-07H	141
L1110G-8320	RH-77	189	L170G-73201	RH-27	185	1308783	RB-07H	141
L1125G-2320	RH-35	186	L170G-73201	RH-27C	185	1309115	RB-07H	141
L125-6320	RH-49	187	L170G-73202	RH-53C	188	1318566	RB-04H	140
L125-8320	RH-49	187	L170G-8320	RH-27C	185	42485735	RB-07H	141
L135-13208	RH-18C	184	L170G-8320	RH-27	185	42486339	RB-07H	141
L135-3320	RH-20C	184	L180-13202	RH-23	184	42487053	RB-08H	141
L135N-13201	RH-51	187	L180G-1320	RH-22	184	42487911	RB-07H	141
L140-13202	RH-04	181	L180G-7320	RH-29	185	42487948	RB-02H	140
L140-13202	RH-04N	181	L180G-8320	RH-58C	188	8121110	RB-02H	140
L140-13202	RH-04C	181	L190-1320	RH-43C	187	9941262	RB-13H	146
L140-23201	RH-16C	184	L190-3320	RH-43C	187	LAMBORGHINI		
L140-53201	RH-17C	184	L190-5320	RH-43C	187	294390706	RB-13H	146
L140-53202	RH-04	181	L190G-33201	RH-60	188	294391002	RB-13H	146
L140-53202	RH-04N	181	L190G-33204	RH-75	189	LANCIA		
L140-53202	RH-04C	181	L190G-33204	RH-33	186	82302915	RB-02H	140
L140-6320	RH-49	187	L190G-63205	RH-33	186	82302916	RB-02H	140
L140-7320	RH-49	187	L225-4320	RH-04	181	LEECE NEVILLE		
L140-9320	RH-49	187	L225-4320	RH-04N	181	101387	RC-01HV	195
L140-93202	RH-03	180	L225-6320	RH-04N	181	101411	RC-02HV	195
L150-13202	RH-09C	181	L225-6320	RH-04	181	101441	RC-02HV	195
L150-13203	RH-11C	182	L250-83081	RV-H053B	192	71180	RC-03H	195
L150-13203	RH-01C	180	HONDA			71181	RC-04H	195
L150-13203	RH-12C	183	31127-PE0-0340	RM-15	208	79193	RC-05HV	195
L150-13203	RH-01	180	31127-PGM-004	RM-154HV	209	79415	RC-06HV	195
L150-13204	RH-02	180	31127-PT0-003	RN-03PL	165	97084	RC-07HV	195
L150-13204	RH-02C	180	31127-PY3-0030	RN-10	166	97085	RC-08HV	195
L150-13206	RH-03C	180	IHC			A051101387	RC-01HV	195
L150-13206	RH-03	180	3078594R91	RB-01HA	140	A051101441	RC-02HV	195
L150-13206	RH-10C	182	3078957R91	RB-13H	146	LUCAS		
L150-43203	RH-04	181	3078957R92	RB-13H	146	21221418	RB-04H	140
L150-43203	RH-04N	181	3079133R91	RB-02H	140	21221435	RB-43H	152
L150-73203	RH-03	180	3079133R92	RB-02H	140	21223056	RI-05H	199
L150-83201	RH-04	181	3079385R91	RB-07H	141	21223062	RI-05H	199
L150-83201	RH-04N	181	3079411R91	RB-07H	141	21229191	RT-06H	226
L150-83201	RH-04C	181	ISKRA			21229192	RT-05H	226
L150-83202	RH-04C	181	16903314	RK-02	194	21229193	RT-07H	227

CROSS REFERENCE
Voltage Regulator

CROSS REFERENCE
Rectifier

CROSS REFERENCE
Diode Trio

ALTERNATOR NO.
Reg & Rec

**CROSS REFERENCE
Rectifier**

OEM No. → Mobiletron No.

OEM No.	Part No.	Page	OEM No.	Part No.	Page	OEM No.	Part No.	Page
21229194	RT-08H	227	84572010	RL-21H	198	UBB513	RT-05H	226
21229200	RT-01H	226	84574	RL-22H	198	UBB600	RI-07H	175
21229202	RT-21H	227	84602	RL-16	198	UBB601	RI-05H	199
21229203	RT-09H	227	84717	RL-15	198	UBB602	RI-06H	199
21229204	RT-03H	226	84717	RL-15H	198	UBJ102	RH-49	187
21229218	RT-05H	226	84718	RL-14H	198	UBJ105	RH-50	187
2131030	RB-38H	151	84718	RL-14	198	UBJ200	RM-15	208
21511112	RH-50	187	84719	RL-02H	196	UBJ208	RM-75	220
21511119	RH-51	187	84720	RL-04H	196	UBJ219	RM-68	219
21511121	RM-76	220	84758	RL-02H	196	UBJ220	RM-76	220
21511122	RM-85	221	84759	RL-02H	196	UBJ256	RM-65	219
21511124	RM-60	218	84760	RL-03H	196	UBJ257	RM-66	219
21511125	RH-49	187	84761	RL-03H	196	UBJ302	RM-73	220
21513100	RM-68	219	84765	RL-05H	196	MAGIRUS-DEUTZ		
21513102	RM-75	220	84767	RL-04H	196	1309660	RB-78HA	155
21513105	RM-73	220	84855	RL-01H	196	8128110	RB-02H	140
21513107	RM-66	219	84885	RL-01H	196	8197578	RB-08H	141
21513128	RM-74	220	84885010	RL-01H	196	8198257	RB-08H	141
21513129	RM-15	208	84886	RL-09H	197	8198792	RB-02H	140
21513130	RM-65	219	84886	RL-09H	197	MAGNETI MARELLI		
21513134	RM-67	219	84886010	RL-09H	197	000000028502	RL-09H	197
28500010	RL-10H	197	84888	RL-07H	196	000000084469	RL-09H	197
28506010	RL-10H	197	84889	RL-01H	196	000000084886	RL-09H	197
35213274	RL-23H	198	84976	RL-10H	197	000028502010	RL-09H	197
60211170	RL-20H	198	UBB108	RL-12H	197	000084469010	RL-09H	197
66201570	RL-01H	196	UBB109(4D45)	RL-08HV	197	00084574	RI-16H	200
80150	RL-09H	197	UBB110(4DS7)	RL-08HV	197	233534	RI-31H	201
80367	RL-09H	197	UBB111	RL-13H	197	28500	RL-10H	197
83062	RL-12H	197	UBB111	RL-13	197	28502	RL-09H	197
83166(4DS5)	RL-08HV	197	UBB112	RL-20H	198	28506	RL-10H	197
83178	RL-12H	197	UBB113	RL-14	198	5402243B	RI-15H	200
83192	RL-12H	197	UBB113	RL-14H	198	54209741	RI-16H	200
83295	RL-13	197	UBB115	RL-02H	196	63022101	RI-12H	200
83295	RL-13H	197	UBB116	RL-04H	196	63321239	RI-26H	201
83320	RL-20H	198	UBB117	RL-03H	196	63328506	RL-10H	197
83334(4DS8)	RL-08HV	197	UBB118	RL-05H	196	63621501	RI-02HA	199
83442	RL-14	198	UBB120	RL-03H	196	63621601	RI-02HA	199
83442	RL-14H	198	UBB121	RL-04H	196	63622001	RI-11H	199
83452	RL-15H	198	UBB122	RL-02H	196	63622201	RI-13H	200
83452	RL-15	198	UBB124	RL-03H	196	63623501	RI-21H	200
83520	RL-08HV	197	UBB126	RL-05H	196	63623601	RI-17H	200
83563	RL-02H	196	UBB127	RL-04H	196	63623602	RI-18H	200
83565	RL-03H	196	UBB128	RL-16	198	63623701	RI-19H	200
83567	RL-04H	196	UBB129	RL-02H	196	63623801	RI-22H	200
83569	RL-05H	196	UBB130	RL-15	198	63624103	RI-31H	201
83571	RL-05H	196	UBB130	RL-15H	198	63624201	RI-23HD	200
83584	RL-16	198	UBB131	RL-17H	198	63624201	RI-23H	200
83623	RL-04H	196	UBB133	RL-01H	196	63624202	RI-24H	201
83633	RL-14H	198	UBB135	RL-01H	196	63624701	RI-21H	200
83633	RL-14	198	UBB136	RL-11H	197	63624801	RI-21H	200
83634	RL-15	198	UBB137	RL-09H	197	63624802	RI-25	201
83634	RL-15H	198	UBB137	RL-09H	197	63625002	RI-35	201
83642	RL-02H	196	UBB138	RL-22H	198	63633801	RI-14H	200
83643	RL-02H	196	UBB140	RL-06H	196	64826011	RI-01HA	199
83645	RL-04H	196	UBB141	RL-01H	196	64826022	RI-01HA	199
83670	RL-03H	196	UBB143	RL-01H	196	64826040	RI-01HA	199
83757	RL-03H	196	UBB144	RL-01H	196	64877471	RI-01HA	199
83763	RL-17H	198	UBB145	RL-21H	198	64878691	RI-01HA	199
83784	RL-03H	196	UBB147	RL-07H	196	74877471	RI-01HA	199
83842(4DS7)	RL-08HV	197	UBB232	RP-01	229	74878691	RI-01HA	199
83844	RL-08HV	197	UBB233	RP-04H	229	74953001	RI-04H	199
83962	RL-12H	197	UBB235	RP-02	229	74965501	RI-05H	199
84124	RL-13	197	UBB237	RP-07	230	74966611	RI-05H	199
84124	RL-13H	197	UBB238	RP-08	230	74966621	RI-05H	199
84125	RL-12H	197	UBB250	RP-14	231	74986411	RB-10H	142
84201	RL-01H	196	UBB251	RP-14	231	74990331	RI-04H	199
84422	RL-01H	196	UBB252	RP-17	232	74990341	RI-04H	199
84443	RL-08HV	197	UBB253	RP-14	231	74995001	RB-10H	142
84454	RL-01H	196	UBB254	RP-13	231	74995801	RB-10H	142
84454010	RL-01H	196	UBB256	RP-20	232	74999091	RI-04H	199
84455	RL-01H	196	UBB411	RB-01HA	140	84454	RL-01H	196
84456	RL-06H	196	UBB420	RB-04H	140	85552103	RI-35	201
84456010	RL-06H	196	UBB429	RB-38H	151	85552104	RI-35	201
84457	RL-01H	196	UBB432	RB-56H	153	85552105	RI-35	201
84459	RL-13	197	UBB433	RB-54H	153	85552106	RI-35	201
84459	RL-13H	197	UBB434	RB-72H	154	85552107	RI-35	201
84460	RL-12H	197	UBB502	RT-10H	227	85552108	RI-35	201
84468	RL-11H	197	UBB503	RT-07H	227	85552109	RI-35	201
84469	RL-09H	197	UBB505	RT-06H	226	85552110	RI-35	201
84469	RL-09H	197	UBB506	RT-05H	226	940038202	RB-10H	142
84469010	RL-09H	197	UBB507	RT-08H	227	940038206	RB-56H	153
84486	RL-06H	196	UBB508	RT-03H	226	940038208	RB-54H	153
84499	RL-01H	196	UBB509	RT-01H	226	940038210	RB-38H	151
84499010	RL-01H	196	UBB511	RT-21H	227	940038237	RI-06H	199
84572	RL-21H	198	UBB512	RT-09H	227	940038246	RM-75	220

**CROSS REFERENCE
Rectifier**

OEM No. → Mobiletron No.

OEM No.	Part No.	Page	OEM No.	Part No.	Page	OEM No.	Part No.	Page
940038247	RM-68	219	F811-18-W60	RM-08HV	205	A860T06370	RM-71	220
940038249	RH-51	187	F825-18-W60	RM-31	215	A860T06470	RM-105	205
940038255	RM-15	208	F881-18-W60	RM-01HV	204	A860T06470	RM-66	219
940038256	RM-76	220	F8B1-18-W60	RM-10HV	205	A860T06870	RM-94	222
940038257	RM-65	219	FE01-24-510A	RM-83	221	A860T07170	RM-63	219
940038261	RL-20H	198	FE05-24-510	RM-74	220	A860T07270	RM-69	220
940038281	RT-07H	227	FE65-18-W60	RM-02HV	204	A860T07370	RM-75	220
940038282	RT-05H	226	FE65-18-W60A	RM-02HV	204	A860T07770	RM-75	220
940038283	RT-06H	226	FE65-18-W60A	RM-15	208	A860T08270	RM-65	219
940038284	RT-08H	227	FE65-24-510	RM-15	208	A860T08370	RM-83	221
940038286	RT-09H	227	FE65-24-510	RM-01HV	204	A860T08470	RM-85	221
940038287	RT-02H	226	FE65-24-510	RM-01HV	204	A860T08570	RM-78	221
940038288	RT-12H	227	FE79-18-W60	RM-08HV	205	A860T08770	RM-73	220
940038289	RT-03H	226	FS11-18-W60	RM-59	218	A860T10370	RM-74	220
940038290	RT-01H	226	FS11-18-W60	RM-59HV	218	A860T10470	RM-83	221
940038292	RT-07H	227	GE01-24-510	RM-63	219	A860T10770	RM-67	219
940038293	RT-10H	227	HE41-24-510	RM-83	221	A860T11070	RM-60	218
940038315	RP-14	231	JE15-18-W60	RM-31	215	A860T11270	RM-62	219
940038316	RP-17	232	JE48-18-W60B	RM-45	217	A860T11370	RM-74	220
940038326	RP-14	231	K801-18-W60	RM-46	217	A860T11770	RM-76	220
PRD4A	RI-01HA	199	N221-24-510	RM-66	219	A860T11970	RM-01HV	204
RDD15	RI-02HA	199	N3A1-18-W60	RM-46	217	A860T11970	RM-15	208
RDD16	RI-02HA	199	S205-24-510	RM-78	221	A860T12870	RM-84	221
RDD22	RI-13H	200	S215-24-510	RM-73	220	A860T13070	RM-06	204
RDD33	RI-14H	200	MEC(OLD)			A860T13170	RM-07HV	205
RDD346455	RI-12H	200	RB-126H	RB-926H	156	A860T13370	RM-01HV	204
RDD35	RI-21H	200	RB-129H	RB-929H	156	A860T13370	RM-15	208
RDD65	RI-21H	200	RB-129HV	RB-929HV	156	A860T13870	RM-06	204
RDD75	RI-21H	200	RB-152H	RB-952H	157	A860T14570	RM-86	222
RDD75	RI-25	201	RB-154H	RB-954H	157	A860T15170	RM-73	220
MAGNETON-PAL			MERCEDES-BENZ			A860T16770	RM-04HV	204
0135940	RK-03	202	0001545116	RB-78HA	155	A860T16970	RM-07HV	205
0135941	RK-03	202	0001545416	RB-78HA	155	A860T17170	RM-06	204
0140880	RK-03	202	0005481416	RB-93H	157	A860T17270	RM-09HV	205
0140881	RK-03	202	0011540816	RB-78H	155	A860T17285	RM-09HV	205
443930135940	RK-03	202	0011542216	RB-93H	157	A860T17470	RM-02HV	204
MAN			1541216	RB-11H	144	A860T17470	RM-15	208
81261090001	RB-07H	141	1541316	RB-01HA	140	A860T17570	RM-08HV	205
81261090004	RB-07H	141	1541416	RB-01HA	140	A860T17770	RM-11	205
81261090005	RB-07H	141	1542016	RB-01HA	140	A860T17870	RM-02HV	204
81261090014	RB-04H	140	1542016	RB-07H	141	A860T17870	RM-15	208
81261090016	RB-66H	154	1542116	RB-07H	141	A860T17970	RM-08HV	205
81261090018	RB-71H	154	1542316	RB-07H	141	A860T18870	RM-81	221
MANDO			1542416	RB-08H	141	A860T18899	RM-81	221
TA600C13301	RM-132	203	1542516	RB-08H	141	A860T19370	RM-18	210
MASSEY FERGUSON			1542716	RB-08H	141	A860T19870	RM-15	208
1429443M1	RL-08HV	197	1542916	RB-01HA	140	A860T20270	RM-12	206
1888323M1	RL-08HV	197	1543016	RB-07H	141	A860T20570	RM-05HV	204
1895097M1	RL-15H	198	1543116	RB-07H	141	A860T21770	RM-01HV	204
1895097M1	RL-15	198	1543216	RB-01HA	140	A860T22370	RM-20HV	212
1895344M1	RL-04H	196	1543516	RB-42H	152	A860T22570	RM-07HV	205
1897094M1	RL-08HV	197	1544116	RB-43H	152	A860T22670	RM-07HV	205
1897267M1	RL-02H	196	1544616	RB-07H	141	A860T22770	RM-03HV	204
1897344M1	RL-04H	196	1545016	RB-01HA	140	A860T22970	RM-20HV	212
1897700M91	RL-01H	196	1545716	RB-07H	141	A860T23070	RM-43	216
3474574M1	RL-08HV	197	1545816	RB-08H	141	A860T23070	RM-40	216
3474648M91	RL-01H	196	1545916	RB-54H	153	A860T23270	RM-34HV	215
3475823M1	RL-05H	196	1546016	RB-07H	141	A860T23370	RM-43	216
3477529M91	RL-01H	196	1546216	RB-07H	141	A860T24270	RM-08HV	205
MAZDA			1546316	RB-08H	141	A860T24570	RM-19	211
135902	RM-46	217	1546416	RB-01HA	140	A860T25470	RM-20HV	212
1456-24-510	RH-16C	184	1546816	RB-01HA	140	A860T26070	RM-43	216
4130-24-510A	RM-75	220	1547016	RB-14H	146	A860T26470	RM-80	221
4130-24-510B	RM-74	220	1547616	RB-01HA	140	A860T27070	RM-16	209
4130-24-560	RM-75	220	1547916	RB-56H	153	A860T27170	RM-10HV	205
8173-24-510	RM-68	219	1548116	RB-01HA	140	A860T27270	RM-14	208
8173-24-510A	RM-69	220	1548216	RB-01HA	140	A860T27870	RM-01HV	204
8599-24-510	RM-71	220	MITSUBISHI			A860T28070	RM-43	216
B101-18-W60	RM-01HV	204	134373	RM-62	219	A860T28070	RM-40	216
B366-18-W60	RM-39HV	216	137486	RM-43	216	A860T28670	RM-29HV	215
B3C7-18-W60	RM-22	213	138893	RM-53HV	217	A860T28770	RM-30	215
B603-18-W60	RM-01HV	204	230261	RM-129	207	A860T30170	RM-42	216
B61P-18-W60	RM-23	213	88375-21274-5531Y	RM-222HV	213	A860T30370	RM-147	208
B64J-18-W60	RM-23	213	94675-C1323-7920H	RM-179	210	A860T31370	RM-31	215
B675-18-W60	RM-10HV	205	A4982-C1771-2518Y	RM-224	213	A860T31770	RM-44	217
D401-24-510	RM-60	218	A600C10301	RM-43	216	A860T32170	RM-57	218
D401-24-510B	RM-62	219	A860T03970	RM-68	219	A860T32470	RM-20HV	212
D501-24-510	RM-63	219	A860T04170	RM-75	220	A860T32570	RM-23	213
E301-24-510A	RM-75	220	A860T04370	RM-60	218	A860T33470	RM-98	222
E356-18-W60	RM-01HV	204	A860T05070	RM-60	218	A860T33970	RM-48	217
E356-18-W60	RM-02HV	204	A860T05170	RM-68	219	A860T34070	RM-31	215
E356-18-W60A	RM-01HV	204	A860T05270	RM-75	220	A860T35270	RM-41	216
E356-24-510	RM-67	219	A860T06070	RM-66	219	A860T36770	RM-45	217
E563-24-510	RM-67	219	A860T06082	RM-66	219	A860T37070	RM-22	213
E5D3-18-W60A	RM-08HV	205	A860T06270	RM-96	222	A860T37670	RM-39HV	216

CROSS REFERENCE
Voltage Regulator

CROSS REFERENCE
Rectifier

CROSS REFERENCE
Diode Trio

ALTERNATOR NO.
Reg & Rec

**CROSS REFERENCE
Rectifier**

OEM No. → Mobiletron No.

OEM No.	Part No.	Page	OEM No.	Part No.	Page	OEM No.	Part No.	Page
A860T37770	RM-23	213	GY-1302	RF-16HD	178	23232-18A00	RH-04N	181
A860T37870	RM-23	213	GY-1302B	RF-16HD	178	23232-18A00	RH-04	181
A860T38270	RM-98	222	GY-1302B	RF-16HV	178	23232-18A00	RH-04C	181
A860T38270	RM-38	216	GY-1306A	RF-08HV	177	23232-18G00	RH-04C	181
A860T38570	RM-27	214	GY-1306A	RF-08H	177	23232-18G00	RH-04	181
A860T38670	RM-46	217	GY-1306A	RF-07HV	177	23232-18G00	RH-04N	181
A860T38770	RM-36	215	GY-1327	RF-08H	177	23232-B8000	RH-49	187
A860T38970	RM-58	218	GY-1345A	RF-16HV	178	23232-E6601	RH-49	187
A860T39070	RM-59	218	GY-1345A	RF-16HD	178	23232-H6200	RH-49	187
A860T39070	RM-59HV	218	GY-1346	RF-16HD	178	23232-N3300	RH-49	187
A860T39170	RM-39HV	216	GY-1346	RF-16HV	178	23232-U0102	RH-49	187
A860T39770	RM-22	213	GY-1351	RF-01	176	23232-V6601	RH-04N	181
A860T40270	RM-46	217	GY-1360	RF-02	176	23232-V6601	RH-04	181
A860T41670	RM-97HV	222	MWM			23232-V6601	RH-04C	181
A860T42070	RM-47	217	8011080001	RB-13H	146	23232-W1700	RH-02	180
A860T42670	RM-50HV	217	8011080002	RB-08H	141	23232-W1700	RH-02C	180
A860T42770	RM-50HV	217	8339940004	RB-13H	146	23232-W1705	RH-14C	183
A860T46570	RM-124	206	833994001	RB-13H	146	23245-V7200	RH-15C	183
A860T57870	RM-110HV	206	8398150001	RB-13H	146	23245-V7200	RH-15	183
A860T88170	RM-189H	211	8398150001	RB-08H	141	28230-E3200	RH-04N	181
A860X18371	RM-15	208	839815001	RB-13H	146	28230-E3200	RH-04	181
A860X20099	RM-24	214	NIKKO			OPEL		
A860X31799	RM-44	217	7-44000-0900	RT-06H	226	1205409	RD-18HA	161
A860X34799	RM-44	217	NISSAN			1205409	RD-18H	161
A860X42770	RM-59HV	218	23124-04F10	RM-06	204	1205449	RB-02H	140
A860X44170	RM-59HV	218	23124-05E16	RM-76	220	1205453	RB-54H	153
A860X44170	RM-59	218	23124-05P10	RM-06	204	1205454	RD-20HA	161
A860X45281	RM-23	213	23124-08E16	RM-09HV	205	1205455	RB-55H	153
A860X45670	RM-22	213	23124-17B10	RM-81	221	1205550	RB-02H	140
A860X46570	RM-124	206	23124-4P116	RM-231HV	214	1205551	RB-02H	140
A860X47070	RM-116	206	23124-53A10	RM-05HV	204	1205552	RB-12H	145
A860X49270	RM-152	209	23124-58L10	RM-12	206	1205553	RB-02H	140
A860X52570	RM-170	210	23124-77A10	RM-14	208	1205555	RB-02H	140
A860X52670	RM-157H	209	23124-B9810	RM-60	218	1205557	RB-02H	140
A860X61870	RM-146	208	23124-JK01A	RM-199	211	1205558	RB-02H	140
A860X61970	RM-130	207	23124-OE711	RM-22	213	1205559	RB-02H	140
A860X64570	RM-231HV	214	23124-OE712	RM-22	213	1205561	RB-01HA	140
A860X70970	RM-129A	207	23124-Q4610	RM-75	220	1205562	RB-02H	140
A860X79470	RM-127	207	23124-W1715	RM-96	222	1205565	RB-02H	140
A860X83370	RM-136	208	23124-W5811	RM-85	221	1205568	RB-17H	148
A860X85670	RM-192	211	23215-31U05	RV-H040	192	1205569	RB-02H	140
A866X45281	RM-28	214	23230-04D00	RM-73	220	1205571	RB-19H	150
MD611599	RM-43	216	23230-04F10	RM-06	204	1205572	RB-18H	150
MD611742	RM-43	216	23230-06500	RH-12C	183	1205573	RB-19H	150
mitsubishi motors			23230-06500	RH-01	180	6205432	RD-29	162
MD607370	RM-68	219	23230-06500	RH-11C	182	90010012	RB-17H	148
MD607385	RM-75	220	23230-06500	RH-01C	180	90017587	RB-19H	150
MD607429	RM-60	218	23230-0E705	RH-25	185	90140010	RB-02H	140
MD607441	RM-68	219	23230-0L700	RH-77	189	90349703	RB-54H	153
MD607529	RM-75	220	23230-12G01	RH-22	184	90349855	RB-55H	153
MD607568	RM-66	219	23230-1E400	RH-29	185	90443928	RB-54H	153
MD607616	RM-65	219	23230-37504	RH-18C	184	PERKINS		
MD607680	RM-73	220	23230-50Y06	RH-24	185	28710225	RL-02H	196
MD607693	RM-83	221	23230-50Y09	RH-26	185	28710236	RL-02H	196
MD607818	RM-74	220	23230-51S00	RH-39C	186	28710243	RL-04H	196
MD607828	RM-15	208	23230-53F00	RH-22	184	28710253	RL-01H	196
MD607828	RM-01HV	204	23230-56G00	RH-29	185	PEUGEOT		
MD607917	RM-07HV	205	23230-64J00	RH-23	184	5722.98	RI-06H	199
MD611254	RM-04HV	204	23230-77A00	RH-40C	187	5744.02	RP-14	231
MD611256	RM-07HV	205	23230-77P00	RH-22	184	5744.52	RB-02H	140
MD611307	RM-11	205	23230-B9800	RH-51	187	5744.61	RP-04HR	229
MD611479	RM-20HV	212	23230-E3200	RH-50	187	5744.63	RB-02H	140
MD611501	RM-18	210	23230-F6101	RH-43C	187	5744.67	RB-02H	140
MD611564	RM-40	216	23230-H0300	RH-49	187	5744.86	RB-02H	140
MD611586	RM-34HV	215	23230-P2501	RH-51	187	5744.88	RB-02H	140
MD611688	RM-07HV	205	23230-P4505	RH-09C	181	POCLAIN		
MD611768	RM-40	216	23230-Q4601	RH-01C	180	B2140611	RB-07H	141
MD618568	RM-36	215	23230-Q4601	RH-11C	182	C2140612	RB-07H	141
MD618734	RM-50HV	217	23230-Q4601	RH-12C	183	POONG SUNG		
MD618752	RM-50HV	217	23230-Q4601	RH-01	180	RES14703	RK-04	193
MD618811	RM-59	218	23230-Q9000	RL-22H	198	RENAULT		
MD618811	RM-59HV	218	23230-U0100	RH-49	187	1127320960	RB-73H	155
MD618844	RM-124	206	23230-V4360	RH-43C	187	ROVER		
MD618950	RM-152	209	23230-W7101	RH-10C	182	AEU1527	RL-05H	196
ME700555	RM-86	222	23230-W7101	RH-03C	180	AEU1527J	RL-05H	196
ME700636	RM-73	220	23230-W7101	RH-03	180	BAU1825L	RL-02H	196
ME700836	RM-73	220	23232-02N09	RH-04N	181	BAU1996	RL-04H	196
ME701569	RM-170	210	23232-09W01	RH-04N	181	BAU2191	RL-04H	196
ME701570	RM-157H	209	23232-09W01	RH-04	181	BAU4920	RL-01H	196
ME701716	RM-116	206	23232-09W01	RH-04C	181	BAU5266	RL-01H	196
MOTORCRAFT			23232-10G01	RH-04C	181	BAU5813	RL-01H	196
GL-331	RF-063	176	23232-10G01	RH-04	181	BAU5816	RL-22H	198
GY-1026	RF-09H	177	23232-10G01	RH-04N	181	LBU5225	RL-09H	197
GY-1026A	RF-09HV	177	23232-16A00	RH-04N	181	RTC3213	RL-04H	196
GY-1302	RF-16HV	178	23232-16A00	RH-04	181	RTC5045	RL-01H	196

**CROSS REFERENCE
Rectifier**

OEM No. → Mobiletron No.

OEM No.	Part No.	Page	OEM No.	Part No.	Page	OEM No.	Part No.	Page
RTC5371	RL-09H	197	27357-63020	RN-13PL	166	593366	RP-48	233
RTC5671	RL-09H	197	27357-63020	RN-13	166	593463	RP-62	223
RVI			27357-70081	RN-12	166	593487	RP-39H	233
5430020198	RL-02H	196	27357-72120	RN-15	167	593512	RP-42	223
5430020791	RL-02H	196	27357-74050	RN-03PL	165	593530	RP-51	233
5430021884	RL-01H	196	27357-74120	RN-14	167	593667	RP-41	233
SAAB			27357-74160	RN-03PL	165	593797	RD-27H	162
282916	RB-08H	141	27357-74290	RN-14	167	809162	RM-123	203
424968	RB-78HA	155	27362-15070	RN-20	168	811875	RM-123	203
8518854	RB-01HA	140	27362-15070	RN-22	168	A418320A	RT-01H	226
8550113	RB-02H	140	27362-43020	RN-22	168	A559893A	RL-22H	198
8559825	RB-02H	140	27362-43020	RN-20	168	A600C0231	RM-123	203
8571903	RB-02H	140	27362-63011	RN-31	169	A940677A	RT-10H	227
8591083	RB-02H	140	27375-6340	RN-16	167	IMR5005	RM-123	203
8598096	RB-05H	141	27375-6340	RN-16PL	167	NB094	RT-12H	227
9555301	RB-05H	141	27375-72150	RN-15PL	167	NB095	RT-03H	226
9555293	RB-01HA	140	27375-72150	RN-15	167	NB117	RT-07H	227
SAME			VALEO			NB120	RT-07H	227
294390902	RB-10H	142	101217	RP-04H	229	NB121	RT-21H	227
294391601	RB-02H	140	101759	RP-04H	229	NB122	RT-07H	227
SCANIA			103539	RP-04H	229	NB123	RT-07H	227
1347012	RB-78H	155	103576	RP-04H	229	NB126	RT-08H	227
282916	RB-08H	141	104292	RP-04H	229	NB128	RT-05H	226
305158	RB-08H	141	104971	RP-04H	229	NB136	RT-07H	227
SEAT			136738	RM-123	203	NB138	RT-08H	227
3898152	RB-10H	142	137486	RM-43	216	NB142	RT-05H	226
3980278	RB-02H	140	235653	RP-51	233	NB427	RT-02H	226
3980591	RB-01HA	140	2522084	RT-09H	227	NB428	RT-06H	226
NG32033229	RB-01HA	140	2522148	RT-05H	226	NB435	RT-06H	226
NG981008.29	RB-10H	142	2522165	RT-05H	226	NB436	RT-07H	227
NG981025.29	RB-02H	140	2522172	RT-02H	226	NB439	RT-07H	227
SEV MARCHAL			2522173	RT-02H	226	NB444	RT-01H	226
71215003	RP-04	229	2522178	RT-03H	226	NB739	RT-06H	226
71215103	RP-04	229	2522179	RT-01H	226	NB744	RT-06H	226
71215303	RP-03	229	2522190	RT-06H	226	NB751	RT-02H	226
71215403	RP-04R	230	2522190	RT-21H	227	NB763	RT-06H	226
71215603	RP-04	229	2522197	RT-08H	227	NB785	RT-21H	227
71216203	RP-04	229	2522200	RT-04H	226	NB787	RT-09H	227
71216903	RP-04	229	2522208	RT-08H	227	NC013	RU-01	225
SONACOME			2546040	RP-37	232	NC013	RU-01H	225
1120314	RB-07H	141	2546041	RP-37	232	NC014	RU-01H	225
1124036	RB-07H	141	2547906	RP-62	223	NC014	RU-01	225
STEYR			2548083	RP-38	233	NC124	RP-10	231
30800090739	RB-10H	142	2603196	RP-57	223	NC126	RP-11	231
61000090743	RB-01HA	140	2650237	RP-66	223	NC133	RP-03	229
61200090706	RB-01HA	140	2650430	RD-27H	162	NC134	RP-04R	230
61200090706	RB-08H	141	501049	RT-01H	226	NC136	RP-02	229
SUBARU			501077	RT-08H	227	NC137	RP-06H	230
23830-AA020	RH-40C	187	501079	RT-21H	227	NC138	RP-04	229
23830-AA030	RM-42	216	501102	RT-09H	227	NC139	RP-03	229
23830-AA040	RH-21	184	546351	RP-36	232	NC141	RP-07	230
23830-AA100	RH-33	186	5498776	RP-52	223	NC142	RP-09R	231
23830-AA100	RH-75	189	592254	RT-09H	227	NC143	RP-08	230
23830-AA130	RM-130	207	592554	RT-09H	227	NC144	RP-04H	229
23830-AA140	RH-33	186	592555	RT-05H	226	NC145	RP-01	229
23830-AA140	RH-75	189	592595	RP-04H	229	NC161	RP-06HR	230
23830-AA180	RH-33	186	592-596	RP-04	229	NC216	RP-03	229
23830-KA070	RM-03HV	204	592754	RP-02	229	NC217	RP-04R	230
31441-00-808	RH-49	187	592779	RP-04H	229	NC388	RP-04	229
49534-7001	RH-09C	181	592842	RP-48	233	NC481	RT-05H	226
49534-7101	RH-01C	180	592842	RP-24	232	NC730	RP-02	229
49534-7101	RH-11C	182	592842	RP-16	231	NC877	RP-04	229
49534-7101	RH-12C	183	592845	RP-15	231	NC936	RP-03	229
49534-7101	RH-01	180	592848	RP-37	232	NC976	RP-09	230
TALBOT			592877	RP-04H	229	NF006	RP-14	231
35140800	RL-15	198	592880	RP-08	230	NF007	RP-17	232
35140800	RL-15H	198	592881	RP-07	230	VALEO(DUCELLIER)		
43278800	RB-02H	140	593172	RP-35	232	581025	RU-01	225
5059884	RL-12H	197	593174	RP-23	232	581025	RU-01H	225
75061613	RL-08HV	197	593175	RP-22	232	581071	RU-01H	225
TOSHIBA			593180	RP-04H	229	581071	RU-01	225
6M3	RI-05H	199	593188	RP-02	229	581078	RU-01	225
7G2	RI-07H	175	593190	RP-08	230	581078	RU-01H	225
7H4	RI-07H	175	593193	RP-08	230	592837	RT-06H	226
7M2	RI-08H	175	593199	RP-02	229	593027	RT-09H	227
TOYOTA			593202	RP-37	232	593062	RL-17H	198
27060-0C020	RN-45	170	593204	RP-48	233	593068	RT-01H	226
27060-0C021	RN-45	170	593306	RP-23	232	593069	RT-06H	226
27060-72010	RN-13PL	166	593309	RP-02	229	593070	RT-02H	226
27060-72010	RN-13	166	593320	RP-27	232	593073	RT-05H	226
27357-16310	RN-03PL	165	593327	RP-48	233	593074	RU-01	225
27357-22050	RN-36	169	593329	RP-23	232	593074	RU-01H	225
27357-22200	RN-36	169	593348	RP-48	233	606625	RU-01H	225
27357-55080	RN-03PL	165	593351	RP-48	233	606625	RU-01	225
27357-62040	RN-03PL	165	593364	RP-48	233	611197	RU-01	225

CROSS REFERENCE
Voltage Regulator

CROSS REFERENCE
Rectifier

CROSS REFERENCE
Diode Trio

ALTERNATOR NO.
Reg & Rec

**CROSS REFERENCE
Rectifier**

OEM No. → Mobiletron No.

OEM No.	Part No.	Page	OEM No.	Part No.	Page	OEM No.	Part No.	Page
611197	RU-01H	225	501-105	RT-05H	226	2698242	RL-12H	197
611199	RU-01H	225	501-106	RT-08H	227	91062513	RL-15H	198
611199	RU-01	225	501-107	RT-07H	227	91062513	RL-15	198
611788	RU-01	225	501-108	RT-07H	227	91103214	RL-15	198
611788	RU-01H	225	501-109	RT-08H	227	91103214	RL-15H	198
618093	RU-01H	225	501-110	RT-08H	227	VOLKSWAGEN		
618093	RU-01	225	501-111	RT-06H	226	028-903-359G	RB-178H	148
618439	RU-01	225	501-112	RT-07H	227	VOLVO		
618439	RU-01H	225	501-114	RT-07H	227	1235288	RB-02H	140
618503	RU-01H	225	501-115	RT-07H	227	1235577	RB-02H	140
618503	RU-01	225	501-116	RT-08H	227	1259577	RB-02H	140
618720	RU-01	225	501-118	RT-07H	227	1363914	RB-02H	140
618720	RU-01H	225	501-119	RT-21H	227	1698182	RB-66H	154
690260	RU-01H	225	501-120	RT-08H	227	1698762	RB-78HA	155
690260	RU-01	225	501-123	RT-08H	227	243949	RB-02H	140
690971	RU-01	225	501-124	RT-05H	226	243950	RB-02H	140
690971	RU-01H	225	501-46	RT-01H	226	244343	RB-07H	141
VALEO(MOTOROLA)			VALEO(PARIS RHONE)			244488	RB-07H	141
101-205	RT-24HD	228	100157	RP-03	229	244610	RB-72H	154
2523321	RT-10H	227	100931	RP-04	229	3090260	RB-71H	154
501-001	RT-06H	226	101217	RP-03	229	3090262	RB-71H	154
501-002	RT-08H	227	101227	RP-06H	230	3097306	RB-78H	155
501-003	RT-07H	227	101342	RP-06HR	230	6239264	RB-08H	141
501-004	RT-05H	226	101713	RP-05H	230	68132	RB-71H	154
501-006	RT-05H	226	101743	RP-01	229	692060	RB-02H	140
501-007	RT-05H	226	101759	RP-03	229	694461	RB-02H	140
501-008	RT-07H	227	101773	RP-04R	230	696002	RB-78HA	155
501-009	RT-06H	226	101776	RP-04R	230	698121	RB-72H	154
501-010	RT-08H	227	102527	RP-01	229	9130086	RB-04H	140
501-011	RT-08H	227	102556	RP-02	229	9130092	RB-05H	141
501-012	RT-07H	227	102817	RP-19	232	94095	RB-08H	141
501-014	RT-09H	227	103539	RP-03	229	VOLVO/DAF		
501-015	RT-07H	227	103543	RP-01	229	1363741	RB-60H	154
501-017	RT-08H	227	103546	RP-04R	230	1398640	RB-59H	154
501-018	RT-08H	227	103551	RP-02	229	9130095	RB-55H	153
501-019	RT-07H	227	103576	RP-03	229	YANMAR		
501-020	RT-09H	227	104269	RP-06H	230	L135-332000	RH-20C	184
501-023	RT-12H	227	104292	RP-03	229			
501-024	RT-02H	226	104615	RP-08	230			
501-025	RT-07H	227	104971	RP-04	229			
501-026	RT-12H	227	105135	RP-03	229			
501-027	RT-03H	226	105135	RP-03	229			
501-030	RT-05H	226	105252	RP-07	230			
501-032	RT-07H	227	105380	RP-01	229			
501-034	RT-21H	227	105522	RP-08	230			
501-037	RT-01H	226	105523	RP-08	230			
501-038	RT-01H	226	105554	RP-04HR	229			
501-039	RT-07H	227	105629	RP-03	229			
501-041	RT-07H	227	105690	RP-07	230			
501-043	RT-07H	227	105813	RP-09R	231			
501-044	RT-05H	226	106016	RP-08	230			
501-046	RT-01H	226	180537	RP-04H	229			
501-047	RT-07H	227	180593	RP-01	229			
501-048	RT-07H	227	181155	RP-02	229			
501-052	RT-08H	227	2181241	RP-04HR	229			
501-053	RT-06H	226	2545941	RP-17	232			
501-054	RT-12H	227	2546062	RP-14	231			
501-056	RT-07H	227	2546076	RP-14	231			
501-057	RT-08H	227	300082	RP-03	229			
501-058	RT-05H	226	300903	RP-21	232			
501-059	RT-08H	227	300903	RP-20	232			
501-060	RT-09H	227	350011	RP-04	229			
501-061	RT-21H	227	545940	RP-17	232			
501-062	RT-07H	227	592747	RP-09	230			
501-063	RT-02H	226	592747	RP-09R	231			
501-065	RT-01H	226	592749	RP-09	230			
501-066	RT-21H	227	592844	RP-14	231			
501-067	RT-07H	227	592846	RP-17	232			
501-068	RT-07H	227	592847	RP-17	232			
501-069	RT-08H	227	592893	RT-20H	233			
501-071	RT-07H	227	592917	RP-14	231			
501-073	RT-07H	227	593194	RP-03	229			
501-076	RT-06H	226	78810	RP-11	231			
501-078	RT-21H	227	92086	RP-10	231			
501-092	RT-05H	226	92734	RP-11	231			
501-093	RT-06H	226	92785	RP-10	231			
501-095	RT-09H	227	92919	RP-10	231			
501-096	RT-07H	227	92928	RP-10	231			
501-097	RT-21H	227	92939	RP-10	231			
501-098	RT-07H	227	94450	RP-11	231			
501-100	RT-07H	227	96314	RP-11	231			
501-101	RT-07H	227	A546076A	RP-14	231			
501-102	RT-07H	227	VALMET					
501-103	RT-08H	227	8353310743	RB-01HA	140			
501-104	RT-04H	226	VAUXHALL					

CROSS REFERENCE
Voltage Regulator

CROSS REFERENCE
Rectifier

CROSS REFERENCE
Diode Trio

ALTERNATOR NO.
Reg & Rec

CROSS REFERENCE LIST

OEM Alternator No. → Mobiletron No.

OEM Alternator No.	Rectifier No.	Page	Regulator No.	Page	OEM Alternator No.	Rectifier No.	Page	Regulator No.	Page
BOSCH									
0 120 468 143	RB-93H	157			0-120-300-592	RB-10H	142		
0 120 468 145	RB-93H	157			0-120-310-023	RB-105H	142		
0 120 469 101	RB-93H	157			0-120-310-048	RB-105H	142		
0 120 469 107	RB-93H	157			0-120-335-007			VR-B240H	16
0 120 469 108	RB-93H	157			0-120-335-011			VR-B240H	16
0 120 469 109	RB-93H	157			0-120-335-012			VR-B240H	16
0 120 469 110	RB-93H	157			0-120-339-502	RB-11H	144		
0 120 469 111	RB-93H	157			0-120-339-503	RB-11H	144		
0 120 469 112	RB-93H	157			0-120-339-504	RB-11H	144		
0 120 469 113	RB-93H	157			0-120-339-505	RB-11H	144		
0 120 469 114	RB-93H	157			0-120-339-506	RB-11H	144		
0 120 469 115	RB-93H	157			0-120-339-509	RB-11H	144		
0 120 469 116	RB-93H	157			0-120-339-510	RB-11H	144		
0 124 515 028			VR-B296	21	0-120-339-511	RB-13H	146		
0 125 711 041			VR-B823	25	0-120-339-512	RB-13H	146		
0 125 711 131			VR-B867	27	0-120-339-513	RB-13H	146		
0 125 711 132			VR-B867	27	0-120-339-514	RB-13H	146		
0 125 711 133?			VR-B867	27	0-120-339-515	RB-10H	142	VR-B193M	10
0 125 711 134			VR-B867	27	0-120-339-516	RB-10H	142	VR-B193M	10
0 125 811 061			VR-B0701	5	0-120-339-517	RB-11H	144		
0 125 811 071			VR-B0701	5	0-120-339-518	RB-11H	144		
0 125 811 083			VR-B867	27	0-120-339-519	RB-11H	144		
0 125 811 084			VR-B867	27	0-120-339-520	RB-11H	144		
0 125 811 085			VR-B867	27	0-120-339-521	RB-13H	146	VR-B193M	10
0 125 811 086			VR-B867	27	0-120-339-522	RB-11H	144		
0 125 811 101			VR-B0701	5	0-120-339-523	RB-10H	142		
0 125 811 111			VR-B0701	5	0-120-339-526	RB-10H	142	VR-B192	9
0 125 811 113			VR-B0701	5	0-120-339-527	RB-10H	142	VR-B192	9
0 125 812 012			VR-B823	25	0-120-339-528	RB-10H	142	VR-B192	9
0 125 812 037			VR-B823	25	0-120-339-531	RB-13H	146	VR-B193M	10
0 125 812 071			VR-B823	25	0-120-339-532	RB-13H	146		
0 125 812 073			VR-B823	25	0-120-339-534	RB-10H	142		
0 125 812 074			VR-B823	25	0-120-339-535	RB-13H	146		
0 125 812 075			VR-B823	25	0-120-339-536	RB-11H	144		
0001542405			VR-B268	20	0-120-339-537	RB-13H	146	VR-B197	12
0001542605			VR-B396	24	0-120-339-538	RB-13H	146	VR-B197	12
0001542705			VR-B396	24	0-120-339-542	RB-13H	146		
0031542606			VR-B396	24	0-120-339-544	RB-13H	146		
0-100-468-074	RB-87H	156			0-120-339-545	RB-13H	146		
0101549102	RB-93H	157			0-120-339-584	RB-13H	146		
0101549202	RB-93H	157			0-120-400-471	RB-02H	140		
0111547402			VR-B363	22	0-120-400-472	RB-02H	140		
01182475			VR-B268	20	0-120-400-522			VR-B190	8
0-120-000-003			VR-B056	5	0-120-400-537			VR-B191	9
0-120-000-019			VR-B268	20	0-120-400-607			VR-B190	8
0-120-000-023			VR-B243	16	0-120-400-620			VR-B191	9
0-120-000-025			VR-B020	4	0-120-400-630			VR-B190	8
0-120-000-029			VR-B056	5	0-120-400-654			VR-B191	9
0-120-110-007			VR-B240H	16	0-120-400-669	RB-01HA	140		
0-120-300-519	RB-11H	144			0-120-400-670	RB-01HA	140		
0-120-300-522	RB-11H	144			0-120-400-704	RB-01HA	140		
0-120-300-523	RB-11H	144			0-120-400-705	RB-01HA	140		
0-120-300-529	RB-11H	144			0-120-400-716			VR-B190	8
0-120-300-531	RB-12H	145			0-120-400-722	RB-01HA	140	VR-B191	9
0-120-300-533	RB-11H	144			0-120-400-723	RB-01HA	140		
0-120-300-535	RB-13H	146			0-120-400-724	RB-01HA	140		
0-120-300-537	RB-12H	145			0-120-400-726			VR-B190	8
0-120-300-539	RB-12H	145			0-120-400-728			VR-B191	9
0-120-300-540	RB-11H	144			0-120-400-733	RB-01HA	140		
0-120-300-544	RB-11H	144			0-120-400-740	RB-02H	140		
0-120-300-545	RB-11H	144			0-120-400-743	RB-02H	140		
0-120-300-546	RB-11H	144			0-120-400-745	RB-01HA	140		
0-120-300-547	RB-11H	144			0-120-400-747	RB-01HA	140		
0-120-300-548	RB-11H	144			0-120-400-750	RB-01HA	140		
0-120-300-551	RB-11H	144			0-120-400-758	RB-01HA	140	VR-B190	8
0-120-300-552	RB-13H	146			0-120-400-759	RB-01HA	140		
0-120-300-559	RB-11H	144			0-120-400-764			VR-B191	9
0-120-300-562	RB-13H	146			0-120-400-767			VR-B190	8
0-120-300-564	RB-11H	144			0-120-400-771	RB-02H	140	VR-B191	9
0-120-300-567	RB-13H	146			0-120-400-772	RB-02H	140		
0-120-300-568	RB-10H	142			0-120-400-782	RB-02H	140		
0-120-300-569	RB-10H	142			0-120-400-783	RB-02H	140		
0-120-300-575	RB-13H	146			0-120-400-803			VR-B190	8
0-120-300-576	RB-13H	146			0-120-400-807	RB-01HA	140		
0-120-300-577	RB-13H	146			0-120-400-808			VR-B191	9
0-120-300-578	RB-13H	146			0-120-400-809	RB-01HA	140		
0-120-300-579	RB-13H	146			0-120-400-810	RB-01HA	140		
0-120-300-580	RB-13H	146			0-120-400-811	RB-01HA	140		
0-120-300-584	RB-13H	146			0-120-400-815			VR-B190	8
0-120-300-585	RB-13H	146			0-120-400-827	RB-02H	140		
0-120-300-586	RB-13H	146			0-120-400-828	RB-02H	140		
0-120-300-588	RB-11H	144			0-120-400-831	RB-02H	140		
0-120-300-589	RB-13H	146			0-120-400-832	RB-02H	140		
0-120-300-590	RB-13H	146			0-120-400-833	RB-02H	140		
					0-120-400-834	RB-02H	140		

CROSS REFERENCE LIST

OEM Alternator No. → Mobiletron No.

OEM Alternator No.	Rectifier No.	Page	Regulator No.	Page	OEM Alternator No.	Rectifier No.	Page	Regulator No.	Page
0-120-400-836	RB-13H	146			0-120-468-020	RB-54H	153	VR-B195M	11
0-120-400-837	RB-13H	146			0-120-468-022	RB-54H	153	VR-B195M	11
0-120-400-838	RB-02H	140			0-120-468-023	RB-54H	153	VR-B195M	11
0-120-400-839	RB-02H	140			0-120-468-024	RB-54H	153		
0-120-400-840	RB-02H	140	VR-B191	9	0-120-468-025	RB-54H	153	VR-B195M	11
0-120-400-841	RB-02H	140			0-120-468-026	RB-54H	153	VR-B195M	11
0-120-400-849	RB-02H	140			0-120-468-027	RB-54H	153	VR-B195M	11
0-120-400-850	RB-02H	140			0-120-468-028	RB-67HA	154	VR-B194	10
0-120-400-852	RB-02H	140	VR-B190	8	0-120-468-029	RB-54H	153	VR-B195M	11
0-120-400-853	RB-02H	140			0-120-468-030	RB-77H	155	VR-B195M	11
0-120-400-854	RB-02H	140			0-120-468-031	RB-77H	155	VR-B195M	11
0-120-400-855	RB-02H	140			0-120-468-032	RB-87H	156	VR-B195M	11
0-120-400-856	RB-01HA	140			0-120-468-033			VR-B195M	11
0-120-400-857	RB-01HA	140			0-120-468-035			VR-B196M	11
0-120-400-858	RB-01HA	140	VR-B191	9	0-120-468-036			VR-B196M	11
0-120-400-859	RB-01HA	140			0-120-468-037	RB-66H	154	VR-B198	12
0-120-400-869			VR-B190	8	0-120-468-042	RB-49H	152	VR-B195M	11
0-120-400-889	RB-02H	140			0-120-468-043	RB-49H	152	VR-B195M	11
0-120-400-890	RB-02H	140			0-120-468-044	RB-54H	153		
0-120-400-901	RB-01HA	140			0-120-468-045			VR-B196M	11
0-120-400-903	RB-01HA	140			0-120-468-046			VR-B196M	11
0-120-400-906	RB-01HA	140			0-120-468-048	RB-87H	156		
0-120-400-910	RB-02H	140			0-120-468-049	RB-87H	156		
0-120-400-911	RB-02H	140			0-120-468-050	RB-77H	155	VR-B195M	11
0-120-400-912	RB-02H	140	VR-B191	9	0-120-468-051	RB-77H	155	VR-B195M	11
0-120-400-913	RB-02H	140			0-120-468-052	RB-54H	153	VR-B195M	11
0-120-400-914	RB-02H	140			0-120-468-053			VR-B210	15
0-120-400-915	RB-02H	140			0-120-468-055	RB-67HA	154		
0-120-400-917	RB-01HA	140			0-120-468-056	RB-54H	153	VR-B195M	11
0-120-400-921	RB-02H	140			0-120-468-059			VR-B196M	11
0-120-400-922	RB-02H	140			0-120-468-061	RB-49H	152		
0-120-400-926	RB-02H	140			0-120-468-062	RB-49H	152	VR-B195M	11
0-120-400-927	RB-02H	140			0-120-468-063	RB-49H	152		
0-120-400-928	RB-02H	140			0-120-468-064	RB-49H	152	VR-B195M	11
0-120-400-932	RB-02H	140			0-120-468-065	RB-72H	154	VR-B210	15
0-120-400-933	RB-02H	140			0-120-468-066			VR-B203	14
0-120-400-938	RB-02H	140			0-120-468-067	RB-77H	155	VR-B195M	11
0-120-400-939	RB-02H	140			0-120-468-068	RB-54H	153	VR-B195M	11
0-120-427-988	RB-54H	153			0-120-468-069	RB-54H	153		
0-120-450-001			VR-B190	8	0-120-468-070	RB-54H	153		
0-120-450-008	RB-47H	152			0-120-468-071	RB-87H	156		
0-120-450-009	RB-47H	152			0-120-468-072	RB-87H	156		
0-120-450-010	RB-72H	154			0-120-468-073	RB-87H	156		
0-120-450-012	RB-75H	155			0-120-468-074			VR-B195M	11
0-120-450-014	RB-75H	155			0-120-468-075	RB-49H	152		
0-120-450-015	RB-73H	155			0-120-468-076	RB-49H	152		
0-120-450-016	RB-75H	155			0-120-468-077	RB-49H	152		
0-120-450-017	RB-75H	155			0-120-468-078	RB-49H	152		
0-120-465-003	RB-29H	151			0-120-468-079	RB-54H	153		
0-120-465-004	RB-29H	151	VR-B201H	13	0-120-468-080	RB-96H	157		
0-120-465-006			VR-B208H	14	0-120-468-081	RB-96H	157		
0-120-465-007			VR-B200H	13	0-120-468-084	RB-96H	157		
0-120-465-008			VR-B200H	13	0-120-468-085	RB-96H	157		
0-120-465-010	RB-71H	154	VR-B200H	13	0-120-468-086	RB-96H	157		
0-120-465-012			VR-B201H	13	0-120-468-093			VR-B209	14
0-120-465-013	RB-29H	151	VR-B201H	13	0-120-468-094			VR-B209	14
0-120-465-014	RB-29H	151	VR-B201H	13	0-120-468-095	RB-77H	155		
0-120-465-015			VR-B201H	13	0-120-468-096	RB-77H	155		
0-120-465-016			VR-B201H	13	0-120-468-097	RB-87H	156		
0-120-465-017			VR-B201H	13	0-120-468-098	RB-87H	156		
0-120-465-018	RB-28H	151			0-120-468-101	RB-54H	153		
0-120-465-019	RB-178H	148			0-120-468-102	RB-49H	152	VR-B195M	11
0-120-465-020			VR-B200H	13	0-120-468-103	RB-49H	152	VR-B195M	11
0-120-465-021	RB-178H	148	VR-B200H	13	0-120-468-104	RB-49H	152		
0-120-465-028			VR-B200H	13	0-120-468-105	RB-49H	152		
0-120-465-029	RB-28H	151			0-120-468-106	RB-54H	153		
0-120-465-031			VR-B200H	13	0-120-468-107	RB-71H	154		
0-120-468-001			VR-B195M	11	0-120-468-108	RB-54H	153		
0-120-468-002			VR-B195M	11	0-120-468-109	RB-54H	153		
0-120-468-003			VR-B195M	11	0-120-468-110	RB-49H	152		
0-120-468-004			VR-B195M	11	0-120-468-112	RB-54H	153		
0-120-468-005			VR-B195M	11	0-120-468-113	RB-71H	154		
0-120-468-007	RB-77H	155	VR-B195M	11	0-120-468-114	RB-71H	154	VR-B209	14
0-120-468-008	RB-77H	155	VR-B195M	11	0-120-468-116			VR-B209	14
0-120-468-009	RB-59H	154	VR-B196M	11	0-120-468-118			VR-B209	14
0-120-468-010	RB-59H	154	VR-B196M	11	0-120-468-119	RB-96H	157		
0-120-468-011	RB-59H	154	VR-B196M	11	0-120-468-120	RB-96H	157		
0-120-468-012	RB-59H	154			0-120-468-121	RB-54H	153		
0-120-468-013	RB-87H	156	VR-B195M	11	0-120-468-123	RB-54H	153		
0-120-468-014	RB-87H	156	VR-B195M	11	0-120-468-124	RB-71H	154	VR-B209	14
0-120-468-015	RB-59H	154	VR-B196M	11	0-120-468-125	RB-54H	153		
0-120-468-016	RB-59H	154	VR-B196M	11	0-120-468-126	RB-54H	153		
0-120-468-017	RB-54H	153	VR-B195M	11	0-120-468-129			VR-B209	14
0-120-468-018	RB-54H	153	VR-B195M	11	0-120-468-130			VR-B209	14
0-120-468-019	RB-54H	153	VR-B195M	11	0-120-468-131	RB-71H	154		

**CROSS REFERENCE
Voltage Regulator**

**CROSS REFERENCE
Rectifier**

**CROSS REFERENCE
Diode Trio**

**ALTERNATOR NO.
Reg & Rec**

CROSS REFERENCE LIST

OEM Alternator No. → Mobiletron No.

	OEM Alternator No.	Rectifier No.	Page	Regulator No.	Page	OEM Alternator No.	Rectifier No.	Page	Regulator No.	Page
CROSS REFERENCE Voltage Regulator	0-120-468-137	RB-71H	154			0-120-469-568	RB-47H	152	VR-B196M	11
	0-120-468-518	RB-73H	155			0-120-469-569	RB-63H	154	VR-B210	15
	0-120-469-002	RB-54H	153			0-120-469-579	RB-72H	154		
	0-120-469-003	RB-54H	153			0-120-469-580	RB-72H	154	VR-B198	12
	0-120-469-008	RB-71H	154			0-120-469-581			VR-B195M	11
	0-120-469-009	RB-53H	153			0-120-469-582			VR-B195M	11
	0-120-469-010	RB-71H	154	VR-B209	14	0-120-469-583	RB-43H	152	VR-B196M	11
	0-120-469-011	RB-54H	153			0-120-469-584	RB-43H	152	VR-B196M	11
	0-120-469-012	RB-54H	153			0-120-469-585	RB-73H	155	VR-B198	12
	0-120-469-014	RB-62H	154	VR-B209	14	0-120-469-586	RB-41H	152	VR-B195M	11
CROSS REFERENCE Rectifier	0-120-469-015	RB-56H	153			0-120-469-588	RB-41H	152	VR-B195M	11
	0-120-469-016	RB-54H	153			0-120-469-589	RB-41H	152	VR-B196M	11
	0-120-469-017	RB-54H	153			0-120-469-590	RB-41H	152		
	0-120-469-018			VR-B209	14	0-120-469-591	RB-54H	153		
	0-120-469-019	RB-71H	154			0-120-469-592	RB-05H	141	VR-B198	12
	0-120-469-020	RB-56H	153			0-120-469-593			VR-B195M	11
	0-120-469-021	RB-56H	153			0-120-469-594			VR-B195M	11
	0-120-469-022	RB-71H	154	VR-B209	14	0-120-469-595			VR-B195M	11
	0-120-469-023	RB-71H	154	VR-B209	14	0-120-469-598	RB-46H	152		
	0-120-469-025	RB-71H	154			0-120-469-599	RB-46H	152		
CROSS REFERENCE Diode Trio	0-120-469-026	RB-71H	154			0-120-469-600			VR-B195M	11
	0-120-469-027	RB-71H	154			0-120-469-603	RB-07H	141	VR-B195M	11
	0-120-469-028	RB-51H	153			0-120-469-604			VR-B195M	11
	0-120-469-029	RB-51H	153			0-120-469-606			VR-B195M	11
	0-120-469-030	RB-71H	154			0-120-469-607			VR-B195M	11
	0-120-469-031	RB-71H	154	VR-B209	14	0-120-469-608			VR-B196M	11
	0-120-469-032	RB-53H	153			0-120-469-609			VR-B196M	11
	0-120-469-034	RB-51H	153			0-120-469-610	RB-07H	141	VR-B195M	11
	0-120-469-035	RB-51H	153			0-120-469-611			VR-B196M	11
	0-120-469-038	RB-73H	155			0-120-469-617			VR-B195M	11
ALTERNATOR NO. Reg & Rec	0-120-469-100	RB-93H	157			0-120-469-618	RB-55H	153	VR-B195M	11
	0-120-469-102	RB-93H	157			0-120-469-619	RB-55H	153	VR-B195M	11
	0-120-469-103	RB-93H	157	VR-B226	16	0-120-469-620			VR-B196M	11
	0-120-469-501			VR-B193M	10	0-120-469-621			VR-B195M	11
	0-120-469-502			VR-B193M	10	0-120-469-622			VR-B195M	11
	0-120-469-503			VR-B193M	10	0-120-469-623	RB-40H	152	VR-B195M	11
	0-120-469-504			VR-B193M	10	0-120-469-624			VR-B195M	11
	0-120-469-505			VR-B193M	10	0-120-469-628	RB-47H	152		
	0-120-469-509			VR-B197	12	0-120-469-629	RB-72H	154	VR-B194	10
	0-120-469-513			VR-B193M	10	0-120-469-630	RB-72H	154	VR-B194	10
0-120-469-514			VR-B193M	10	0-120-469-631	RB-51H	153	VR-B195M	11	
0-120-469-515	RB-43H	152	VR-B193M	10	0-120-469-632	RB-51H	153	VR-B195M	11	
0-120-469-518	RB-72H	154	VR-B210	15	0-120-469-633	RB-51H	153	VR-B195M	11	
0-120-469-519	RB-72H	154	VR-B198	12	0-120-469-634			VR-B210	15	
0-120-469-520	RB-72H	154	VR-B198	12	0-120-469-635	RB-51H	153			
0-120-469-521	RB-72H	154	VR-B198	12	0-120-469-636	RB-51H	153	VR-B195M	11	
0-120-469-522	RB-62H	154	VR-B194	10	0-120-469-637			VR-B195M	11	
0-120-469-523	RB-73H	155	VR-B209	14	0-120-469-638			VR-B195M	11	
0-120-469-524			VR-B193M	10	0-120-469-641	RB-55H	153			
0-120-469-525			VR-B193M	10	0-120-469-642	RB-54H	153			
0-120-469-526	RB-72H	154	VR-B202L	14	0-120-469-643	RB-63H	154	VR-B210	15	
0-120-469-527	RB-72H	154	VR-B198	12	0-120-469-644			VR-B196M	11	
0-120-469-528			VR-B193M	10	0-120-469-645			VR-B196M	11	
0-120-469-532	RB-72H	154	VR-B194	10	0-120-469-646	RB-52H	153			
0-120-469-533			VR-B193M	10	0-120-469-647	RB-52H	153			
0-120-469-534	RB-43H	152			0-120-469-648	RB-54H	153	VR-B195M	11	
0-120-469-535	RB-43H	152			0-120-469-649	RB-54H	153	VR-B195M	11	
0-120-469-538			VR-B193M	10	0-120-469-652	RB-73H	155			
0-120-469-539			VR-B193M	10	0-120-469-653	RB-72H	154	VR-B198	12	
0-120-469-540	RB-72H	154	VR-B202L	14	0-120-469-655	RB-57H	153			
0-120-469-541	RB-46H	152	VR-B195M	11	0-120-469-656	RB-57H	153			
0-120-469-542	RB-46H	152	VR-B195M	11	0-120-469-657	RB-57H	153			
0-120-469-543	RB-46H	152	VR-B196M	11	0-120-469-658	RB-57H	153			
0-120-469-544	RB-46H	152	VR-B196M	11	0-120-469-659	RB-53H	153			
0-120-469-545			VR-B195M	11	0-120-469-660	RB-53H	153			
0-120-469-546			VR-B195M	11	0-120-469-661	RB-53H	153	VR-B195M	11	
0-120-469-547			VR-B196M	11	0-120-469-662	RB-53H	153	VR-B195M	11	
0-120-469-548			VR-B195M	11	0-120-469-663	RB-56H	153			
0-120-469-549	RB-63H	154	VR-B210	15	0-120-469-664	RB-47H	152	VR-B196M	11	
0-120-469-551			VR-B195M	11	0-120-469-665			VR-B196M	11	
0-120-469-552			VR-B195M	11	0-120-469-666	RB-52H	153			
0-120-469-553			VR-B195M	11	0-120-469-667	RB-55H	153			
0-120-469-554			VR-B195M	11	0-120-469-668	RB-47H	152	VR-B196M	11	
0-120-469-555	RB-43H	152	VR-B196M	11	0-120-469-669			VR-B196M	11	
0-120-469-556	RB-43H	152	VR-B195M	11	0-120-469-670	RB-47H	152	VR-B196M	11	
0-120-469-557			VR-B196M	11	0-120-469-671	RB-51H	153	VR-B195M	11	
0-120-469-558	RB-43H	152	VR-B195M	11	0-120-469-672	RB-51H	153	VR-B195M	11	
0-120-469-559			VR-B195M	11	0-120-469-673			VR-B210	15	
0-120-469-560			VR-B195M	11	0-120-469-674			VR-B195M	11	
0-120-469-561			VR-B195M	11	0-120-469-675			VR-B195M	11	
0-120-469-562	RB-72H	154	VR-B198	12	0-120-469-676	RB-54H	153			
0-120-469-563			VR-B196M	11	0-120-469-677	RB-54H	153			
0-120-469-564	RB-47H	152	VR-B196M	11	0-120-469-679	RB-63H	154	VR-B209	14	
0-120-469-566			VR-B195M	11	0-120-469-680	RB-47H	152	VR-B196M	11	
0-120-469-567	RB-47H	152	VR-B196M	11	0-120-469-681	RB-47H	152	VR-B196M	11	

CROSS REFERENCE LIST

OEM Alternator No. → Mobiletron No.

OEM Alternator No.	Rectifier No.	Page	Regulator No.	Page	OEM Alternator No.	Rectifier No.	Page	Regulator No.	Page
0-120-469-682			VR-B196M	11	0-120-469-787	RB-58H	153	VR-B196M	11
0-120-469-683	RB-55H	153	VR-B196M	11	0-120-469-790	RB-54H	153		
0-120-469-684	RB-55H	153	VR-B196M	11	0-120-469-793	RB-58H	153	VR-B196M	11
0-120-469-685	RB-55H	153	VR-B196M	11	0-120-469-794	RB-55H	153		
0-120-469-686			VR-B198	12	0-120-469-795	RB-55H	153		
0-120-469-687			VR-B194	10	0-120-469-797	RB-73H	155	VR-B203	14
0-120-469-689	RB-54H	153	VR-B195M	11	0-120-469-798	RB-72H	154	VR-B209	14
0-120-469-690	RB-54H	153	VR-B195M	11	0-120-469-799	RB-55H	153		
0-120-469-691			VR-B198	12	0-120-469-800	RB-55H	153	VR-B195M	11
0-120-469-692	RB-72H	154			0-120-469-801	RB-54H	153		
0-120-469-696	RB-51H	153	VR-B195M	11	0-120-469-802	RB-54H	153	VR-B195M	11
0-120-469-697	RB-51H	153	VR-B195M	11	0-120-469-804	RB-54H	153	VR-B195M	11
0-120-469-698	RB-51H	153	VR-B195M	11	0-120-469-805	RB-54H	153	VR-B195M	11
0-120-469-699	RB-51H	153			0-120-469-806	RB-54H	153		
0-120-469-700	RB-51H	153	VR-B195M	11	0-120-469-807	RB-73H	155	VR-B198	12
0-120-469-701			VR-B195M	11	0-120-469-808	RB-54H	153	VR-B195M	11
0-120-469-702			VR-B195M	11	0-120-469-809	RB-54H	153	VR-B195M	11
0-120-469-705			VR-B195M	11	0-120-469-810	RB-54H	153	VR-B195M	11
0-120-469-706			VR-B195M	11	0-120-469-811			VR-B196M	11
0-120-469-707			VR-B195M	11	0-120-469-812			VR-B196M	11
0-120-469-708	RB-51H	153	VR-B195M	11	0-120-469-813	RB-56H	153		
0-120-469-709	RB-54H	153	VR-B195M	11	0-120-469-814	RB-56H	153		
0-120-469-710	RB-52H	153			0-120-469-822			VR-B195M	11
0-120-469-711			VR-B195M	11	0-120-469-823			VR-B195M	11
0-120-469-712	RB-51H	153	VR-B195M	11	0-120-469-828	RB-48H	152		
0-120-469-713	RB-53H	153			0-120-469-829	RB-48H	152		
0-120-469-715	RB-51H	153			0-120-469-830	RB-48H	152		
0-120-469-716	RB-51H	153			0-120-469-831			VR-B195M	11
0-120-469-720	RB-51H	153			0-120-469-836	RB-52H	153		
0-120-469-721	RB-43H	152	VR-B195M	11	0-120-469-838	RB-58H	153		
0-120-469-722	RB-56H	153			0-120-469-839			VR-B195M	11
0-120-469-723	RB-56H	153			0-120-469-843	RB-72H	154	VR-B198	12
0-120-469-724	RB-56H	153			0-120-469-845			VR-B195M	11
0-120-469-725	RB-54H	153			0-120-469-846			VR-B195M	11
0-120-469-726	RB-54H	153			0-120-469-847	RB-51H	153		
0-120-469-727	RB-54H	153	VR-B195M	11	0-120-469-848	RB-51H	153		
0-120-469-728	RB-54H	153	VR-B195M	11	0-120-469-849			VR-B198	12
0-120-469-729	RB-54H	153	VR-B195M	11	0-120-469-850	RB-72H	154		
0-120-469-730	RB-54H	153			0-120-469-851	RB-73H	155	VR-B198	12
0-120-469-731	RB-54H	153	VR-B195M	11	0-120-469-852	RB-72H	154		
0-120-469-732	RB-54H	153	VR-B195M	11	0-120-469-853	RB-72H	154	VR-B194	10
0-120-469-733	RB-54H	153	VR-B195M	11	0-120-469-854	RB-73H	155		
0-120-469-734	RB-56H	153	VR-B195M	11	0-120-469-855	RB-72H	154	VR-B198	12
0-120-469-735	RB-56H	153	VR-B195M	11	0-120-469-856	RB-56H	153		
0-120-469-736	RB-56H	153			0-120-469-857	RB-56H	153		
0-120-469-737	RB-56H	153			0-120-469-858	RB-51H	153		
0-120-469-738	RB-56H	153			0-120-469-859	RB-51H	153		
0-120-469-739	RB-56H	153	VR-B195M	11	0-120-469-860	RB-51H	153		
0-120-469-740	RB-56H	153	VR-B195M	11	0-120-469-861	RB-51H	153		
0-120-469-741	RB-56H	153	VR-B195M	11	0-120-469-863	RB-56H	153		
0-120-469-742	RB-54H	153	VR-B195M	11	0-120-469-864			VR-B195M	11
0-120-469-743	RB-54H	153	VR-B195M	11	0-120-469-865			VR-B195M	11
0-120-469-744	RB-54H	153	VR-B196M	11	0-120-469-868			VR-B195M	11
0-120-469-745	RB-54H	153	VR-B196M	11	0-120-469-869			VR-B195M	11
0-120-469-746	RB-54H	153			0-120-469-871	RB-53H	153		
0-120-469-747	RB-53H	153			0-120-469-874	RB-53H	153		
0-120-469-748	RB-53H	153			0-120-469-875	RB-51H	153		
0-120-469-749	RB-72H	154	VR-B195M	11	0-120-469-878	RB-50H	152		
0-120-469-750	RB-60H	154			0-120-469-879	RB-50H	152		
0-120-469-751	RB-60H	154			0-120-469-881	RB-55H	153	VR-B196M	11
0-120-469-752	RB-73H	155			0-120-469-882	RB-58H	153	VR-B196M	11
0-120-469-753	RB-72H	154	VR-B198	12	0-120-469-883	RB-58H	153		
0-120-469-754			VR-B195M	11	0-120-469-884	RB-56H	153		
0-120-469-757	RB-55H	153	VR-B195M	11	0-120-469-890			VR-B198	12
0-120-469-758	RB-55H	153	VR-B195M	11	0-120-469-891	RB-71H	154	VR-B210	15
0-120-469-759	RB-55H	153	VR-B195M	11	0-120-469-892	RB-51H	153		
0-120-469-761	RB-72H	154	VR-B203	14	0-120-469-893	RB-51H	153		
0-120-469-762			VR-B202	13	0-120-469-896			VR-B196M	11
0-120-469-763	RB-72H	154	VR-B203	14	0-120-469-897			VR-B196M	11
0-120-469-768	RB-54H	153	VR-B195M	11	0-120-469-899	RB-53H	153		
0-120-469-772	RB-72H	154			0-120-469-900	RB-72H	154	VR-B209	14
0-120-469-773	RB-72H	154	VR-B198	12	0-120-469-902			VR-B195M	11
0-120-469-774	RB-56H	153			0-120-469-903	RB-56H	153	VR-B195M	11
0-120-469-775	RB-77H	155	VR-B195M	11	0-120-469-904	RB-56H	153		
0-120-469-776	RB-77H	155	VR-B195M	11	0-120-469-905	RB-72H	154	VR-B194	10
0-120-469-777	RB-54H	153	VR-B195M	11	0-120-469-908	RB-56H	153		
0-120-469-778	RB-54H	153	VR-B195M	11	0-120-469-910	RB-58H	153	VR-B195M	11
0-120-469-779	RB-54H	153	VR-B195M	11	0-120-469-913	RB-50H	152		
0-120-469-780	RB-54H	153			0-120-469-914	RB-50H	152	VR-B195M	11
0-120-469-781	RB-57H	153			0-120-469-915	RB-58H	153		
0-120-469-782	RB-54H	153	VR-B195M	11	0-120-469-916	RB-58H	153		
0-120-469-783	RB-54H	153	VR-B195M	11	0-120-469-918	RB-48H	152	VR-B195M	11
0-120-469-784	RB-58H	153			0-120-469-919	RB-48H	152	VR-B195M	11
0-120-469-785	RB-58H	153	VR-B196M	11	0-120-469-920	RB-73H	155	VR-B203	14
0-120-469-786	RB-58H	153	VR-B196M	11	0-120-469-922			VR-B195M	11

CROSS REFERENCE
Voltage Regulator

CROSS REFERENCE
Rectifier

CROSS REFERENCE
Diode Trio

ALTERNATOR NO.
Reg & Rec

CROSS REFERENCE LIST

OEM Alternator No. → Mobiletron No.

	OEM Alternator No.	Rectifier No.	Page	Regulator No.	Page	OEM Alternator No.	Rectifier No.	Page	Regulator No.	Page
CROSS REFERENCE Voltage Regulator	0-120-469-924	RB-58H	153	VR-B195M	11	0-120-484-173			VR-B195M	11
	0-120-469-926	RB-54H	153			0-120-484-175			VR-B195M	11
	0-120-469-927	RB-54H	153	VR-B196M	11	0-120-484-191			VR-B195M	11
	0-120-469-928	RB-54H	153	VR-B196M	11	0-120-484-193			VR-B195M	11
	0-120-469-929	RB-56H	153			0-120-484-201			VR-B195M	11
	0-120-469-930	RB-56H	153			0-120-484-203			VR-B195M	11
	0-120-469-931	RB-56H	153			0-120-484-204			VR-B195M	11
	0-120-469-932	RB-56H	153			0-120-484-205			VR-B103	6
	0-120-469-933	RB-56H	153			0-120-485-011	RB-121H	144	VR-B201H	13
	0-120-469-934	RB-56H	153			0-120-485-012	RB-121H	144	VR-B201H	13
0-120-469-935	RB-58H	153	VR-B196M	11	0-120-485-015			VR-B200H	13	
0-120-469-937	RB-51H	153			0-120-485-018			VR-B200H	13	
0-120-469-939	RB-51H	153			0-120-485-022	RB-121H	144	VR-B201H	13	
0-120-469-940	RB-51H	153			0-120-485-023			VR-B200H	13	
0-120-469-941	RB-54H	153			0-120-485-025			VR-B200H	13	
0-120-469-942	RB-54H	153			0-120-485-026			VR-B200H	13	
0-120-469-943	RB-54H	153			0-120-485-029	RB-160H	147			
0-120-469-946	RB-54H	153			0-120-485-034	RB-122H	144	VR-B200H	13	
0-120-469-947	RB-54H	153			0-120-485-036	RB-24H	151	VR-B200H	13	
0-120-469-948	RB-54H	153			0-120-485-038	RB-24H	151	VR-B200H	13	
0-120-469-949	RB-54H	153			0-120-485-039	RB-24H	151	VR-B200H	13	
0-120-469-950	RB-54H	153			0-120-485-043	RB-122H	144	VR-B200H	13	
0-120-469-951	RB-72H	154			0-120-485-044	RB-122H	144	VR-B200H	13	
0-120-469-952	RB-72H	154			0-120-485-048			VR-B200H	13	
0-120-469-953	RB-56H	153	VR-B195M	11	0-120-486-221	RB-07H	141			
0-120-469-955	RB-72H	154			0-120-486-353	RB-02H	140			
0-120-469-956			VR-B194	10	0-120-488-000	RB-17H	148			
0-120-469-958	RB-53H	153			0-120-488-001	RB-17H	148			
0-120-469-959	RB-72H	154	VR-B198	12	0-120-488-002	RB-17H	148			
0-120-469-960	RB-72H	154	VR-B203	14	0-120-488-003	RB-17H	148			
0-120-469-962	RB-54H	153			0-120-488-004	RB-17H	148			
0-120-469-967	RB-49H	152			0-120-488-005	RB-17H	148			
0-120-469-968	RB-49H	152			0-120-488-007	RB-17H	148			
0-120-469-969	RB-49H	152			0-120-488-008	RB-17H	148			
0-120-469-970	RB-54H	153			0-120-488-009	RB-17H	148			
0-120-469-971	RB-54H	153			0-120-488-010	RB-17H	148			
0-120-469-972	RB-54H	153			0-120-488-011	RB-17H	148			
0-120-469-973	RB-49H	152			0-120-488-012	RB-17H	148			
0-120-469-974	RB-49H	152			0-120-488-028	RB-02H	140			
0-120-469-975	RB-56H	153	VR-B195M	11	0-120-488-030	RB-02H	140			
0-120-469-976	RB-56H	153	VR-B195M	11	0-120-488-036	RB-02H	140			
0-120-469-977	RB-56H	153	VR-B195M	11	0-120-488-102	RB-02H	140	VR-B195M	11	
0-120-469-978	RB-71H	154	VR-B209	14	0-120-488-103	RB-02H	140	VR-B195M	11	
0-120-469-979	RB-51H	153			0-120-488-119	RB-01HA	140	VR-B195M	11	
0-120-469-980	RB-51H	153			0-120-488-120			VR-B196M	11	
0-120-469-981	RB-51H	153			0-120-488-121			VR-B196M	11	
0-120-469-984	RB-49H	152			0-120-488-122			VR-B196M	11	
0-120-469-985	RB-49H	152	VR-B195M	11	0-120-488-123	RB-02H	140			
0-120-469-989	RB-77H	155			0-120-488-125	RB-15H	147	VR-B198	12	
0-120-469-990	RB-77H	155			0-120-488-126	RB-01HA	140			
0-120-469-991	RB-56H	153			0-120-488-129	RB-02H	140			
0-120-469-992	RB-54H	153	VR-B196M	11	0-120-488-133			VR-B198	12	
0-120-469-993	RB-54H	153	VR-B196M	11	0-120-488-134	RB-04H	140	VR-B260	18	
0-120-469-995	RB-54H	153			0-120-488-136			VR-B198	12	
0-120-469-996	RB-54H	153			0-120-488-137	RB-07H	141	VR-B198	12	
0-120-469-997	RB-54H	153			0-120-488-138	RB-04H	140	VR-B260	18	
0-120-469-998	RB-54H	153			0-120-488-139	RB-02H	140			
0-120-469-999	RB-71H	154	VR-B209	14	0-120-488-141	RB-02H	140			
0-120-471-979	RB-72H	154			0-120-488-151	RB-02H	140			
0-120-484-001	RB-80H	155	VR-B202L	14	0-120-488-152	RB-02H	140			
0-120-484-002			VR-B194	10	0-120-488-153	RB-07H	141	VR-B203	14	
0-120-484-003			VR-B194	10	0-120-488-156	RB-19H	150			
0-120-484-004			VR-B195M	11	0-120-488-157	RB-19H	150			
0-120-484-005			VR-B195M	11	0-120-488-158	RB-19H	150			
0-120-484-006			VR-B195M	11	0-120-488-159	RB-19H	150			
0-120-484-008			VR-B195M	11	0-120-488-160	RB-19H	150			
0-120-484-009			VR-B195M	11	0-120-488-161	RB-19H	150			
0-120-484-010			VR-B195M	11	0-120-488-162	RB-19H	150			
0-120-484-011	RB-80H	155	VR-B260	18	0-120-488-163	RB-19H	150	VR-B195M	11	
0-120-484-012	RB-80H	155	VR-B195M	11	0-120-488-164	RB-19H	150			
0-120-484-013			VR-B195M	11	0-120-488-165	RB-19H	150			
0-120-484-014			VR-B195M	11	0-120-488-166	RB-19H	150			
0-120-484-015	RB-80H	155			0-120-488-167	RB-19H	150	VR-B195M	11	
0-120-484-017			VR-B202L	14	0-120-488-168	RB-19H	150			
0-120-484-018	RB-80H	155			0-120-488-169	RB-19H	150	VR-B195M	11	
0-120-484-020	RB-80H	155			0-120-488-170	RB-19H	150			
0-120-484-022	RB-80H	155			0-120-488-171	RB-19H	150	VR-B195M	11	
0-120-484-024	RB-80H	155			0-120-488-172	RB-19H	150			
0-120-484-157			VR-B195M	11	0-120-488-173	RB-19H	150			
0-120-484-159			VR-B195M	11	0-120-488-174	RB-19H	150			
0-120-484-161			VR-B195M	11	0-120-488-175	RB-19H	150			
0-120-484-165			VR-B195M	11	0-120-488-176	RB-06HA	141			
0-120-484-167			VR-B195M	11	0-120-488-177	RB-06HA	141			
0-120-484-169			VR-B195M	11	0-120-488-182	RB-06HA	141			
0-120-484-171			VR-B195M	11	0-120-488-185			VR-B202L	14	

CROSS REFERENCE LIST

OEM Alternator No. → Mobiletron No.

OEM Alternator No.	Rectifier No.	Page	Regulator No.	Page	OEM Alternator No.	Rectifier No.	Page	Regulator No.	Page
0-120-488-186	RB-18H	150			0-120-489-022	RB-07H	141	VR-B202	13
0-120-488-187	RB-18H	150			0-120-489-023	RB-07H	141	VR-B198	12
0-120-488-190	RB-19H	150			0-120-489-024	RB-01HA	140		
0-120-488-191	RB-19H	150			0-120-489-025			VR-B196M	11
0-120-488-192	RB-19H	150			0-120-489-026	RB-01HA	140	VR-B196M	11
0-120-488-193	RB-19H	150			0-120-489-027	RB-08H	141		
0-120-488-196	RB-05H	141			0-120-489-028			VR-B195M	11
0-120-488-197	RB-05H	141			0-120-489-029	RB-02H	140	VR-B195M	11
0-120-488-198	RB-05H	141			0-120-489-030			VR-B195M	11
0-120-488-199	RB-05H	141			0-120-489-031	RB-02H	140	VR-B195M	11
0-120-488-200	RB-19H	150			0-120-489-032	RB-07H	141	VR-B194	10
0-120-488-201	RB-19H	150			0-120-489-033			VR-B198	12
0-120-488-202	RB-19H	150	VR-B195M	11	0-120-489-034	RB-07H	141	VR-B198	12
0-120-488-203	RB-19H	150			0-120-489-035			VR-B198	12
0-120-488-204	RB-19H	150			0-120-489-036			VR-B195M	11
0-120-488-205	RB-04H	140	VR-B260	18	0-120-489-037	RB-02H	140	VR-B195M	11
0-120-488-206			VR-B260B	18	0-120-489-038			VR-B195M	11
0-120-488-208	RB-66H	154			0-120-489-039	RB-02H	140		
0-120-488-209			VR-B202L	14	0-120-489-040	RB-02H	140	VR-B195M	11
0-120-488-210	RB-06HA	141			0-120-489-041			VR-B195M	11
0-120-488-211	RB-02H	140			0-120-489-042	RB-02H	140	VR-B195M	11
0-120-488-218			VR-B194	10	0-120-489-044	RB-02H	140		
0-120-488-219			VR-B195M	11	0-120-489-046	RB-02H	140		
0-120-488-221	RB-02H	140			0-120-489-047	RB-06HA	141		
0-120-488-224	RB-08H	141	VR-B210	15	0-120-489-048	RB-06HA	141		
0-120-488-226	RB-04H	140			0-120-489-050			VR-B193M	10
0-120-488-227	RB-04H	140			0-120-489-051	RB-01HA	140		
0-120-488-228	RB-38H	151			0-120-489-052	RB-01HA	140		
0-120-488-232			VR-B198	12	0-120-489-053	RB-08H	141	VR-B198	12
0-120-488-233			VR-B260	18	0-120-489-054	RB-01HA	140		
0-120-488-234			VR-B260B	18	0-120-489-055			VR-B198	12
0-120-488-235	RB-02H	140			0-120-489-058	RB-02H	140		
0-120-488-236	RB-05H	141			0-120-489-059			VR-B204	14
0-120-488-237	RB-05H	141			0-120-489-060	RB-07H	141		
0-120-488-238	RB-04H	140			0-120-489-061	RB-01HA	140	VR-B196M	11
0-120-488-239	RB-05H	141			0-120-489-062	RB-01HA	140		
0-120-488-240	RB-05H	141			0-120-489-063	RB-01HA	140		
0-120-488-241	RB-04H	140			0-120-489-064	RB-01HA	140	VR-B196M	11
0-120-488-245	RB-04H	140			0-120-489-065			VR-B196M	11
0-120-488-246	RB-04H	140			0-120-489-066	RB-02H	140	VR-B196M	11
0-120-488-247	RB-04H	140			0-120-489-069	RB-16H	148	VR-B196M	11
0-120-488-249	RB-04H	140			0-120-489-070	RB-16H	148	VR-B196M	11
0-120-488-252	RB-02H	140			0-120-489-071	RB-07H	141	VR-B198	12
0-120-488-253	RB-02H	140			0-120-489-072			VR-B195M	11
0-120-488-254	RB-02H	140			0-120-489-073			VR-B195M	11
0-120-488-255	RB-19H	150			0-120-489-074	RB-06HA	141		
0-120-488-257	RB-04H	140			0-120-489-075	RB-06HA	141		
0-120-488-258	RB-04H	140			0-120-489-076	RB-01HA	140	VR-B195M	11
0-120-488-259	RB-04H	140			0-120-489-077	RB-01HA	140		
0-120-488-260	RB-04H	140			0-120-489-078			VR-B196M	11
0-120-488-261	RB-05H	141			0-120-489-079	RB-01HA	140	VR-B196M	11
0-120-488-262	RB-05H	141			0-120-489-080	RB-03HA	140	VR-B195M	11
0-120-488-263	RB-05H	141			0-120-489-081	RB-03HA	140	VR-B195M	11
0-120-488-264	RB-04H	140			0-120-489-082	RB-03HA	140		
0-120-488-265	RB-05H	141			0-120-489-083	RB-03HA	140		
0-120-488-272	RB-04H	140			0-120-489-088	RB-06HA	141		
0-120-488-273	RB-66H	154			0-120-489-090	RB-06HA	141	VR-B195M	11
0-120-488-274	RB-02H	140			0-120-489-091	RB-06HA	141	VR-B195M	11
0-120-488-275	RB-02H	140			0-120-489-093	RB-06HA	141		
0-120-488-276	RB-02H	140			0-120-489-094	RB-01HA	140	VR-B195M	11
0-120-488-279	RB-05H	141			0-120-489-095	RB-01HA	140		
0-120-488-281	RB-19H	150			0-120-489-097	RB-01HA	140		
0-120-488-283	RB-74H	155	VR-B260B	18	0-120-489-099	RB-01HA	140		
0-120-488-285	RB-04H	140			0-120-489-100	RB-01HA	140		
0-120-488-286	RB-38H	151			0-120-489-101	RB-01HA	140		
0-120-488-287	RB-02H	140			0-120-489-103	RB-06HA	141		
0-120-488-289	RB-07H	141			0-120-489-104			VR-B195M	11
0-120-488-294			VR-B260B	18	0-120-489-105			VR-B195M	11
0-120-488-298			VR-B260B	18	0-120-489-115			VR-B195M	11
0-120-488-900	RB-07H	141			0-120-489-125	RB-02H	140		
0-120-489-002			VR-B195M	11	0-120-489-127	RB-02H	140		
0-120-489-003	RB-01HA	140	VR-B195M	11	0-120-489-128			VR-B195M	11
0-120-489-004	RB-01HA	140	VR-B195M	11	0-120-489-129	RB-02H	140	VR-B195M	11
0-120-489-005	RB-01HA	140	VR-B195M	11	0-120-489-130			VR-B195M	11
0-120-489-006			VR-B196M	11	0-120-489-131	RB-02H	140	VR-B195M	11
0-120-489-007	RB-01HA	140	VR-B195M	11	0-120-489-133			VR-B195M	11
0-120-489-008			VR-B195M	11	0-120-489-134			VR-B195M	11
0-120-489-009	RB-01HA	140	VR-B195M	11	0-120-489-135	RB-02H	140		
0-120-489-010			VR-B195M	11	0-120-489-137	RB-02H	140		
0-120-489-011	RB-01HA	140	VR-B195M	11	0-120-489-139	RB-02H	140		
0-120-489-013	RB-01HA	140			0-120-489-143	RB-02H	140		
0-120-489-014			VR-B195M	11	0-120-489-148	RB-01HA	140		
0-120-489-015	RB-01HA	140	VR-B195M	11	0-120-489-149	RB-01HA	140	VR-B196M	11
0-120-489-017	RB-01HA	140	VR-B195M	11	0-120-489-150	RB-01HA	140	VR-B196M	11
0-120-489-021	RB-02H	140			0-120-489-152			VR-B195M	11

**CROSS REFERENCE
Voltage Regulator**

**CROSS REFERENCE
Rectifier**

**CROSS REFERENCE
Diode Trio**

**ALTERNATOR NO.
Reg & Rec**

CROSS REFERENCE LIST

OEM Alternator No. → Mobiletron No.

OEM Alternator No.	Rectifier No.	Page	Regulator No.	Page	OEM Alternator No.	Rectifier No.	Page	Regulator No.	Page
0-120-489-153	RB-02H	140	VR-B195M	11	0-120-489-298	RB-01HA	140		
0-120-489-154	RB-02H	140			0-120-489-299	RB-01HA	140		
0-120-489-155	RB-02H	140			0-120-489-300	RB-01HA	140		
0-120-489-156	RB-15H	147	VR-B194	10	0-120-489-301	RB-01HA	140		
0-120-489-162	RB-01HA	140			0-120-489-302	RB-01HA	140		
0-120-489-167	RB-02H	140	VR-B195M	11	0-120-489-303	RB-07H	141	VR-B210	15
0-120-489-168	RB-01HA	140			0-120-489-304	RB-01HA	140		
0-120-489-170			VR-B195M	11	0-120-489-305	RB-01HA	140		
0-120-489-171	RB-02H	140	VR-B195M	11	0-120-489-307	RB-02H	140		
0-120-489-172	RB-01HA	140			0-120-489-309			VR-B192	9
0-120-489-175	RB-06HA	141			0-120-489-311	RB-05H	141		
0-120-489-176	RB-06HA	141			0-120-489-312	RB-05H	141		
0-120-489-182	RB-02H	140			0-120-489-313	RB-06HA	141		
0-120-489-183	RB-16H	148	VR-B196M	11	0-120-489-314	RB-06HA	141		
0-120-489-184	RB-01HA	140	VR-B196M	11	0-120-489-315			VR-B202L	14
0-120-489-186	RB-03HA	140			0-120-489-316	RB-14H	146	VR-B203	14
0-120-489-188	RB-02H	140			0-120-489-317			VR-B194	10
0-120-489-189			VR-B196M	11	0-120-489-319	RB-02H	140		
0-120-489-190			VR-B196M	11	0-120-489-320			VR-B198	12
0-120-489-191	RB-02H	140			0-120-489-322	RB-01HA	140		
0-120-489-192	RB-08H	141	VR-B210	15	0-120-489-324	RB-01HA	140		
0-120-489-195			VR-B195M	11	0-120-489-325			VR-B196M	11
0-120-489-196	RB-01HA	140	VR-B195M	11	0-120-489-326	RB-01HA	140	VR-B196M	11
0-120-489-197	RB-01HA	140	VR-B195M	11	0-120-489-327	RB-01HA	140	VR-B196M	11
0-120-489-199	RB-01HA	140			0-120-489-328			VR-B196M	11
0-120-489-200			VR-B195M	11	0-120-489-329	RB-01HA	140		
0-120-489-201	RB-01HA	140			0-120-489-330	RB-01HA	140	VR-B196M	11
0-120-489-203	RB-01HA	140			0-120-489-332	RB-01HA	140		
0-120-489-205	RB-01HA	140	VR-B195M	11	0-120-489-333	RB-01HA	140		
0-120-489-207	RB-01HA	140	VR-B195M	11	0-120-489-339	RB-02H	140		
0-120-489-208			VR-B195M	11	0-120-489-345	RB-06HA	141		
0-120-489-209	RB-01HA	140	VR-B195M	11	0-120-489-346	RB-38H	151		
0-120-489-210	RB-03HA	140	VR-B195M	11	0-120-489-347	RB-38H	151		
0-120-489-211	RB-01HA	140	VR-B195M	11	0-120-489-348	RB-02H	140		
0-120-489-212	RB-02H	140			0-120-489-350	RB-02H	140		
0-120-489-213	RB-01HA	140			0-120-489-351	RB-02H	140		
0-120-489-214	RB-01HA	140			0-120-489-354			VR-B196M	11
0-120-489-217	RB-02H	140			0-120-489-355	RB-01HA	140	VR-B196M	11
0-120-489-218	RB-02H	140			0-120-489-356			VR-B196M	11
0-120-489-219	RB-02H	140			0-120-489-357	RB-01HA	140	VR-B196M	11
0-120-489-220	RB-02H	140			0-120-489-358	RB-02H	140	VR-B196M	11
0-120-489-221	RB-08H	141	VR-B198	12	0-120-489-359	RB-01HA	140		
0-120-489-225			VR-B198	12	0-120-489-360			VR-B195M	11
0-120-489-228			VR-B195M	11	0-120-489-361			VR-B195M	11
0-120-489-229	RB-01HA	140	VR-B195M	11	0-120-489-362	RB-05H	141	VR-B195M	11
0-120-489-230	RB-08H	141	VR-B198	12	0-120-489-363	RB-05H	141	VR-B195M	11
0-120-489-231	RB-07H	141	VR-B198	12	0-120-489-364	RB-05H	141	VR-B195M	11
0-120-489-232			VR-B196M	11	0-120-489-365	RB-05H	141	VR-B195M	11
0-120-489-233	RB-01HA	140	VR-B196M	11	0-120-489-366	RB-05H	141		
0-120-489-234	RB-01HA	140	VR-B196M	11	0-120-489-367	RB-04H	140	VR-B195M	11
0-120-489-236	RB-01HA	140			0-120-489-368	RB-04H	140		
0-120-489-237	RB-01HA	140	VR-B195M	11	0-120-489-369	RB-04H	140	VR-B195M	11
0-120-489-242			VR-B196M	11	0-120-489-370	RB-04H	140	VR-B195M	11
0-120-489-244			VR-B195M	11	0-120-489-371	RB-05H	141		
0-120-489-245	RB-06HA	141			0-120-489-372	RB-05H	141		
0-120-489-248	RB-03HA	140	VR-B195M	11	0-120-489-373	RB-05H	141		
0-120-489-249	RB-03HA	140	VR-B195M	11	0-120-489-374	RB-04H	140		
0-120-489-250	RB-03HA	140			0-120-489-376	RB-04H	140		
0-120-489-253			VR-B196M	11	0-120-489-377	RB-04H	140	VR-B195M	11
0-120-489-254	RB-02H	140	VR-B196M	11	0-120-489-378	RB-04H	140	VR-B195M	11
0-120-489-259			VR-B196M	11	0-120-489-379	RB-04H	140	VR-B195M	11
0-120-489-260	RB-01HA	140			0-120-489-380	RB-05H	141		
0-120-489-262	RB-01HA	140			0-120-489-381	RB-05H	141		
0-120-489-267	RB-06HA	141			0-120-489-382	RB-05H	141	VR-B195M	11
0-120-489-268	RB-01HA	140			0-120-489-383	RB-05H	141		
0-120-489-269	RB-01HA	140			0-120-489-386	RB-01HA	140	VR-B195M	11
0-120-489-273	RB-02H	140			0-120-489-387	RB-08H	141	VR-B194	10
0-120-489-274			VR-B196M	11	0-120-489-388	RB-08H	141		
0-120-489-275	RB-01HA	140	VR-B196M	11	0-120-489-389	RB-38H	151		
0-120-489-276	RB-01HA	140			0-120-489-392	RB-38H	151		
0-120-489-279	RB-02H	140			0-120-489-394	RB-02H	140		
0-120-489-282	RB-03HA	140	VR-B195M	11	0-120-489-395			VR-B196M	11
0-120-489-283	RB-03HA	140	VR-B195M	11	0-120-489-398	RB-01HA	140		
0-120-489-284	RB-07H	141	VR-B198	12	0-120-489-400	RB-02H	140		
0-120-489-285	RB-02H	140			0-120-489-401	RB-02H	140		
0-120-489-286	RB-16H	148	VR-B196M	11	0-120-489-403	RB-06HA	141		
0-120-489-287	RB-06HA	141	VR-B195M	11	0-120-489-404			VR-B196M	11
0-120-489-288	RB-06HA	141			0-120-489-405			VR-B196M	11
0-120-489-289	RB-01HA	140			0-120-489-408	RB-38H	151		
0-120-489-290	RB-06HA	141			0-120-489-411	RB-02H	140	VR-B203	14
0-120-489-291	RB-06HA	141			0-120-489-412	RB-02H	140	VR-B198	12
0-120-489-293	RB-01HA	140	VR-B192	9	0-120-489-413	RB-02H	140	VR-B198	12
0-120-489-294	RB-16H	148	VR-B196M	11	0-120-489-418			VR-B195M	11
0-120-489-296	RB-16H	148	VR-B195M	11	0-120-489-420			VR-B195M	11
0-120-489-297	RB-02H	140			0-120-489-421			VR-B195M	11

CROSS REFERENCE LIST

OEM Alternator No. → Mobiletron No.

OEM Alternator No.	Rectifier No.	Page	Regulator No.	Page	OEM Alternator No.	Rectifier No.	Page	Regulator No.	Page
0-120-489-422	RB-02H	140			0-120-489-561	RB-01HA	140	VR-B193M	10
0-120-489-423			VR-B195M	11	0-120-489-562	RB-01HA	140	VR-B193M	10
0-120-489-425	RB-04H	140			0-120-489-565			VR-B220	15
0-120-489-426	RB-06HA	141			0-120-489-567	RB-01HA	140	VR-B193M	10
0-120-489-427	RB-05H	141			0-120-489-568	RB-01HA	140	VR-B193M	10
0-120-489-428	RB-05H	141			0-120-489-569	RB-01HA	140	VR-B193M	10
0-120-489-429	RB-05H	141			0-120-489-571	RB-01HA	140		
0-120-489-430	RB-05H	141			0-120-489-572	RB-01HA	140		
0-120-489-431	RB-05H	141			0-120-489-573	RB-01HA	140		
0-120-489-432	RB-05H	141			0-120-489-574	RB-01HA	140		
0-120-489-433	RB-05H	141			0-120-489-575	RB-02H	140		
0-120-489-434	RB-04H	140	VR-B195M	11	0-120-489-576	RB-02H	140		
0-120-489-435	RB-04H	140			0-120-489-577	RB-02H	140		
0-120-489-436	RB-04H	140			0-120-489-578	RB-02H	140		
0-120-489-437	RB-04H	140			0-120-489-579	RB-01HA	140		
0-120-489-438	RB-04H	140			0-120-489-580	RB-01HA	140		
0-120-489-439	RB-05H	141			0-120-489-581	RB-01HA	140	VR-B193M	10
0-120-489-440	RB-05H	141			0-120-489-582	RB-01HA	140	VR-B192	9
0-120-489-441	RB-05H	141			0-120-489-585	RB-02H	140		
0-120-489-443	RB-05H	141			0-120-489-586	RB-02H	140		
0-120-489-444	RB-04H	140			0-120-489-587	RB-01HA	140	VR-B192	9
0-120-489-445	RB-04H	140			0-120-489-588	RB-01HA	140	VR-B192	9
0-120-489-446	RB-04H	140			0-120-489-589	RB-01HA	140		
0-120-489-447	RB-04H	140			0-120-489-590	RB-01HA	140	VR-B192	9
0-120-489-448	RB-05H	141	VR-B195M	11	0-120-489-592	RB-01HA	140	VR-B193M	10
0-120-489-449	RB-04H	140			0-120-489-593	RB-01HA	140	VR-B193M	10
0-120-489-450	RB-02H	140			0-120-489-594	RB-01HA	140	VR-B193M	10
0-120-489-451			VR-B196M	11	0-120-489-595	RB-01HA	140	VR-B193M	10
0-120-489-452			VR-B196M	11	0-120-489-596	RB-01HA	140		
0-120-489-455	RB-02H	140	VR-B195M	11	0-120-489-599	RB-01HA	140		
0-120-489-470	RB-03HA	140			0-120-489-600	RB-01HA	140	VR-B193M	10
0-120-489-475	RB-16H	148	VR-B192	9	0-120-489-601	RB-01HA	140	VR-B193M	10
0-120-489-480	RB-01HA	140	VR-B195M	11	0-120-489-602	RB-01HA	140	VR-B192	9
0-120-489-481	RB-16H	148	VR-B197	12	0-120-489-603	RB-01HA	140		
0-120-489-483			VR-B195M	11	0-120-489-604	RB-01HA	140		
0-120-489-484			VR-B195M	11	0-120-489-605	RB-01HA	140		
0-120-489-487	RB-02H	140			0-120-489-606	RB-02H	140	VR-B193M	10
0-120-489-495	RB-04H	140			0-120-489-607	RB-02H	140	VR-B193M	10
0-120-489-496	RB-04H	140			0-120-489-608	RB-02H	140	VR-B192	9
0-120-489-497	RB-04H	140			0-120-489-609	RB-02H	140	VR-B192	9
0-120-489-498	RB-02H	140			0-120-489-610	RB-02H	140	VR-B192	9
0-120-489-499	RB-05H	141			0-120-489-611	RB-02H	140		
0-120-489-500	RB-01HA	140	VR-B193M	10	0-120-489-613			VR-B193M	10
0-120-489-501	RB-01HA	140	VR-B192	9	0-120-489-614	RB-02H	140	VR-B193M	10
0-120-489-502	RB-01HA	140			0-120-489-615	RB-02H	140	VR-B192	9
0-120-489-503	RB-78HA	155			0-120-489-616	RB-01HA	140	VR-B193M	10
0-120-489-506	RB-01HA	140	VR-B220	15	0-120-489-617	RB-01HA	140	VR-B193M	10
0-120-489-507	RB-01HA	140			0-120-489-618			VR-B193M	10
0-120-489-508	RB-01HA	140	VR-B193M	10	0-120-489-619			VR-B193M	10
0-120-489-509	RB-01HA	140	VR-B193M	10	0-120-489-620			VR-B192	9
0-120-489-510	RB-01HA	140	VR-B193M	10	0-120-489-621			VR-B192	9
0-120-489-511	RB-01HA	140	VR-B193M	10	0-120-489-622	RB-01HA	140	VR-B192	9
0-120-489-512	RB-01HA	140			0-120-489-623	RB-01HA	140	VR-B193M	10
0-120-489-513	RB-01HA	140			0-120-489-624	RB-01HA	140	VR-B193M	10
0-120-489-514	RB-01HA	140			0-120-489-626	RB-02H	140		
0-120-489-519	RB-01HA	140	VR-B192	9	0-120-489-627	RB-02H	140	VR-B192	9
0-120-489-520	RB-01HA	140	VR-B193M	10	0-120-489-628	RB-02H	140	VR-B192	9
0-120-489-521	RB-01HA	140	VR-B192	9	0-120-489-629	RB-02H	140	VR-B192	9
0-120-489-522	RB-01HA	140			0-120-489-630	RB-02H	140	VR-B192	9
0-120-489-523	RB-01HA	140	VR-B192	9	0-120-489-631	RB-02H	140	VR-B193M	10
0-120-489-526	RB-01HA	140	VR-B193M	10	0-120-489-632	RB-02H	140	VR-B193M	10
0-120-489-527	RB-01HA	140	VR-B193M	10	0-120-489-633	RB-02H	140		
0-120-489-532	RB-01HA	140	VR-B192	9	0-120-489-634	RB-02H	140		
0-120-489-533	RB-02H	140			0-120-489-635	RB-02H	140		
0-120-489-534	RB-02H	140	VR-B192	9	0-120-489-636	RB-02H	140		
0-120-489-535	RB-01HA	140	VR-B193M	10	0-120-489-637	RB-02H	140		
0-120-489-536	RB-01HA	140			0-120-489-638	RB-02H	140	VR-B197	12
0-120-489-537	RB-02H	140			0-120-489-639	RB-02H	140	VR-B197	12
0-120-489-538	RB-02H	140			0-120-489-640	RB-02H	140	VR-B197	12
0-120-489-541			VR-B193M	10	0-120-489-641			VR-B192	9
0-120-489-542			VR-B193M	10	0-120-489-642			VR-B192	9
0-120-489-543	RB-02H	140			0-120-489-643	RB-15H	147	VR-B198	12
0-120-489-544	RB-02H	140	VR-B192	9	0-120-489-644	RB-02H	140		
0-120-489-545	RB-01HA	140			0-120-489-645	RB-02H	140		
0-120-489-546	RB-01HA	140	VR-B193M	10	0-120-489-646	RB-02H	140	VR-B193M	10
0-120-489-547	RB-01HA	140	VR-B193M	10	0-120-489-647	RB-02H	140	VR-B193M	10
0-120-489-548	RB-01HA	140	VR-B193M	10	0-120-489-648	RB-02H	140	VR-B193M	10
0-120-489-549	RB-02H	140	VR-B195M	11	0-120-489-649	RB-02H	140	VR-B192	9
0-120-489-550	RB-02H	140	VR-B192	9	0-120-489-650	RB-02H	140	VR-B192	9
0-120-489-551	RB-01HA	140			0-120-489-651	RB-02H	140	VR-B192	9
0-120-489-556	RB-01HA	140	VR-B192	9	0-120-489-652	RB-02H	140	VR-B192	9
0-120-489-557	RB-01HA	140	VR-B193M	10	0-120-489-653			VR-B193M	10
0-120-489-558	RB-01HA	140	VR-B193M	10	0-120-489-654	RB-02H	140	VR-B193M	10
0-120-489-559	RB-01HA	140	VR-B193M	10	0-120-489-655	RB-02H	140	VR-B192	9
0-120-489-560	RB-01HA	140	VR-B193M	10	0-120-489-656	RB-02H	140		

**CROSS REFERENCE
Voltage Regulator**

**CROSS REFERENCE
Rectifier**

**CROSS REFERENCE
Diode Trio**

**ALTERNATOR NO.
Reg & Rec**

CROSS REFERENCE LIST

OEM Alternator No. → Mobiletron No.

OEM Alternator No.	Rectifier No.	Page	Regulator No.	Page	OEM Alternator No.	Rectifier No.	Page	Regulator No.	Page
0-120-489-657	RB-02H	140	VR-B192	9	0-120-489-775			VR-B192	9
0-120-489-658	RB-07H	141	VR-B194	10	0-120-489-777			VR-B193M	10
0-120-489-659	RB-02H	140	VR-B193M	10	0-120-489-778			VR-B193M	10
0-120-489-660	RB-02H	140	VR-B192	9	0-120-489-779			VR-B194	10
0-120-489-661	RB-02H	140	VR-B197	12	0-120-489-781	RB-02H	140		
0-120-489-664	RB-01HA	140	VR-B193M	10	0-120-489-782			VR-B193M	10
0-120-489-665	RB-01HA	140	VR-B193M	10	0-120-489-783	RB-02H	140	VR-B193M	10
0-120-489-666	RB-01HA	140	VR-B193M	10	0-120-489-785	RB-01HA	140	VR-B193M	10
0-120-489-667	RB-01HA	140	VR-B193M	10	0-120-489-786	RB-01HA	140	VR-B193M	10
0-120-489-668	RB-02H	140	VR-B193M	10	0-120-489-788			VR-B193M	10
0-120-489-669	RB-01HA	140	VR-B193M	10	0-120-489-793	RB-02H	140	VR-B197	12
0-120-489-670	RB-01HA	140	VR-B193M	10	0-120-489-794	RB-02H	140	VR-B197	12
0-120-489-671	RB-01HA	140	VR-B193M	10	0-120-489-795	RB-02H	140	VR-B197	12
0-120-489-676	RB-01HA	140			0-120-489-796	RB-02H	140	VR-B197	12
0-120-489-678	RB-01HA	140			0-120-489-797	RB-01HA	140	VR-B193M	10
0-120-489-679	RB-01HA	140			0-120-489-798	RB-01HA	140	VR-B193M	10
0-120-489-682	RB-02H	140	VR-B197	12	0-120-489-799	RB-01HA	140		
0-120-489-683	RB-01HA	140	VR-B192	9	0-120-489-800	RB-01HA	140	VR-B193M	10
0-120-489-684	RB-08H	141	VR-B198	12	0-120-489-801	RB-01HA	140		
0-120-489-685			VR-B192	9	0-120-489-802	RB-01HA	140		
0-120-489-686	RB-02H	140	VR-B192	9	0-120-489-803	RB-01HA	140		
0-120-489-687			VR-B192	9	0-120-489-804	RB-01HA	140		
0-120-489-688	RB-02H	140			0-120-489-805	RB-01HA	140	VR-B193M	10
0-120-489-691	RB-01HA	140			0-120-489-806	RB-01HA	140	VR-B193M	10
0-120-489-692	RB-01HA	140			0-120-489-809	RB-01HA	140		
0-120-489-698	RB-01HA	140	VR-B193M	10	0-120-489-810	RB-01HA	140		
0-120-489-699	RB-01HA	140	VR-B193M	10	0-120-489-811	RB-01HA	140		
0-120-489-700	RB-01HA	140			0-120-489-812	RB-02H	140		
0-120-489-701	RB-01HA	140			0-120-489-813	RB-02H	140		
0-120-489-702	RB-08H	141	VR-B198	12	0-120-489-814	RB-01HA	140		
0-120-489-703	RB-15H	147	VR-B194	10	0-120-489-815	RB-01HA	140		
0-120-489-704	RB-07H	141	VR-B194	10	0-120-489-816	RB-01HA	140		
0-120-489-705	RB-01HA	140			0-120-489-817	RB-01HA	140		
0-120-489-706	RB-01HA	140			0-120-489-818	RB-01HA	140	VR-B192	9
0-120-489-707	RB-08H	141	VR-B198	12	0-120-489-819	RB-01HA	140	VR-B192	9
0-120-489-708			VR-B194	10	0-120-489-820	RB-01HA	140	VR-B193M	10
0-120-489-709	RB-02H	140	VR-B194	10	0-120-489-821	RB-01HA	140	VR-B193M	10
0-120-489-710	RB-08H	141	VR-B202L	14	0-120-489-822			VR-B192	9
0-120-489-711			VR-B192	9	0-120-489-823			VR-B193M	10
0-120-489-712	RB-01HA	140	VR-B192	9	0-120-489-824	RB-02H	140	VR-B193M	10
0-120-489-713			VR-B193M	10	0-120-489-826	RB-01HA	140	VR-B192	9
0-120-489-714	RB-01HA	140	VR-B193M	10	0-120-489-827	RB-07H	141	VR-B203	14
0-120-489-715			VR-B193M	10	0-120-489-828	RB-01HA	140	VR-B193M	10
0-120-489-716	RB-02H	140	VR-B193M	10	0-120-489-829	RB-01HA	140		
0-120-489-717			VR-B193M	10	0-120-489-830			VR-B192	9
0-120-489-718	RB-02H	140	VR-B193M	10	0-120-489-832			VR-B192	9
0-120-489-719	RB-01HA	140			0-120-489-833	RB-01HA	140		
0-120-489-720	RB-01HA	140	VR-B193M	10	0-120-489-834			VR-B192	9
0-120-489-721	RB-01HA	140			0-120-489-835	RB-01HA	140	VR-B192	9
0-120-489-722	RB-01HA	140			0-120-489-836	RB-02H	140		
0-120-489-723	RB-08H	141	VR-B194	10	0-120-489-837	RB-02H	140		
0-120-489-724	RB-07H	141	VR-B194	10	0-120-489-839	RB-01HA	140		
0-120-489-725	RB-08H	141	VR-B194	10	0-120-489-840	RB-01HA	140		
0-120-489-726	RB-08H	141	VR-B194	10	0-120-489-841			VR-B193M	10
0-120-489-727	RB-08H	141	VR-B198	12	0-120-489-842	RB-01HA	140		
0-120-489-728	RB-07H	141	VR-B210	15	0-120-489-843	RB-01HA	140	VR-B193M	10
0-120-489-729			VR-B194	10	0-120-489-844	RB-01HA	140	VR-B193M	10
0-120-489-730	RB-07H	141	VR-B198	12	0-120-489-846	RB-01HA	140		
0-120-489-731	RB-07H	141	VR-B210	15	0-120-489-847	RB-01HA	140		
0-120-489-732	RB-01HA	140	VR-B193M	10	0-120-489-848	RB-01HA	140		
0-120-489-733	RB-08H	141	VR-B198	12	0-120-489-849	RB-01HA	140	VR-B193M	10
0-120-489-735	RB-02H	140	VR-B192	9	0-120-489-850	RB-01HA	140	VR-B193M	10
0-120-489-737	RB-02H	140	VR-B194	10	0-120-489-851	RB-01HA	140		
0-120-489-739	RB-02H	140			0-120-489-853	RB-01HA	140		
0-120-489-742			VR-B192	9	0-120-489-854	RB-01HA	140		
0-120-489-743			VR-B193M	10	0-120-489-855	RB-01HA	140		
0-120-489-744	RB-01HA	140	VR-B193M	10	0-120-489-856	RB-01HA	140		
0-120-489-745	RB-01HA	140	VR-B193M	10	0-120-489-857	RB-01HA	140	VR-B193M	10
0-120-489-746	RB-01HA	140	VR-B193M	10	0-120-489-858			VR-B193M	10
0-120-489-747	RB-01HA	140	VR-B193M	10	0-120-489-859	RB-01HA	140	VR-B193M	10
0-120-489-748	RB-01HA	140	VR-B193M	10	0-120-489-860	RB-01HA	140	VR-B192	9
0-120-489-749	RB-01HA	140	VR-B193M	10	0-120-489-862	RB-01HA	140		
0-120-489-751	RB-01HA	140	VR-B192	9	0-120-489-864	RB-01HA	140	VR-B192	9
0-120-489-753			VR-B193M	10	0-120-489-865			VR-B193M	10
0-120-489-755	RB-01HA	140	VR-B193M	10	0-120-489-866	RB-01HA	140	VR-B193M	10
0-120-489-756	RB-08H	141	VR-B202L	14	0-120-489-867	RB-01HA	140	VR-B192	9
0-120-489-757	RB-08H	141	VR-B194	10	0-120-489-868			VR-B193M	10
0-120-489-758	RB-01HA	140	VR-B193M	10	0-120-489-869	RB-01HA	140	VR-B193M	10
0-120-489-766	RB-02H	140			0-120-489-870			VR-B193M	10
0-120-489-767	RB-02H	140			0-120-489-871	RB-01HA	140	VR-B193M	10
0-120-489-768	RB-02H	140			0-120-489-872			VR-B193M	10
0-120-489-769	RB-02H	140			0-120-489-873	RB-01HA	140	VR-B193M	10
0-120-489-771			VR-B193M	10	0-120-489-874			VR-B192	9
0-120-489-772	RB-01HA	140	VR-B193M	10	0-120-489-875	RB-02H	140	VR-B192	9
0-120-489-774	RB-01HA	140	VR-B193M	10	0-120-489-876			VR-B192	9

CROSS REFERENCE LIST

OEM Alternator No. → Mobiletron No.

OEM Alternator No.	Rectifier No.	Page	Regulator No.	Page	OEM Alternator No.	Rectifier No.	Page	Regulator No.	Page
0-120-489-877	RB-02H	140	VR-B192	9	0-120-496-617	RB-55H	153		
0-120-489-878	RB-01HA	140			0-120-496-777	RB-54H	153		
0-120-489-879	RB-02H	140			0-120-505-005			VR-B200H	13
0-120-489-880	RB-02H	140			0-120-505-010	RB-78HA	155		
0-120-489-881			VR-B196M	11	0-120-510-053	RB-107H	142		
0-120-489-882	RB-02H	140	VR-B196M	11	0-120-510-054	RB-107H	142		
0-120-489-885	RB-07H	141	VR-B198	12	0-120-510-056	RB-107H	142		
0-120-489-886	RB-07H	141	VR-B210	15	0-120-510-065	RB-107H	142		
0-120-489-887	RB-01HA	140			0-120-515-016	RB-107H	142		
0-120-489-888			VR-B195M	11	0-120-623-052			VR-B198	12
0-120-489-889	RB-01HA	140	VR-B195M	11	0-120-689-502			VR-B198	12
0-120-489-891			VR-B194	10	0-120-689-503	RB-78HA	155	VR-B206	14
0-120-489-892			VR-B193M	10	0-120-689-504	RB-78HA	155	VR-B198	12
0-120-489-893	RB-01HA	140	VR-B193M	10	0-120-689-505	RB-78HA	155	VR-B198	12
0-120-489-896	RB-01HA	140	VR-B193M	10	0-120-689-506	RB-78HA	155	VR-B198	12
0-120-489-897	RB-01HA	140	VR-B192	9	0-120-689-507	RB-78HA	155	VR-B198	12
0-120-489-898	RB-01HA	140	VR-B192	9	0-120-689-508	RB-78HA	155	VR-B198	12
0-120-489-900	RB-07H	141	VR-B194	10	0-120-689-510	RB-78HA	155	VR-B198	12
0-120-489-902	RB-07H	141	VR-B194	10	0-120-689-511	RB-78HA	155	VR-B198	12
0-120-489-903			VR-B195M	11	0-120-689-512	RB-78HA	155	VR-B206	14
0-120-489-904	RB-02H	140	VR-B195M	11	0-120-689-513	RB-78HA	155	VR-B198	12
0-120-489-905			VR-B195M	11	0-120-689-514	RB-78HA	155	VR-B198	12
0-120-489-906	RB-02H	140	VR-B195M	11	0-120-689-515	RB-78HA	155	VR-B206	14
0-120-489-910	RB-01HA	140			0-120-689-516	RB-78HA	155	VR-B198	12
0-120-489-912	RB-01HA	140			0-120-689-517	RB-78HA	155	VR-B198	12
0-120-489-913			VR-B193M	10	0-120-689-520	RB-78HA	155	VR-B198	12
0-120-489-914	RB-01HA	140	VR-B193M	10	0-120-689-521	RB-78HA	155	VR-B198	12
0-120-489-915	RB-01HA	140	VR-B193M	10	0-120-689-522	RB-78HA	155	VR-B198	12
0-120-489-916	RB-01HA	140	VR-B193M	10	0-120-689-523	RB-78HA	155	VR-B198	12
0-120-489-917			VR-B196M	11	0-120-689-524	RB-78HA	155		
0-120-489-918	RB-01HA	140	VR-B196M	11	0-120-689-525	RB-78HA	155	VR-B198	12
0-120-489-919	RB-01HA	140			0-120-689-526	RB-78HA	155	VR-B198	12
0-120-489-928	RB-01HA	140	VR-B196M	11	0-120-689-527	RB-78HA	155	VR-B198	12
0-120-489-930	RB-01HA	140	VR-B196M	11	0-120-689-528	RB-78HA	155	VR-B198	12
0-120-489-931	RB-01HA	140			0-120-689-530	RB-78HA	155		
0-120-489-932	RB-01HA	140	VR-B196M	11	0-120-689-532	RB-78HA	155		
0-120-489-933	RB-01HA	140	VR-B196M	11	0-120-689-533	RB-78H	155		
0-120-489-935			VR-B196M	11	0-120-689-534	RB-78H	155		
0-120-489-936	RB-01HA	140	VR-B196M	11	0-120-689-535	RB-78H	155		
0-120-489-937			VR-B193M	10	0-120-689-538	RB-78H	155		
0-120-489-938	RB-01HA	140	VR-B193M	10	0-120-689-539	RB-78H	155		
0-120-489-942			VR-B193M	10	0-120-689-540	RB-78H	155		
0-120-489-943	RB-02H	140	VR-B193M	10	0-120-689-541	RB-78H	155		
0-120-489-944	RB-07H	141	VR-B203	14	0-120-689-542	RB-78H	155		
0-120-489-948	RB-02H	140			0-120-689-543	RB-78H	155		
0-120-489-949	RB-02H	140			0-120-689-545	RB-78H	155		
0-120-489-951	RB-02H	140			0-120-689-546	RB-78H	155		
0-120-489-952	RB-02H	140			0-120-689-549	RB-78H	155		
0-120-489-955	RB-02H	140	VR-B192	9	0-120-689-550	RB-78H	155		
0-120-489-956	RB-06HA	141			0-120-689-551	RB-78H	155		
0-120-489-957	RB-06HA	141	VR-B192	9	0-120-689-552	RB-78H	155		
0-120-489-958	RB-06HA	141			0-120-689-553	RB-78H	155		
0-120-489-959	RB-06HA	141			0-120-689-555	RB-78H	155		
0-120-489-960	RB-03HA	140			0-120-689-557	RB-78H	155		
0-120-489-961	RB-03HA	140	VR-B195M	11	0-120-689-558	RB-78H	155		
0-120-489-965	RB-01HA	140			0-120-689-559	RB-78H	155		
0-120-489-966	RB-03HA	140	VR-B195M	11	0-120-689-561	RB-78H	155		
0-120-489-967	RB-03HA	140	VR-B195M	11	0-120-689-562	RB-78H	155		
0-120-489-968	RB-03HA	140	VR-B195M	11	0-120-689-563	RB-78H	155		
0-120-489-969	RB-03HA	140			0-120-689-564	RB-78H	155		
0-120-489-971	RB-03HA	140	VR-B196M	11	0-120-689-566	RB-78H	155		
0-120-489-972	RB-03HA	140	VR-B196M	11	0-120-689-567	RB-78H	155		
0-120-489-973	RB-03HA	140			0-120-689-569	RB-78H	155		
0-120-489-974	RB-03HA	140	VR-B196M	11	0-120-689-570	RB-78H	155		
0-120-489-975	RB-03HA	140	VR-B196M	11	0-120-689-571	RB-78H	155		
0-120-489-976	RB-03HA	140	VR-B195M	11	0-120-689-572	RB-78H	155		
0-120-489-977	RB-03HA	140			0-120-689-573	RB-78H	155		
0-120-489-978	RB-03HA	140			0-120-689-574	RB-78H	155		
0-120-489-979	RB-03HA	140			0-120-689-575	RB-78H	155		
0-120-489-980	RB-03HA	140	VR-B195M	11	0-120-689-576	RB-78H	155		
0-120-489-981	RB-03HA	140	VR-B195M	11	0-120-689-577	RB-78H	155		
0-120-489-982			VR-B195M	11	0-120-689-582	RB-78H	155		
0-120-489-983	RB-01HA	140	VR-B195M	11	0-120-689-583	RB-78H	155		
0-120-489-986			VR-B195M	11	0-120-689-584	RB-78H	155		
0-120-489-987	RB-01HA	140	VR-B195M	11	0-120-689-623	RB-78HA	155		
0-120-489-988	RB-01HA	140			0121541002	RB-117H	143		
0-120-489-989	RB-01HA	140			0121541102	RB-117H	143		
0-120-489-991	RB-01HA	140			0121541502			VR-B264	19
0-120-489-992			VR-B195M	11	0121541702			VR-B363	22
0-120-489-993	RB-01HA	140	VR-B195M	11	0121542002			VR-B264	19
0-120-489-994	RB-07H	141			0121542202			VR-B363	22
0-120-489-995	RB-07H	141	VR-B194	10	0121542402			VR-B264	19
0-120-489-996	RB-07H	141	VR-B194	10	0121544602			VR-B264	19
0-120-489-997	RB-01HA	140	VR-B196M	11	0121549902			VR-B132	7
0-120-489-999			VR-B204	14	0-121-615-001			VR-B026	4

CROSS REFERENCE
Voltage Regulator

CROSS REFERENCE
Rectifier

CROSS REFERENCE
Diode Trio

ALTERNATOR NO.
Reg & Rec

CROSS REFERENCE LIST

OEM Alternator No. → Mobiletron No.

	OEM Alternator No.	Rectifier No.	Page	Regulator No.	Page	OEM Alternator No.	Rectifier No.	Page	Regulator No.	Page
CROSS REFERENCE Voltage Regulator	0-121-615-002			VR-B026	4	0-123-315-002	RB-122H	144	VR-B200H	13
	0-121-615-003			VR-B026	4	0-123-315-003			VR-B200H	13
	0-121-615-005			VR-B056	5	0-123-315-005	RB-121H	144	VR-B201H	13
	0-121-615-006			VR-B056	5	0-123-315-006			VR-B200H	13
	0-121-615-007			VR-B056	5	0-123-315-007			VR-B225	16
	0-121-615-008			VR-B056	5	0-123-315-013			VR-B238	16
	0-121-615-009			VR-B056	5	0-123-315-016			VR-B229	16
	0-121-615-010			VR-B088	5	0-123-315-020	RB-134H	145	VR-B225	16
	0-121-615-011			VR-B057	5	0-123-315-021			VR-B229	16
	0-121-615-012			VR-B066	5	0-123-315-500	RB-134H	145		
CROSS REFERENCE Rectifier	0-121-615-013			VR-B029	4	0-123-320-001	RB-24H	151		
	0-121-615-014			VR-B056	5	0-123-320-002	RB-24H	151		
	0-121-615-021			VR-B056	5	0-123-320-003	RB-30H	151		
	0-121-615-027			VR-B066	5	0-123-320-005	RB-24H	151		
	0-121-615-028			VR-B056	5	0-123-320-012	RB-101H	141		
	0-121-615-029			VR-B029	4	0-123-320-014	RB-160H	147		
	0-121-615-127			VR-B066	5	0-123-320-017	RB-122H	144		
	0-121-651-044			VR-B066	5	0-123-320-019	RB-122H	144		
	0-121-715-001			VR-B340	22	0-123-320-029	RB-121H	144		
	0-121-715-002			VR-B056	5	0-123-320-030	RB-134H	145		
CROSS REFERENCE Diode Trio	0-121-715-003			VR-B137	7	0-123-320-040			VR-B261	18
	0-121-715-004			VR-B029	4	0-123-320-044	RB-121H	144		
	0-121-715-006			VR-B021	4	0-123-320-045	RB-121H	144		
	0-121-715-007			VR-B021	4	0123320046			VR-B261	18
	0-121-715-008			VR-B056	5	0123320047			VR-B261	18
	0-121-715-009			VR-B057	5	0123320049			VR-B261	18
	0-121-715-012			VR-B033	4	0-123-320-050	RB-105H	142		
	0-121-715-014			VR-B021	4	0123320051			VR-B261	18
	0-121-715-015			VR-B021	4	0123320058			VR-B261	18
	0-121-715-016			VR-B033	4	0123320060			VR-B261	18
ALTERNATOR NO. Reg & Rec	0-121-715-017			VR-B033	4	0123320061			VR-B261	18
	0-121-715-018			VR-B033	4	0123320062			VR-B261	18
	0-121-715-024			VR-B056	5	0-123-325-002			VR-B510	24
	0-121-715-029			VR-B021	4	0-123-325-005			VR-B222	16
	0-121-715-032			VR-B056	5	0-123-325-006			VR-B222	16
	0-121-715-049			VR-B092	6	0-123-325-010			VR-B238	16
	0-121-715-050			VR-B092	6	0-123-325-012			VR-B510	24
	0-121-715-051			VR-B092	6	0-123-325-014			VR-B510	24
	0-121-715-071			VR-B092	6	0-123-325-500			VR-B558B	24
	0-121-715-076			VR-B092	6	0-123-340-001	RB-30H	151		
	0-121-715-077			VR-B092	6	0-123-340-002	RB-24H	151	VR-B200H	13
	0-121-715-078			VR-B092	6	0-123-340-003	RB-24H	151	VR-B200H	13
	0-121-715-080			VR-B092	6	0-123-340-005	RB-24H	151	VR-B200H	13
	0-121-715-101			VR-B340	22	0123340007			VR-B261	18
	0-121-715-112			VR-B033	4	0-123-505-001	RB-33H	151		
	0-121-715-116			VR-B033	4	0-123-505-010			VR-B200H	13
	0-121-715-118			VR-B033	4	0-123-505-011			VR-B222	16
	0-121-715-171			VR-B092	6	0-123-505-012			VR-B222	16
	0-121-715-176			VR-B092	6	0-123-505-013			VR-B222	16
	0-121-813-001			VR-B020	4	0-123-505-014			VR-B229	16
	0-121-813-002			VR-B020	4	0-123-505-015			VR-B229	16
	0-121-813-003			VR-B020	4	0-123-505-016			VR-B229	16
	0-121-813-005			VR-B020	4	0-123-505-017			VR-B235	16
	0-121-813-006			VR-B020	4	0-123-510-001			VR-B200H	13
	0-121-813-014			VR-B020	4	0-123-510-003	RB-33H	151		
	0-121-813-020			VR-B020	4	0-123-510-004	RB-108H	142		
	0-122-0AA-090			VR-B5204	24	0-123-510-007			VR-B235	16
	0-122-0AA-0B0			VR-B257	18	0-123-510-008			VR-B235	16
	0-122-0AA-2A0			VR-B257	18	0-123-510-017	RB-49H	152	VR-B208H	14
	0-122-468-015	RB-170HD	148	VR-B394	23	0-123-510-018	RB-108H	142		
	0-122-500-076			VR-B257	18	0-123-510-020	RB-33H	151		
	0-123-100-001	RB-37H	151			0-123-510-021	RB-108H	142		
	0-123-100-002	RB-37H	151			0-123-510-023	RB-110H	142		
	0-123-110-005	RB-32H	151			0-123-510-028			VR-B235	16
	0-123-120-001	RB-32H	151	VR-B200H	13	0-123-510-031	RB-110H	142		
	0-123-212-001	RB-26H	151			0-123-510-033	RB-110H	142		
	0-123-213-007			VR-B201H	13	0-123-510-038	RB-110H	142		
	0-123-214-002			VR-B200H	13	0-123-510-039	RB-110H	142		
	0-123-310-001			VR-B200H	13	0-123-510-041	RB-110H	142		
	0-123-310-002	RB-122H	144	VR-B200H	13	0-123-510-044	RB-110H	142		
	0-123-310-003	RB-122H	144			0-123-510-045	RB-110H	142		
	0-123-310-010	RB-36H	151	VR-B240H	16	0-123-510-046			VR-B222	16
	0-123-310-011	RB-36H	151	VR-B240H	16	0-123-510-047			VR-B222	16
	0-123-310-012	RB-36H	151	VR-B240H	16	0-123-510-049	RB-110H	142		
	0-123-310-013	RB-36H	151	VR-B240H	16	0-123-510-050	RB-110H	142		
	0-123-310-014	RB-160H	147			0-123-510-051	RB-110H	142		
	0-123-310-015	RB-160H	147			0-123-510-052	RB-33H	151		
	0-123-310-024	RB-122H	144			0-123-510-058	RB-110H	142		
	0-123-310-025	RB-122H	144			0-123-510-059	RB-110H	142		
	0-123-310-029	RB-160H	147			0-123-510-060	RB-108H	142		
	0-123-310-032	RB-122H	144			0-123-510-061	RB-110H	142		
	0-123-310-042	RB-134H	145			0-123-510-062			VR-B200H	13
	0-123-310-051			VR-B240H	16	0-123-510-066	RB-110H	142		
	0-123-310-053	RB-160H	147			0-123-510-067	RB-110H	142		
	0-123-315-001			VR-B200H	13	0-123-510-070	RB-110H	142		

CROSS REFERENCE LIST

OEM Alternator No. → Mobiletron No.

OEM Alternator No.	Rectifier No.	Page	Regulator No.	Page	OEM Alternator No.	Rectifier No.	Page	Regulator No.	Page
0-123-510-072	RB-110H	142			0-124-315-025			VR-B243	16
0-123-510-074	RB-108H	142			0-124-315-027			VR-B262	19
0-123-510-075	RB-108H	142			0-124-315-029			VR-B243	16
0-123-510-080	RB-110H	142			0-124-315-031			VR-B296	21
0-123-510-088	RB-110H	142			0-124-315-032			VR-B296	21
0-123-510-091	RB-110H	142			0-124-315-033			VR-B243	16
0-123-512-500	RB-110H	142			0-124-315-034			VR-B243	16
0-123-515-002			VR-B238	16	0-124-315-036			VR-B296	21
0-123-515-003			VR-B235	16	0-124-315-037			VR-B300	21
0-123-515-003	RB-110H	142			0-124-315-040			VR-B243	16
0-123-515-004			VR-B238	16	0-124-320-001	RB-116H	143		
0-123-515-007			VR-B238	16	0-124-325-001	RB-116H	143		
0-123-515-008			VR-B235	16	0-124-325-002	RB-116H	143		
0-123-515-008	RB-110H	142			0-124-325-003	RB-116H	143		
0-123-515-009			VR-B235	16	0-124-325-004	RB-116H	143		
0-123-515-009	RB-110H	142			0-124-325-006	RB-113H	143	VR-B255	18
0-123-515-010			VR-B238	16	0-124-325-007	RB-113H	143	VR-B255	18
0-123-515-011			VR-B235	16	0-124-325-008			VR-B267	19
0-123-515-011	RB-110H	142			0-124-325-009			VR-B256	18
0-123-515-012			VR-B235	16	0-124-325-010			VR-B267	19
0-123-515-012	RB-110H	142			0-124-325-011	RB-116H	143	VR-B255	18
0-123-515-014			VR-B222	16	0-124-325-012	RB-116H	143		
0-123-515-017			VR-B222	16	0-124-325-019			VR-B271	20
0-123-515-018			VR-B222	16	0-124-325-023			VR-B252	17
0-123-515-020			VR-B222	16	0-124-325-024	RB-113H	143	VR-B251	17
0-123-515-021			VR-B222	16	0-124-325-028			VR-B256	18
0-123-515-022			VR-B238	16	0-124-325-039			VR-B264	19
0-123-515-023			VR-B238	16	0-124-325-040			VR-B861	26
0-123-515-024			VR-B235	16	0-124-325-044			VR-B296	21
0-123-515-024	RB-110H	142			0-124-325-045			VR-B247	17
0-123-515-025			VR-B238	16	0-124-325-046			VR-B264	19
0-123-515-030			VR-B238	16	0-124-325-050	RB-926H	156		
0-123-520-002	RB-112H	142			0-124-325-051	RB-926H	156		
0-123-520-003			VR-B235	16	0-124-325-054			VR-B252	17
0-123-520-004			VR-B235	16	0-124-325-055			VR-B252	17
0-123-520-005	RB-112H	142			0-124-325-061			VR-B296	21
0-123-525-500			VR-B543B	24	0-124-325-063			VR-B253	17
0-123-525-501			VR-B558B	24	0-124-325-064	RB-161H	147	VR-B253	17
0-123-525-502			VR-B543B	24	0-124-325-066	RB-172H	148	VR-B296	21
0-123-545-003			VR-B208H	14	0-124-325-067			VR-B296	21
0-124-215-001			VR-B256	18	0-124-325-071			VR-B243	16
0-124-215-002			VR-B256	18	0-124-325-073			VR-B296	21
0-124-215-003			VR-B252	17	0-124-325-076	RB-172H	148	VR-B296	21
0-124-215-005			VR-B256	18	0-124-325-077			VR-B414	24
0-124-215-006			VR-B254	17	0-124-325-079			VR-B243	16
0-124-215-008			VR-B296	21	0-124-325-081			VR-B296	21
0-124-215-009			VR-B296	21	0-124-325-083			VR-B296	21
0-124-225-001	RB-118H	143	VR-B252	17	0-124-325-085			VR-B243	16
0-124-225-002	RB-118H	143	VR-B252	17	0-124-325-086			VR-B243	16
0-124-225-004	RB-118H	143	VR-B252	17	0-124-325-087	RB-188H	149		
0-124-225-009	RB-118H	143	VR-B252	17	0-124-325-088			VR-B296	21
0-124-225-010	RB-116H	143			0-124-325-093			VR-B264	19
0-124-225-012			VR-B254	17	0-124-325-095			VR-B296	21
0-124-225-016			VR-B256	18	0-124-325-096			VR-B296	21
0-124-225-018			VR-B252	17	0-124-325-097			VR-B296	21
0-124-225-020			VR-B244	17	0-124-325-100			VR-B262	19
0-124-225-022			VR-B252	17	0-124-325-105			VR-B264	19
0-124-225-023	RB-118H	143	VR-B252	17	0-124-325-108			VR-B247	17
0-124-225-024	RB-118H	143	VR-B252	17	0-124-325-116	RB-188H	149		
0-124-225-025	RB-118H	143	VR-B252	17	0-124-325-117			VR-B221	15
0-124-225-026	RB-118H	143	VR-B256	18	0-124-325-121	RB-167HV	147		
0-124-225-027	RB-118H	143	VR-B256	18	0-124-325-123			VR-B243	16
0-124-225-051	RB-190H	150			0-124-325-125			VR-B296	21
0-124-225-053			VR-B243	16	0-124-325-126			VR-B300	21
0-124-225-054	RB-172H	148			0-124-325-127			VR-B300	21
0-124-225-055	RB-190H	150			0-124-325-128			VR-B300	21
0-124-315-001	RB-116H	143	VR-B254	17	0-124-325-129			VR-B300	21
0-124-315-002	RB-116H	143	VR-B254	17	0-124-325-130			VR-B300	21
0-124-315-003	RB-116H	143	VR-B254	17	0-124-325-131			VR-B296	21
0-124-315-004	RB-116H	143	VR-B254	17	0-124-325-132			VR-B296	21
0-124-315-005	RB-116H	143	VR-B254	17	0-124-325-133	RB-179HV	148		
0-124-315-006	RB-116H	143	VR-B254	17	0-124-325-134	RB-194H	150	VR-B330	22
0-124-315-007	RB-116H	143	VR-B254	17	0-124-325-138			VR-B296	21
0-124-315-008	RB-116H	143	VR-B254	17	0-124-325-140			VR-B296	21
0-124-315-010	RB-116H	143			0-124-325-141			VR-B300	21
0-124-315-011	RB-116H	143	VR-B254	17	0-124-325-142			VR-B300	21
0-124-315-012			VR-B254	17	0-124-325-153	RB-167HV	147		
0-124-315-013	RB-116H	143	VR-B254	17	0-124-325-158			VR-B247	17
0-124-315-014	RB-116H	143			0-124-325-160			VR-B300	21
0-124-315-015			VR-B243	16	0-124-325-163			VR-B160	8
0-124-315-016			VR-B243	16	0-124-325-165			VR-B243	16
0-124-315-018			VR-B254	17	0-124-325-166	RB-188H	149		
0-124-315-019			VR-B262	19	0-124-325-170			VR-B150	7
0-124-315-020			VR-B254	17	0-124-325-171			VR-B160	8
0-124-315-024			VR-B243	16	0-124-325-172			VR-B160	8

**CROSS REFERENCE
Voltage Regulator**

**CROSS REFERENCE
Rectifier**

**CROSS REFERENCE
Diode Trio**

**ALTERNATOR NO.
Reg & Rec**

CROSS REFERENCE LIST

OEM Alternator No. → Mobiletron No.

	OEM Alternator No.	Rectifier No.	Page	Regulator No.	Page	OEM Alternator No.	Rectifier No.	Page	Regulator No.	Page
CROSS REFERENCE Voltage Regulator	0-124-325-221			VR-B160	8	0-124-515-027	RB-119H	143		
	0-124-355-001			VR-B396	24	0-124-515-028	RB-163H	147	VR-B271	20
	0-124-355-002			VR-B396	24	0-124-515-031			VR-B252	17
	0-124-415-001	RB-115H	143	VR-B252	17	0-124-515-032			VR-B371	22
	0-124-415-002	RB-115H	143	VR-B252	17	0-124-515-033			VR-B371	22
	0-124-415-005	RB-115H	143	VR-B252	17	0-124-515-034	RB-119H	143		
	0-124-415-006	RB-115H	143	VR-B253	17	0-124-515-038	RB-119H	143		
	0-124-415-007			VR-B251	17	0-124-515-039	RB-119H	143		
	0-124-415-008	RB-115H	143	VR-B252	17	0-124-515-040	RB-163H	147	VR-B296	21
	0-124-415-009	RB-115H	143	VR-B371	22	0-124-515-041			VR-B267	19
CROSS REFERENCE Rectifier	0-124-415-010	RB-115H	143	VR-B252	17	0-124-515-043			VR-B265	19
	0-124-415-011			VR-B256	18	0-124-515-047			VR-B861	26
	0-124-415-012			VR-B256	18	0-124-515-048			VR-B247	17
	0-124-415-013			VR-B251	17	0-124-515-050	RB-168H	147	VR-B360	22
	0-124-415-014			VR-B251	17	0-124-515-051			VR-B880	27
	0-124-415-016			VR-B262	19	0-124-515-054	RB-119H	143	VR-B221	15
	0-124-415-025			VR-B371	22	0-124-515-055			VR-B861	26
	0-124-415-029			VR-B262	19	0-124-515-059			VR-B296	21
	0-124-415-030			VR-B262	19	0-124-515-060			VR-B247	17
	0-124-415-031			VR-B262	19	0-124-515-061			VR-B264	19
CROSS REFERENCE Diode Trio	0-124-415-032			VR-B262	19	0-124-515-064			VR-B264	19
	0-124-425-001	RB-180HV	149	VR-B280	20	0-124-515-068			VR-B296	21
	0-124-425-004			VR-B371	22	0-124-515-091			VR-B264	19
	0-124-425-007			VR-B314	21	0-124-515-095			VR-B371	22
	0-124-425-008			VR-B314	21	0-124-515-096			VR-B371	22
	0-124-425-011			VR-B131	7	0-124-515-097	RB-168H	147		
	0-124-425-013			VR-B131	7	0-124-515-098			VR-B880	27
	0-124-425-018			VR-B131	7	0-124-515-099			VR-B252	17
	0-124-425-019			VR-B371	22	0-124-515-100			VR-B252	17
	0-124-425-029			VR-B131	7	0-124-515-103			VR-B296	21
ALTERNATOR NO. Reg & Rec	0-124-425-030			VR-B314	21	0-124-515-105			VR-B280	20
	0-124-425-031			VR-B372	22	0-124-515-114			VR-B264	19
	0-124-425-032			VR-B314	21	0-124-515-117			VR-B296	21
	0-124-425-033			VR-B372	22	0-124-515-118			VR-B264	19
	0-124-425-034			VR-B131	7	0-124-515-122			VR-B296	21
	0-124-425-037			VR-B131	7	0-124-515-125			VR-B296	21
	0-124-425-038			VR-B131	7	0-124-515-131			VR-B861	26
	0-124-425-039			VR-B131	7	0-124-515-198	RB-163H	147	VR-B385	23
	0-124-425-040			VR-B372	22	0-124-525-001			VR-B221	15
	0-124-425-042			VR-B131	7	0-124-525-002	RB-171HV	148		
0-124-425-045			VR-B131	7	0-124-525-003	RB-171HV	148			
0-124-425-046			VR-B131	7	0-124-525-004	RB-180HV	149			
0-124-425-047			VR-B131	7	0-124-525-005	RB-180HV	149			
0-124-425-048			VR-B371	22	0-124-525-006	RB-171HV	148			
0-124-425-049			VR-B314	21	0-124-525-007	RB-171HV	148			
0-124-425-050			VR-B160	8	0-124-525-008			VR-B296	21	
0-124-425-056			VR-B372	22	0-124-525-010			VR-B296	21	
0-124-425-057			VR-B160	8	0-124-525-014			VR-B221	15	
0-124-425-058			VR-B160	8	0-124-525-016			VR-B266	19	
0-124-425-059			VR-B160	8	0-124-525-021			VR-B262	19	
0-124-425-060			VR-B160	8	0-124-525-026	RB-175HD	148	VR-B278	20	
0-124-425-063			VR-B314	21	0-124-525-028			VR-B242	16	
0-124-425-064			VR-B314	21	0-124-525-029			VR-B221	15	
0-124-425-069			VR-B131	7	0-124-525-031			VR-B371	22	
0-124-425-070			VR-B131	7	0-124-525-035			VR-B270	20	
0-124-425-071			VR-B131	7	0-124-525-041	RB-180HV	149			
0-124-425-074			VR-B131	7	0-124-525-042			VR-B285	21	
0-124-425-075			VR-B131	7	0-124-525-043			VR-B242	16	
0-124-425-084			VR-B160	8	0-124-525-044			VR-B242	16	
0-124-425-085			VR-B160	8	0-124-525-045			VR-B880	27	
0-124-425-086			VR-B160	8	0-124-525-047			VR-B242	16	
0-124-425-087			VR-B160	8	0-124-525-048			VR-B880	27	
0-124-425-096			VR-B160	8	0-124-525-049			VR-B295	21	
0-124-425-097			VR-B160	8	0-124-525-050			VR-B296	21	
0-124-485-020	RB-30H	151			0-124-525-054	RB-181HD	149	VR-B885	27	
0-124-485-023	RB-30H	151			0-124-525-055	RB-181HD	149	VR-B885	27	
0-124-512-013	RB-119H	143			0-124-525-058			VR-B372	22	
0-124-515-004			VR-B252	17	0-124-525-059	RB-174HD	148	VR-B880	27	
0-124-515-005			VR-B252	17	0-124-525-061			VR-B379	23	
0-124-515-006			VR-B252	17	0-124-525-062			VR-B300	21	
0-124-515-008			VR-B265	19	0-124-525-063	RB-174HD	148	VR-B322	22	
0-124-515-010	RB-119H	143			0-124-525-066			VR-B300	21	
0-124-515-011	RB-119H	143			0-124-525-067			VR-B296	21	
0-124-515-012	RB-119H	143	VR-B414	24	0-124-525-070			VR-B242	16	
0-124-515-016			VR-B372	22	0-124-525-072	RB-954H	157	VR-B314	21	
0-124-515-017	RB-119H	143	VR-B221	15	0-124-525-074			VR-B300	21	
0-124-515-018			VR-B221	15	0-124-525-076			VR-B242	16	
0-124-515-019	RB-119H	143	VR-B221	15	0-124-525-082			VR-B242	16	
0-124-515-020	RB-119H	143	VR-B255	18	0-124-525-083			VR-B657	25	
0-124-515-021			VR-B255	18	0-124-525-084			VR-B295	21	
0-124-515-022	RB-119H	143			0-124-525-085			VR-B264	19	
0-124-515-023			VR-B252	17	0-124-525-086			VR-B372	22	
0-124-515-024	RB-119H	143			0-124-525-087			VR-B296	21	
0-124-515-025	RB-119H	143			0-124-525-088			VR-B300	21	
0-124-515-026	RB-119H	143			0-124-525-089			VR-B296	21	

CROSS REFERENCE LIST

OEM Alternator No. → Mobiletron No.

OEM Alternator No.	Rectifier No.	Page	Regulator No.	Page	OEM Alternator No.	Rectifier No.	Page	Regulator No.	Page
0-124-525-090			VR-B296	21	0-124-625-019			VR-B883	27
0-124-525-091			VR-B300	21	0-124-625-020	RB-166H	147	VR-B264	19
0-124-525-092			VR-B296	21	0-124-625-022	RB-166H	147		
0-124-525-095			VR-B296	21	0-124-625-023			VR-B378	23
0-124-525-097			VR-B372	22	0-124-625-024	RB-166H	147	VR-B379	23
0-124-525-104			VR-B314	21	0-124-625-025	RB-166H	147	VR-B379	23
0-124-525-105	RB-180HV	149			0-124-625-026	RB-166H	147	VR-B280	20
0-124-525-109			VR-B363	22	0-124-625-028	RB-166H	147	VR-B296	21
0-124-525-113			VR-B4197	24	0-124-625-045			VR-B132	7
0-124-525-135			VR-B295	21	0-124-625-059			VR-B252	17
0-124-525-141			VR-B295	21	0-124-625-105			VR-B252	17
0-124-525-161			VR-B883	27	0-124-625-123			VR-B252	17
0-124-525-186			VR-B252	17	0-124-655-001	RB-117H	143	VR-B396	24
0-124-525-195			VR-B885	27	0-124-655-002	RB-117H	143	VR-B396	24
0-124-525-200			VR-B4197	24	0-124-655-003			VR-B118B	6
0-124-555-001	RB-117H	143	VR-B396	24	0-124-655-004	RB-117H	143	VR-B396	24
0-124-555-002	RB-117H	143	VR-B396	24	0-124-655-005			VR-B268	20
0-124-555-003			VR-B118B	6	0-124-655-006			VR-B268	20
0-124-555-004	RB-117H	143	VR-B396	24	0-124-655-007			VR-B396	24
0-124-555-005			VR-B268	20	0-124-655-008			VR-B268	20
0-124-555-006			VR-B268	20	0-124-655-009			VR-B122B	6
0-124-555-007	RB-117H	143	VR-B396	24	0-124-655-011			VR-B122B	6
0-124-555-008	RB-117H	143	VR-B396	24	0-124-655-012			VR-B268	20
0-124-555-009			VR-B268	20	0-124-655-013			VR-B268	20
0-124-555-010			VR-B268	20	0-124-655-016			VR-B396	24
0-124-555-011			VR-B396	24	0-124-655-019			VR-B268	20
0-124-555-012			VR-B396	24	0-124-655-023			VR-B396	24
0-124-555-013			VR-B122B	6	0-124-655-025			VR-B122B	6
0-124-555-014			VR-B122B	6	0-124-655-026			VR-B122B	6
0-124-555-015	RB-117H	143	VR-B396	24	0-124-655-030			VR-B268	20
0-124-555-016			VR-B396	24	0-124-655-033			VR-B268	20
0-124-555-017			VR-B268	20	0-124-655-036			VR-B118B	6
0-124-555-020			VR-B268	20	0-124-655-037			VR-B118B	6
0-124-555-021			VR-B396	24	0-124-655-038			VR-B396	24
0-124-555-022	RB-117H	143	VR-B396	24	0-124-655-039			VR-B118B	6
0-124-555-023			VR-B396	24	0-124-655-042			VR-B396	24
0-124-555-025			VR-B396	24	0-124-655-047			VR-B122B	6
0-124-555-028			VR-B268	20	0-124-655-082			VR-B268	20
0-124-555-030			VR-B268	20	0-125-711-005			VR-B057	5
0-124-555-032	RB-117H	143	VR-B396	24	0-125-711-011			VR-B135	7
0-124-555-034			VR-B122B	6	0-125-711-030	RB-195H	150	VR-B839	26
0-124-555-036			VR-B118B	6	0-125-711-055			VR-B839	26
0-124-555-038			VR-B118B	6	0-125-711-090			VR-B6164	25
0-124-555-040			VR-B118B	6	0-125-711-106			VR-B057	5
0-124-555-041			VR-B118B	6	0-125-711-124			VR-B807	25
0-124-555-042			VR-B396	24	0-125-711-125			VR-B807	25
0-124-555-044			VR-B396	24	0-125-711-127			VR-B807	25
0-124-555-045			VR-B396	24	0-125-711-129			VR-B807	25
0-124-555-046			VR-B396	24	0-125-711-134	RB-195H	150		
0-124-555-052			VR-B118B	6	0-125-711-149			VR-B807	25
0-124-555-065	RB-117H	143	VR-B396	24	0-125-711-151			VR-B807	25
0-124-555-077			VR-B268	20	0-125-711-153			VR-B807	25
0-124-555-084			VR-B268	20	0-125-811-028			VR-B855	26
0-124-615-002			VR-B263	19	0-125-811-033			VR-B855	26
0-124-615-007			VR-B296	21	0-125-811-035			VR-B855	26
0-124-615-008			VR-B247	17	0-125-811-054			VR-B835	26
0-124-615-009			VR-B296	21	0-125-811-073			VR-B855	26
0-124-615-012			VR-B247	17	0-125-811-088			VR-B855	26
0-124-615-013			VR-B247	17	0-125-811-089			VR-B855	26
0-124-615-015			VR-B264	19	0-125-811-115			VR-B855	26
0-124-615-019			VR-B264	19	0-125-812-009			VR-B839	26
0-124-615-020			VR-B247	17	0-125-813-002			VR-B112	6
0-124-615-021			VR-B296	21	0-125-813-009			VR-B112	6
0-124-615-025			VR-B414	24	0-125-813-015	RB-197H	150	VR-B0818	5
0-124-615-027			VR-B263	19	0-125-813-016	RB-197H	150	VR-B0818	5
0-124-615-028			VR-B385	23	0-126-312-006			VR-B3102	21
0-124-615-029	RB-184HV	149	VR-B129	7	0-126-312-014			VR-B3010	21
0-124-615-031			VR-B296	21	0-126-312-016			VR-B3010	21
0-124-615-033			VR-B264	19	0-127-469-624	RB-40H	152		
0-124-615-035			VR-B363	22	0131540002			VR-B132	7
0-124-615-038			VR-B296	21	0131541302			VR-B264	19
0-124-615-044			VR-B861	26	0131541502			VR-B264	19
0-124-615-046			VR-B414	24	0131541702			VR-B264	19
0-124-615-047			VR-B861	26	0131543202			VR-B363	22
0-124-625-001	RB-166H	147	VR-B369	22	0131543402			VR-B363	22
0-124-625-002			VR-B883	27	0131543502			VR-B021	4
0-124-625-003	RB-166H	147	VR-B369	22	0131543602			VR-B363	22
0-124-625-004			VR-B883	27	0131545602			VR-B021	4
0-124-625-005	RB-166H	147	VR-B247	17	0131547002			VR-B021	4
0-124-625-006	RB-166H	147	VR-B414	24	0131549002			VR-B021	4
0-124-625-007	RB-166H	147	VR-B247	17	0141543702			VR-B885	27
0-124-625-010	RB-166H	147	VR-B296	21	0-399-604-015			VR-B885	27
0-124-625-014			VR-B132	7	03L903023K			VR-B854	26
0-124-625-015			VR-B132	7	03L903024M			VR-B854	26
0-124-625-018			VR-B296	21	03L903024X			VR-B854	26

CROSS REFERENCE
Voltage Regulator

CROSS REFERENCE
Rectifier

CROSS REFERENCE
Diode Trio

ALTERNATOR NO.
Reg & Rec

CROSS REFERENCE LIST

OEM Alternator No. → Mobiletron No.

OEM Alternator No.	Rectifier No.	Page	Regulator No.	Page	OEM Alternator No.	Rectifier No.	Page	Regulator No.	Page
04B903023B			VR-B854	26	0-986-031-600	RB-78HA	155		
04B903023D			VR-B854	26	0-986-032-720	RB-72H	154		
04C903023L			VR-B854	26	0-986-032-730	RB-51H	153		
04E903023B	RB-187H	149			0-986-032-930	RB-04H	140		
04E903023J	RB-187H	149	VR-B854	26	0-986-032-990	RB-47H	152		
04E903023JX	RB-187H	149			0-986-033-010	RB-47H	152		
04E903025J			VR-B0701	5	0-986-033-077	RB-10H	142		
04L903023K			VR-B854	26	0-986-033-100	RB-72H	154		
059903018S			VR-B807	25	0-986-033-110	RB-43H	152		
059903019J			VR-B807	25	0-986-033-140	RB-43H	152		
059903019M			VR-B807	25	0-986-033-150	RB-54H	153		
059903019N			VR-B807	25	0-986-033-160	RB-51H	153		
06E903019D			VR-B807	25	0-986-033-250	RB-02H	140		
06E903019DX			VR-B807	25	0-986-033-320	RB-15H	147		
06J903023A			VR-B854	26	0-986-033-330	RB-02H	140		
06J903023G			VR-B854	26	0-986-033-340	RB-03HA	140		
06K903023			VR-B0701	5	0-986-033-350	RB-03HA	140		
06K903023X			VR-B0701	5	0-986-033-510	RB-08H	141		
0-983-032-950	RB-02H	140			0-986-033-520	RB-78HA	155		
0-986-030-110	RB-13H	146			0-986-033-530	RB-72H	154		
0-986-030-120	RB-10H	142			0-986-033-550	RB-78HA	155		
0-986-030-121	RB-10H	142			0-986-033-570	RB-08H	141		
0-986-030-130	RB-13H	146			0-986-033-710	RB-54H	153		
0-986-030-140	RB-13H	146			0-986-033-820	RB-07H	141		
0-986-030-480	RB-02H	140			0-986-033-840	RB-72H	154		
0-986-030-500	RB-02H	140			0-986-033-860	RB-06HA	141		
0-986-030-510	RB-43H	152			0-986-033-910	RB-02H	140		
0-986-030-520	RB-71H	154			0-986-033-940	RB-06HA	141		
0-986-030-650	RB-02H	140			0-986-034-010	RB-57H	153		
0-986-030-660	RB-08H	141			0-986-034-020	RB-54H	153		
0-986-030-670	RB-02H	140			0-986-034-030	RB-54H	153		
0-986-030-671	RB-02H	140			0-986-034-070	RB-72H	154		
0-986-030-680	RB-02H	140			0-986-034-080	RB-55H	153		
0-986-030-690	RB-02H	140			0-986-034-110	RB-55H	153		
0-986-030-700	RB-02H	140			0-986-034-120	RB-02H	140		
0-986-030-710	RB-02H	140			0-986-034-130	RB-51H	153		
0-986-030-730	RB-02H	140			0-986-034-140	RB-53H	153		
0-986-030-731	RB-02H	140			0-986-034-150	RB-51H	153		
0-986-030-760	RB-06HA	141			0-986-034-160	RB-51H	153		
0-986-030-761	RB-06HA	141			0-986-034-170	RB-55H	153		
0-986-030-790	RB-06HA	141			0-986-034-200	RB-06HA	141		
0-986-030-800	RB-02H	140			0-986-034-210	RB-08H	141		
0-986-030-810	RB-02H	140			0-986-034-220	RB-05H	141		
0-986-030-830	RB-02H	140			0-986-034-230	RB-05H	141		
0-986-030-840	RB-19H	150			0-986-034-231	RB-05H	141		
0-986-030-850	RB-02H	140			0-986-034-240	RB-04H	140		
0-986-030-870	RB-02H	140			0-986-034-250	RB-05H	141		
0-986-030-880	RB-19H	150			0-986-034-251	RB-05H	141		
0-986-030-900	RB-02H	140			0-986-034-350	RB-08H	141		
0-986-030-910	RB-02H	140			0-986-034-360	RB-72H	154		
0-986-030-920	RB-19H	150			0-986-034-370	RB-72H	154		
0-986-030-930	RB-19H	150			0-986-034-380	RB-47H	152		
0-986-030-940	RB-02H	140			0-986-034-420	RB-71H	154		
0-986-030-990	RB-02H	140			0-986-034-430	RB-72H	154		
0-986-031-050	RB-02H	140			0-986-034-450	RB-17H	148		
0-986-031-070	RB-02H	140			0-986-034-470	RB-38H	151		
0-986-031-090	RB-02H	140			0-986-034-490	RB-02H	140		
0-986-031-091	RB-02H	140			0-986-034-500	RB-04H	140		
0-986-031-120	RB-13H	146	VR-B220	15	0-986-034-501	RB-04H	140		
0-986-031-150	RB-02H	140			0-986-034-510	RB-05H	141		
0-986-031-190	RB-08H	141			0-986-034-511	RB-05H	141		
0-986-031-200	RB-02H	140			0-986-034-520	RB-05H	141		
0-986-031-210	RB-02H	140			0-986-034-530	RB-04H	140		
0-986-031-230	RB-08H	141			0-986-034-531	RB-04H	140		
0-986-031-240	RB-02H	140			0-986-034-550	RB-05H	141		
0-986-031-250	RB-08H	141			0-986-034-560	RB-04H	140		
0-986-031-251	RB-08H	141			0-986-034-570	RB-04H	140		
0-986-031-260	RB-08H	141			0-986-034-580	RB-05H	141		
0-986-031-270	RB-07H	141			0-986-034-600	RB-78HA	155		
0-986-031-280	RB-02H	140			0-986-034-610	RB-78HA	155		
0-986-031-290	RB-08H	141			0-986-034-640	RB-02H	140		
0-986-031-300	RB-07H	141			0-986-034-650	RB-19H	150		
0-986-031-310	RB-08H	141			0-986-034-651	RB-19H	150		
0-986-031-320	RB-07H	141			0-986-034-660	RB-19H	150		
0-986-031-330	RB-08H	141			0-986-034-690	RB-60H	154		
0-986-031-340	RB-02H	140			0-986-034-730	RB-02H	140		
0-986-031-360	RB-02H	140			0-986-034-910	RB-78HA	155		
0-986-031-361	RB-02H	140			0-986-034-930	RB-19H	150		
0-986-031-370	RB-07H	141			0-986-034-931	RB-02H	140		
0-986-031-450	RB-07H	141			0-986-034-990	RB-04H	140		
0-986-031-460	RB-02H	140			0-986-035-010	RB-05H	141		
0-986-031-470	RB-03HA	140			0-986-035-020	RB-52H	153		
0-986-031-480	RB-03HA	140			0-986-035-630	RB-02H	140		
0-986-031-481	RB-03HA	140			0-986-035-690	RB-02H	140		
0-986-031-501	RB-03HA	140			0-986-035-700	RB-51H	153		

CROSS REFERENCE
Voltage Regulator

CROSS REFERENCE
Rectifier

CROSS REFERENCE
Diode Trio

ALTERNATOR NO.
Reg & Rec

CROSS REFERENCE LIST

OEM Alternator No. → Mobiletron No.

OEM Alternator No.	Rectifier No.	Page	Regulator No.	Page	OEM Alternator No.	Rectifier No.	Page	Regulator No.	Page
0-986-035-710	RB-51H	153			11217			VR-B378	23
0-986-035-720	RB-51H	153			11220			VR-B021	4
0-986-035-730	RB-77H	155			11232			VR-B314	21
0-986-035-740	RB-49H	152			11234			VR-B314	21
0-986-035-750	RB-49H	152			11235	RB-180HV	149		
0-986-035-770	RB-52H	153			11236			VR-B314	21
0-986-035-810	RB-77H	155			11300			VR-B088	5
0-986-035-820	RB-54H	153			11301			VR-B033	4
0-986-035-910	RB-07H	141			11302			VR-B033	4
0-986-036-000	RB-53H	153			11303			VR-B021	4
0-986-036-010	RB-06HA	141			11304			VR-B020	4
0-986-036-020	RB-06HA	141			11305			VR-B020	4
0-986-036-050	RB-57H	153			11307			VR-B021	4
0-986-036-110	RB-06HA	141			11308			VR-B020	4
0-986-036-240	RB-72H	154			11310			VR-B020	4
0-986-036-260	RB-05H	141			11314	RB-180HV	149		
0-986-036-350	RB-54H	153			11335			VR-B066	5
0-986-036-360	RB-54H	153			11336			VR-B066	5
0-986-036-480	RB-02H	140			11345			VR-B057	5
0-986-036-510	RB-05H	141			11346			VR-B057	5
0-986-036-530	RB-19H	150			11348	RB-194H	150	VR-B330	22
0-986-036-540	RB-19H	150			11362			VR-B033	4
0-986-036-660	RB-54H	153			11363			VR-B379	23
0-986-036-690	RB-160H	147			11444			VR-B020	4
0-986-036-750	RB-02H	140			11445			VR-B020	4
0-986-036-760	RB-49H	152			11447			VR-B379	23
0-986-036-770	RB-48H	152			11488			VR-B379	23
0-986-036-780	RB-51H	153			11723			VR-B0701	5
0-986-036-920	RB-71H	154			11725			VR-B6164	25
0-986-037-010	RB-57H	153			0-120-489-022			VR-B202L	14
0-986-037-040	RB-54H	153			12148			VR-B260B	18
0-986-037-760	RB-66H	154			12219			VR-B260B	18
0-986-038-050	RB-04H	140			123 8 614 277	RB-197H	150		
0-986-038-080	RB-04H	140			12317501595	RB-168H	147		
0-986-038-090	RB-07H	141			12317501597	RB-168H	147		
0-986-038-220	RB-54H	153			12317501599	RB-168H	147		
0-986-038-300	RB-54H	153			12317501690	RB-168H	147		
0-986-038-310	RB-49H	152			12-31-7-507-741			VR-B5204	24
0-986-038-330	RB-49H	152			12-31-7-507-995			VR-B5204	24
0-986-038-340	RB-54H	153			12-31-7-519-721			VR-B278	20
0-986-038-660	RB-160H	147			12-31-7-519-723			VR-B278	20
0-986-038-750	RB-49H	152			12-31-7-521-135			VR-B278	20
0-986-038-950	RB-178H	148			12317521384			VR-B880	27
0-986-039-030	RB-178H	148			12317521490			VR-B880	27
0-986-040-380	RB-101H	141			12317521491			VR-B880	27
0-986-040-940	RB-178H	148			12317532965	RB-174HD	148	VR-B880	27
0-986-041-760			VR-B257	18	12317532966	RB-174HD	148	VR-B880	27
0-986-047-380			VR-B379	23	12317532969	RB-174HD	148	VR-B880	27
0-986-047-500			VR-B379	23	12317533270	RB-174HD	148	VR-B880	27
0-986-047-510			VR-B379	23	12317542351			VR-B033	4
10335497			VR-B314	21	12-31-7-546-284			VR-B278	20
10366269			VR-B314	21	12-31-7-546-285			VR-B278	20
10418888			VR-B259	18	12317550469			VR-B033	4
11042			VR-B296	21	12317550967			VR-B088	5
11064			VR-B296	21	12317551254			VR-B033	4
11065			VR-B296	21	12317551256			VR-B033	4
11068			VR-B861	26	12317555926			VR-B033	4
11074			VR-B394	23	12317557789			VR-B033	4
11075			VR-B314	21	12317558219			VR-B033	4
11076	RB-167HV	147			12317558220			VR-B033	4
11081			VR-B369	22	12317560985			VR-B033	4
11082			VR-B369	22	12317560986			VR-B033	4
11083			VR-B278	20	12317582699			VR-B033	4
11091			VR-B379	23	12317604782			VR-B135	7
11124			VR-B861	26	12317613445			VR-B135	7
11125			VR-B314	21	12318614277			VR-B0818	5
11126			VR-B314	21	12382			VR-B264	19
11127			VR-B314	21	12383			VR-B264	19
11129			VR-B243	16	12384			VR-B264	19
11133			VR-B296	21	12387			VR-B396	24
11134			VR-B296	21	12389			VR-B396	24
11185			VR-B314	21	12587			VR-B260B	18
11201068			VR-B193M	10	12780	RB-188H	149		
11201071			VR-B193M	10	13382	RB-178H	148		
11201077			VR-B193M	10	13777	RB-171HV	148		
11201078			VR-B193M	10	13801			VR-B221	15
11201117			VR-B193M	10	13802			VR-B221	15
11201143			VR-B193M	10	13815			VR-B394	23
11201146			VR-B193M	10	13843	RB-180HV	149		
11201147			VR-B193M	10	13849			VR-B296	21
11201167			VR-B193M	10	13850			VR-B296	21
11201220			VR-B193M	10	13851			VR-B296	21
11201222			VR-B193M	10	13852			VR-B296	21
11215	RB-181HD	149	VR-B885	27	13853			VR-B296	21
11216			VR-B132	7	13872	RB-171HV	148		

CROSS REFERENCE
Voltage Regulator

CROSS REFERENCE
Rectifier

CROSS REFERENCE
Diode Trio

ALTERNATOR NO.
Reg & Rec

CROSS REFERENCE LIST

OEM Alternator No. → Mobiletron No.

OEM Alternator No.	Rectifier No.	Page	Regulator No.	Page	OEM Alternator No.	Rectifier No.	Page	Regulator No.	Page
13884			VR-B296	21	42540208			VR-B268	20
13904			VR-B296	21	42560643			VR-B268	20
13916	RB-171HV	148			4801475AA	RB-180HV	149		
13917	RB-171HV	148			51256010006			VR-B122B	6
13920	RB-180HV	149			5134199AA			VR-B264	19
13953			VR-B861	26	5134204AA			VR-B264	19
13976			VR-B5204	24	5134205AA			VR-B264	19
13985	RB-171HV	148			51905540			VR-B703	25
13986	RB-929HV	156			56028239AB	RB-180HV	149		
13987	RB-180HV	149			56028732AA	RB-180HV	149		
13997			VR-B221	15	56041120AC	RB-171HV	148		
13998			VR-B369	22	56041322	RB-171HV	148		
14051	RB-181HD	149			56041322AB	RB-171HV	148		
1450808			VR-B268	20	6004MA5008			VR-B259	18
1501245			VR-B396	24	6-004-ML0-000	RB-171HV	148		
1502245			VR-B396	24	6-004-ML0-001	RB-171HV	148		
15124532	RB-179HV	148			6-004-ML0-005	RB-171HV	148		
15200267	RB-167HV	147			6004ML0017			VR-B259	18
15222342	RB-167HV	147			6-004-ML0-017	RB-929HV	156		
15233597			VR-B314	21	6-004-ML0-021	RB-929H	156		
1561540102			VR-B021	4	6004ML0024			VR-B259	18
1624197			VR-B268	20	6033GB3047			VR-B226	16
1794477			VR-B268	20	6361540102			VR-B885	27
1797688			VR-B122B	6	68011841AA			VR-B378	23
1806492			VR-B268	20	68011841AB			VR-B378	23
1C35-10300AA	RB-161H	147			6C1T-10300AA			VR-B026	4
1C35-10300AB	RB-161H	147			6C1T-10300AB			VR-B026	4
20005			VR-B322	22	6C1T-10300AC			VR-B026	4
20011			VR-B029	4	7420523391			VR-B268	20
20035	RB-195H	150			8000429905			VR-B131	7
20036			VR-B021	4	82 0323137			VR-B131	7
20446			VR-B033	4	8200323137			VR-B131	7
20523391			VR-B268	20	8200325823			VR-B131	7
20741	RB-195H	150			8200356669			VR-B131	7
21019217			VR-B265	19	8200360480			VR-B131	7
21174	RB-160H	147			8200429905			VR-B131	7
21177	RB-160H	147			8200518409			VR-B131	7
21222	RB-160H	147			8200660025			VR-B131	7
21364	RB-160H	147			8200660033			VR-B131	7
22674550			VR-B265	19	8200660034			VR-B131	7
22820			VR-B296	21	8200660043			VR-B131	7
22821			VR-B296	21	8200726639			VR-B131	7
22973			VR-B861	26	8602713			VR-B369	22
23095			VR-B861	26	8602714			VR-B369	22
23097			VR-B861	26	8603263			VR-B379	23
23100-4EA0A			VR-B827	25	8603264			VR-B379	23
23115			VR-B296	21	8637849			VR-B369	22
23143			VR-B861	26	8651665			VR-B369	22
23251	RB-188H	149			8676499			VR-B369	22
23254			VR-B880	27	87715948			VR-B268	20
23261			VR-B131	7	87HLL-10300DA	RB-159H	146		
23285			VR-B385	23	89JA-10300AA			VR-B391	23
23289			VR-B296	21	9-120-060-009	RB-84H	156	VR-B391	23
23321			VR-B296	21	9-120-060-020	RB-82H	156	VR-B391	23
23322			VR-B296	21	9-120-060-023	RB-84H	156	VR-B392	23
23356			VR-B296	21	9-120-060-027	RB-81H	156		
23358			VR-B296	21	9-120-060-039			VR-B260B	18
23369			VR-B295	21	9-120-060-910			VR-B194	10
23561			VR-B135	7	9-120-061-100			VR-B393	23
23775	RB-174HD	148	VR-B880	27	9-120-067-027	RB-83H	156		
23777			VR-B131	7	9-120-080-020	RB-124H	144		
23818			VR-B131	7	9-120-080-031	RB-124H	144		
23819			VR-B131	7	9-120-080-039			VR-B100	6
23872			VR-B295	21	9-120-080-041	RB-137HV	145		
24015			VR-B131	7	9-120-080-045	RB-130H	145		
24044			VR-B131	7	9-120-080-049	RB-130H	145	VR-B100	6
27060-02100			VR-B510	24	9-120-080-054	RB-124H	144		
27060-0J061			VR-B243	16	9-120-080-055			VR-B100	6
27060-0P010			VR-B243	16	9-120-080-057	RB-130H	145		
27060-0Q040	RB-190H	150			9-120-080-058			VR-B100	6
27060-0N011	RB-190H	150			9-120-080-061	RB-137H	145		
2721540002			VR-B885	27	9-120-080-061	RB-137HV	145		
272-154-01-02			VR-B378	23	9-120-080-061			VR-B211	15
2721540802			VR-B021	4	9-120-080-064			VR-B100	6
2TB903803A			VR-B396	24	9-120-080-067			VR-B100	6
30658084			VR-B379	23	9-120-080-069			VR-B100	6
30658086			VR-B379	23	9-120-080-072	RB-137H	145		
30659580			VR-B839	26	9-120-080-072	RB-137HV	145		
30667892			VR-B379	23	9-120-080-072			VR-B211	15
30667893			VR-B379	23	9-120-080-073			VR-B100	6
36002812			VR-B839	26	9-120-080-075			VR-B100	6
37300-21013			VR-B190	8	9-120-080-082	RB-124H	144		
37300-21320			VR-B191	9	9-120-080-084	RB-124H	144		
37900-21030			VR-B190	8	9-120-080-085	RB-130H	145	VR-B100	6
42537055			VR-B268	20	9-120-080-090	RB-137HV	145	VR-B211	15

CROSS REFERENCE LIST

OEM Alternator No. → Mobiletron No.

OEM Alternator No.	Rectifier No.	Page	Regulator No.	Page	OEM Alternator No.	Rectifier No.	Page	Regulator No.	Page
9-120-080-091	RB-124H	144			9-120-144-073	RB-02H	140		
9-120-080-094	RB-130H	145	VR-B100	6	9-120-144-086	RB-02H	140		
9-120-080-103			VR-B100	6	9-120-144-087	RB-02H	140		
9-120-080-104			VR-B100	6	9-120-144-101	RB-02H	140	VR-B197	12
9-120-080-105			VR-B100	6	9-120-144-102			VR-B197	12
9-120-080-106			VR-B100	6	9-120-144-103			VR-B197	12
9-120-080-107	RB-130H	145			9-120-144-104			VR-B197	12
9-120-080-110	RB-124H	144			9-120-144-105	RB-02H	140	VR-B197	12
9-120-080-112	RB-08H	141			9-120-144-106			VR-B197	12
9-120-080-113	RB-08H	141	VR-B100	6	9-120-144-107			VR-B197	12
9-120-080-114	RB-07H	141			9-120-144-109	RB-02H	140	VR-B197	12
9-120-080-122			VR-B211	15	9-120-144-110			VR-B197	12
9-120-080-125	RB-124H	144			9-120-144-112	RB-07H	141		
9-120-080-126	RB-08H	141			9-120-144-113	RB-08H	141		
9-120-080-129	RB-05H	141			9-120-144-115	RB-07H	141		
9-120-080-130	RB-07H	141			9-120-144-116	RB-08H	141	VR-B210	15
9-120-080-132	RB-08H	141			9-120-144-117	RB-07H	141	VR-B210	15
9-120-080-134	RB-08H	141			9-120-144-119	RB-15H	147	VR-B203	14
9-120-080-136	RB-07H	141			9-120-144-120	RB-07H	141	VR-B210	15
9-120-080-137	RB-07H	141			9-120-144-121	RB-02H	140	VR-B198	12
9-120-080-138	RB-130H	145			9-120-144-122	RB-02H	140	VR-B210	15
9-120-080-140	RB-08H	141			9-120-144-123	RB-08H	141	VR-B210	15
9-120-080-144	RB-07H	141	VR-B260B	18	9-120-144-124	RB-02H	140		
9-120-080-145	RB-08H	141			9-120-144-125	RB-08H	141	VR-B198	12
9-120-080-146	RB-130H	145	VR-B100	6	9-120-144-127	RB-08H	141	VR-B210	15
9-120-080-149	RB-08H	141			9-120-144-129			VR-B203	14
9-120-080-150	RB-07H	141	VR-B100	6	9-120-144-130	RB-08H	141	VR-B198	12
9-120-080-151	RB-08H	141			9-120-144-131	RB-08H	141	VR-B210	15
9-120-080-153			VR-B103	6	9-120-144-132	RB-08H	141	VR-B210	15
9-120-080-154	RB-08H	141			9-120-144-133	RB-08H	141	VR-B198	12
9-120-080-157	RB-07H	141			9-120-144-137	RB-07H	141		
9-120-080-158	RB-08H	141			9-120-144-205	RB-02H	140		
9-120-080-160	RB-07H	141			9-120-144-207	RB-02H	140		
9-120-080-161			VR-B104	6	9-120-144-216	RB-02H	140		
9-120-080-162	RB-07H	141			9-120-144-217	RB-02H	140		
9-120-080-163			VR-B104	6	9-120-144-219			VR-B204	14
9-120-080-164			VR-B104	6	9-120-144-220			VR-B204	14
9-120-080-165			VR-B103	6	9-120-144-223	RB-01HA	140		
9-120-080-166	RB-07H	141			9-120-144-224	RB-01HA	140		
9-120-080-167	RB-148H	146	VR-B104	6	9-120-144-227	RB-01HA	140		
9-120-080-168			VR-B103	6	9-120-144-231			VR-B205	14
9-120-080-169			VR-B103	6	9-120-144-232			VR-B204	14
9-120-080-170			VR-B103	6	9-120-144-233			VR-B204	14
9-120-080-171			VR-B103	6	9-120-144-234	RB-02H	140		
9-120-080-172			VR-B103	6	9-120-144-236	RB-02H	140		
9-120-080-173			VR-B103	6	9-120-144-237	RB-02H	140		
9-120-080-175			VR-B104	6	9-120-144-255	RB-02H	140		
9-120-080-176			VR-B104	6	9-120-144-257			VR-B207	14
9-120-080-177			VR-B104	6	9-120-144-258			VR-B207	14
9-120-080-178			VR-B104	6	9-120-144-260			VR-B207	14
9-120-080-179			VR-B104	6	9-120-144-262			VR-B207	14
9-120-080-180			VR-B103	6	9-120-144-264			VR-B207	14
9-120-080-185			VR-B104	6	9-120-144-266	RB-02H	140		
9-120-080-186			VR-B104	6	9-120-144-267			VR-B207	14
9-120-080-190			VR-B104	6	9-120-144-268			VR-B207	14
9-120-080-191			VR-B104	6	9-120-144-272			VR-B207	14
9-120-080-192			VR-B104	6	9-120-144-274			VR-B207	14
9-120-080-193			VR-B104	6	9-120-144-276			VR-B207	14
9-120-080-194			VR-B104	6	9-120-144-278			VR-B207	14
9-120-080-197	RB-138H	145			9-120-144-280	RB-01HA	140		
9-120-080-198			VR-B103	6	9-120-144-281	RB-06HA	141		
9-120-080-203			VR-B103	6	9-120-144-282	RB-06HA	141		
9-120-080-208			VR-B103	6	9-120-144-284			VR-B207	14
9-120-080-211			VR-B103	6	9-120-144-286			VR-B207	14
9-120-080-212	RB-158H	146			9-120-144-288	RB-01HA	140		
9-120-080-213			VR-B103	6	9-120-144-292	RB-17H	148		
9-120-080-215	RB-145H	146			9-120-144-298			VR-B207	14
9-120-080-222	RB-145H	146			9-120-144-301	RB-06HA	141		
9-120-080-226	RB-146H	146			9-120-144-303			VR-B207	14
9-120-080-230	RB-158H	146			9-120-144-305	RB-17H	148		
9-120-080-231	RB-145H	146			9-120-144-605	RB-17H	148		
9-120-080-232	RB-146H	146			9-120-144-606	RB-17H	148		
9-120-143-003	RB-13H	146			9-120-144-608	RB-17H	148		
9-120-143-017	RB-10H	142			9-120-144-609	RB-17H	148		
9-120-143-021	RB-13H	146			9-120-144-610	RB-17H	148		
9-120-143-025	RB-13H	146			9-120-144-611	RB-17H	148		
9-120-143-026	RB-13H	146			9-120-144-612	RB-17H	148		
9-120-143-201	RB-13H	146			9-120-144-613	RB-17H	148		
9-120-143-202	RB-13H	146			9-120-144-614	RB-17H	148		
9-120-143-204	RB-10H	142			9-120-144-617	RB-17H	148		
9-120-143-216			VR-B192	9	9-120-144-618	RB-17H	148		
9-120-143-218	RB-10H	142			9-120-144-621	RB-17H	148		
9-120-143-222	RB-13H	146			9-120-144-622	RB-17H	148		
9-120-143-223	RB-13H	146			9-120-144-626	RB-17H	148		
9-120-143-228	RB-13H	146			9-120-144-635	RB-17H	148		

**CROSS REFERENCE
Voltage Regulator**

**CROSS REFERENCE
Rectifier**

**CROSS REFERENCE
Diode Trio**

**ALTERNATOR NO.
Reg & Rec**

CROSS REFERENCE LIST

OEM Alternator No. → Mobiletron No.

	OEM Alternator No.	Rectifier No.	Page	Regulator No.	Page	OEM Alternator No.	Rectifier No.	Page	Regulator No.	Page
CROSS REFERENCE Voltage Regulator	9-120-180-020J	RB-85H	156			AAK1185			VR-B193M	10
	9-120-334-137	RB-07H	141			AB; 56028238AB	RB-180HV	149		
	9-120-334-626	RB-17H	148			AR160A			VR-B190	8
	9-120-334-628	RB-17H	148			BG9T-10300AB			VR-B057	5
	9-120-334-635	RB-17H	148			E5HT-10300EA	RB-159H	146		
	9-120-344-628	RB-17H	148			E8GY-10346A			VR-B191	9
	9-120-450-006	RB-159H	146	VR-B218	15	E8GY-10346-A			VR-B190	8
	9-120-450-042	RB-128H	145			E8GY-10346B			VR-B191	9
	9-120-450-044	RB-128H	145	VR-B212	15	E8GY-10346-B			VR-B190	8
	9-120-450-052	RB-128H	145			E9BZ-10346A			VR-B191	9
9-120-450-053	RB-128H	145			E9BZ-10346-A			VR-B190	8	
9-120-450-058	RB-128H	145			E9JY-10346A			VR-B391	23	
9-120-450-071	RB-128H	145	VR-B212	15	E9YJ-10346A	RB-82H	156			
9-120-450-077			VR-B212	15	F-000-BL0-424	RB-185HV	149		VR-B0701	5
9-120-450-085	RB-128H	145	VR-B212	15	F-000-BL0-601				VR-B704	25
9-120-450-090	RB-128H	145	VR-B212	15	F-000-BL0-605				VR-B704	25
9-120-450-092	RB-128H	145	VR-B212	15	F-000-BL0-612				VR-B704	25
9-120-450-093	RB-128H	145			F-000-BL0-618	RB-185HV	149		VR-B0701	5
9-120-450-100	RB-128H	145	VR-B212	15	F-000-BL0-626				VR-B704	25
9-120-450-102	RB-128H	145	VR-B212	15	F-000-BL0-633				VR-B704	25
9-120-450-105			VR-B212	15	F-000-BL0-638				VR-B704	25
9-120-450-107			VR-B212	15	F-000-BL0-639				VR-B056	5
9-120-450-113	RB-128H	145	VR-B212	15	F-000-BL0-659				VR-B704	25
9-120-450-118			VR-B212	15	F-000-BL0-6AK				VR-B056	5
9-120-450-119			VR-B212	15	F-000-BL0-6B7				VR-B056	5
9-120-450-124	RB-159H	146			F-000-BL0-6Z0				VR-B056	5
9-120-450-130	RB-128H	145			F-000-BL0-730				VR-B0701	5
9-120-450-131			VR-B212	15	F-000-BL0-740	RB-189H	149		VR-B703	25
9-120-450-132	RB-128H	145			F-000-BL0-743	RB-189H	149			
9-120-450-134			VR-B218	15	F-000-BL0-797				VR-B842	26
9-120-450-137			VR-B218	15	F-000-BL0-7Z9				VR-B903	27
9-120-450-998			VR-B102	6	F-000-BL0-802				VR-B854	26
9-120-456-003			VR-B219	15	F-000-BL0-803				VR-B854	26
9-120-456-014			VR-B219	15	F-000-BL0-805	RB-187H	149		VR-B854	26
9-120-456-016			VR-B219	15	F-000-BL0-809				VR-B0701	5
9-120-456-024			VR-B218	15	F-000-BL0-818	RB-187H	149		VR-B854	26
9-120-456-028			VR-B219	15	F-000-BL0-825				VR-B827	25
9-120-690-006	RB-01HA	140			F-000-BL0-829				VR-B854	26
9-120-690-007	RB-01HA	140			F-000-BL0-830	RB-187H	149		VR-B854	26
9-120-690-011	RB-01HA	140			F-000-BL0-836				VR-B0701	5
9-120-690-012	RB-01HA	140			F-000-BL0-861				VR-B0701	5
9-120-690-013	RB-01HA	140			F-000-BL0-890				VR-B827	25
9-120-690-014	RB-01HA	140			F-000-BL0-8A0				VR-B854	26
9-120-690-015	RB-01HA	140			F-000-BL0-8A1				VR-B854	26
9-120-690-020	RB-02H	140			F-000-BL0-8C8	RB-187H	149		VR-B854	26
9-120-690-021	RB-02H	140			F-000-BL0-8E0				VR-B827	25
9-120-690-025	RB-02H	140			F-000-BL0-8E1				VR-B854	26
9-120-690-111	RB-02H	140			F-000-BL0-8E2				VR-B854	26
9-120-690-115	RB-02H	140			F-000-BL0-8F1				VR-B854	26
9-120-690-117	RB-02H	140			F-000-BL0-8F2				VR-B854	26
9-120-690-119	RB-02H	140			F-000-BL0-8F7				VR-B854	26
9-190-450-042	RB-125H	144			F-000-BL0-8F8				VR-B854	26
9-190-450-044	RB-125H	144			F-000-BL0-8G3				VR-B854	26
9-190-450-052	RB-125H	144			F-000-BL0-8G7				VR-B854	26
9-190-450-071	RB-125H	144			F-000-BL0-8P1				VR-B854	26
9-190-450-100	RB-125H	144			F-000-BL9-194				VR-B827	25
9-190-450-101	RB-125H	144			F-000-LD0-100	RB-146H	146			
9-190-450-102	RB-125H	144			F-000-LD0-102	RB-146H	146			
9-190-450-113	RB-125H	144			F-00M-145-313				VR-B129	7
9-190-450-118	RB-125H	144			F-00M-145-386				VR-B129	7
9-190-450-119	RB-125H	144			GX73-10300-DE	RB-196H	150			
9227893			VR-B265	19	JFZ21952	RB-163H	147			
9442841			VR-B221	15	JFZ2987	RB-158H	146			
A0009060022			VR-B839	26	CHRYSLER					
A0009061903			VR-B839	26	2095000				VR-C524	28
A0131547002			VR-B021	4	2095060				VR-C524	28
A0131549002			VR-B021	4	2095100				VR-C524	28
A0141543702			VR-B885	27	2095300				VR-C524	28
A131547002			VR-B021	4	2095425				VR-C524	28
A2711540802	RB-163H	147	VR-B385	23	2095661				VR-C524	28
A2721540002			VR-B885	27	3237797				VR-C545	28
A272-154-01-02			VR-B378	23	3438171				VR-C524	28
A6361540102			VR-B885	27	3438846				VR-C545	28
A6461540002			VR-B150	7	3438847				VR-C545H	28
AAK1114			VR-B193M	10	3656570				VR-C545	28
AAK1117			VR-B193M	10	3755585				VR-C545H	28
AAK1118			VR-B193M	10	4091727				VR-C545	28
AAK1119			VR-B193M	10	DAEWOO					
AAK1137			VR-B193M	10	19020601	RD-32	159			
AAK1148			VR-B193M	10	19020609	RD-32	159			
AAK1151			VR-B193M	10	19020611	RD-32	159			
AAK1152			VR-B193M	10	19020612	RD-32	159			
AAK1163			VR-B193M	10	219170	RD-32	159		VR-D271	29
AAK1182			VR-B193M	10	266000	RD-32	159			
AAK1183			VR-B193M	10	31400-A78-130				VR-K04	29

CROSS REFERENCE LIST

OEM Alternator No. → Mobiletron No.

OEM Alternator No.	Rectifier No.	Page	Regulator No.	Page	OEM Alternator No.	Rectifier No.	Page	Regulator No.	Page
31400-A78B02			VR-K04	29	10464492	RD-26HD	162	VR-D231	30
31410-A80D00			VR-K03	29	10464493	RD-26HD	162		
390104			VR-K06B	29	10470119			VR-D702H	36
8460	RD-32	159			10479214	RD-97D	164		
8461	RD-32	159			10479805			VR-D694HD	36
96303556			VR-D276	29	10479821	RD-08	159		
96380673	RD-32	159	VR-D271	29	10479850			VR-D668C	33
A124041			VR-K06B	29	10479852	RD-08	159	VR-D683H	35
A134153			VR-K06B	29	10479891	RD-08	159		
JFZ153			VR-K03	29	10479914	RD-04B	159	VR-D701	36
DELCO					10479923	RD-04B	159	VR-D701	36
0001500850			VR-D744	38	10479925			VR-D668C	33
0001501650			VR-D744	38	10479930			VR-D677	34
0001501750			VR-D745	38	10479947	RD-04B	159	VR-D701	36
0001502450			VR-D745	38	10479955	RD-04B	159	VR-D701	36
0001502550			VR-D745	38	10479959			VR-D683H	35
1005425	RD-13HV	160			10479966	RD-08	159		
1005428	RD-13HV	160			10479976			VR-D683H	35
1005493	RD-13HV	160			10479981	RD-97A	164	VR-D702H	36
102934			VR-D696B	36	10479984	RD-97A	164	VR-D702H	36
10310982	RD-26HD	162			10479995	RD-08	159	VR-D681H	34
10311493	RD-26HD	162			10480008			VR-D681H	34
10333165	RD-33	163			10480010	RD-07	159		
10333166	RD-33	163			10480017	RD-97A	164	VR-D702H	36
10346705	RD-33HD	163			10480018			VR-D678H	34
10392759	RD-40HA	163	VR-D755	38	10480019			VR-D678H	34
104080200	RD-08	159			10480043	RD-97A	164	VR-D703H	36
10442782	RD-33	163			10480052	RD-97A	164	VR-D702H	36
10442783	RD-33	163			10480055			VR-D445	32
10456313			VR-D668C	33	10480071	RD-97A	164	VR-D702H	36
10459003	RD-27H	162			10480072	RD-97A	164	VR-D702H	36
10459006	RD-27H	162			10480074			VR-D705H	36
10459017			VR-D680	34	10480076			VR-D705H	36
10459036			VR-D669C	33	10480079			VR-D705H	36
10463096			VR-D681H	34	1048008	RD-08	159		
10463108			VR-D681H	34	10480095			VR-D694HD	36
10463119			VR-D681H	34	10480096			VR-D694H	35
10463121			VR-D681H	34	10480111	RD-08	159		
10463122			VR-D681H	34	10480116			VR-D681H	34
10463189			VR-D681H	34	10480119	RD-97A	164	VR-D702H	36
10463190			VR-D681H	34	10480120			VR-D678H	34
10463201			VR-D681H	34	10480135			VR-D602H	32
10463295			VR-D681H	34	10480139	RD-08	159		
10463442			VR-D681H	34	10480171			VR-D602H	32
10463443	RD-97HV	164			10480190	RD-97D	164		
10463663			VR-D702H	36	10480227			VR-D445	32
10464395	RD-26HD	162			10480228			VR-D712	37
10464405	RD-26HD	162			10480229	RD-26	162	VR-D747HD	38
10464406	RD-26HD	162	VR-D232	30	10480231	RD-26HD	162		
10464408	RD-26HD	162	VR-D231	30	10480234	RD-26	162		
10464413			VR-D707	37	10480241	RD-26	162		
10464415			VR-D709	37	10480244	RD-26HD	162		
10464421			VR-D231	30	10480265			VR-D445	32
10464423			VR-D709	37	10480270	RD-26HD	162		
10464424			VR-D707	37	10480278			VR-D445	32
10464427			VR-D707	37	10480280			VR-D719	38
10464430	RD-26HD	162	VR-D231	30	10480285	RD-26HD	162		
10464431			VR-D709	37	10480288			VR-D707	37
10464432			VR-D709	37	10480296			VR-D445	32
10464437			VR-D707	37	10480297			VR-D445	32
10464439			VR-D231	30	10480298	RD-26HD	162		
10464440	RD-26HD	162			10480303	RD-26	162		
10464441	RD-26HD	162			10480311			VR-D445	32
10464442	RD-26HD	162			10480318			VR-D707	37
10464443	RD-26HD	162			10480320			VR-D709	37
10464452	RD-26HD	162			10480326	RD-26	162		
10464453	RD-26HD	162			10480327	RD-26HD	162	VR-D232	30
10464456	RD-26HD	162			10480331			VR-D707	37
10464459			VR-D233	30	10480336			VR-D707	37
10464460	RD-26HD	162	VR-D233	30	10480340			VR-D719	38
10464461	RD-26HD	162			10480341	RD-26	162	VR-D232	30
10464462			VR-D707	37	10480346			VR-D709	37
10464466	RD-26HD	162			10480350	RD-26HD	162		
10464467	RD-26HD	162			10480357	RD-26HD	162		
10464468	RD-26HD	162			10480361			VR-D709	37
10464469	RD-26HD	162			10480362			VR-D709	37
10464476	RD-26HD	162	VR-D235	30	10480368	RD-26HD	162	VR-D234	30
10464480	RD-26HD	162			10480378			VR-D707	37
10464482	RD-26HD	162			10480383	RD-26HD	162		
10464483			VR-D233	30	10480388	RD-26	162		
10464484			VR-D233	30	10480390	RD-26HD	162		
10464485	RD-26HD	162			10480403			VR-D744	38
10464487	RD-26HD	162			10480404			VR-D745	38
10464488	RD-26HD	162			10480407			VR-D745	38
10464489	RD-26HD	162			10480408			VR-D745	38

CROSS REFERENCE
Voltage Regulator

CROSS REFERENCE
Rectifier

CROSS REFERENCE
Diode Trio

ALTERNATOR NO.
Reg & Rec

CROSS REFERENCE LIST

OEM Alternator No. → Mobiletron No.

OEM Alternator No.	Rectifier No.	Page	Regulator No.	Page	OEM Alternator No.	Rectifier No.	Page	Regulator No.	Page
10480411			VR-D231	30	1100847			VR-D635	32
10480414	RD-26HD	162			1100849			VR-D635	32
10480428	RD-26	162	VR-D234	30	1100856			VR-D635	32
10480480	RD-26HD	162			1100860			VR-D635	32
10480497			VR-D712	37	1100870			VR-D635	32
10494492	RD-26HD	162			1100871			VR-D635	32
10497082			VR-D677	34	1100875			VR-D635	32
10497083			VR-D668C	33	1100878			VR-D635	32
10SITYPE116			VR-D672C	33	1100879			VR-D635	32
11000211			VR-D696B	36	1100886			VR-D635	32
1100077	RD-17	161	VR-D687	35	1100888			VR-D635	32
1100078	RD-17	161	VR-D696B	36	1100889			VR-D635	32
1100080	RD-17	161			1101015	RD-17	161		
1100095	RD-17H	161			1101016	RD-17H	161		
1100109			VR-D668C	33	1101018	RD-17	161		
1100110			VR-D668C	33	1101020	RD-17H	161		
1100111			VR-D668C	33	1101077	RD-14	160		
1100113			VR-D668C	33	1101091	RD-17H	161		
1100115			VR-D668C	33	1101096	RD-14	160		
1100116			VR-D668C	33	1101133			VR-D678H	34
1100117			VR-D668C	33	1101134			VR-D677	34
1100119			VR-D668C	33	1101199			VR-D424	31
1100120			VR-D668C	33	1101215			VR-D677	34
1100121			VR-D668C	33	1101224			VR-D677	34
1100124			VR-D668C	33	1101227	RD-95A	164		
1100125			VR-D668C	33	1101236			VR-D677	34
1100127			VR-D668C	33	1101252			VR-D677	34
1100128			VR-D668C	33	1101258			VR-D677	34
1100129			VR-D668C	33	1101266	RD-96	164		
1100130			VR-D668C	33	1101267	RD-95A	164		
1100131			VR-D668C	33	1101270			VR-D678H	34
1100132			VR-D668C	33	1101271	RD-96	164		
1100133			VR-D668C	33	1101280			VR-D677	34
1100134			VR-D668C	33	1101285	RD-12	160	VR-D687	35
1100135			VR-D668C	33	1101290			VR-D677	34
1100177	RD-17	161			1101295			VR-D678H	34
1100184	RD-31	162			1101296			VR-D681H	34
1100190	RD-14	160			1101308			VR-D677	34
1100192	RD-31	162			1101324			VR-D677	34
1100200	RD-12	160			1101328			VR-D677	34
1100207	RD-12	160			1101330			VR-D678H	34
1100208	RD-12	160			1101438	RD-14	160		
1100211			VR-D687	35	1101439	RD-12	160		
1100240	RD-12	160			1101440	RD-12	160		
1100241	RD-12	160			1101446	RD-14	160		
1100242	RD-12	160			1101450	RD-17H	161		
1100258	RD-12	160			1101465	RD-95A	164		
1100499	RD-09H	160			1101467	RD-96	164		
1100553			VR-D635	32	1101468	RD-96	164		
1100557			VR-D635	32	1101478	RD-95A	164		
1100558			VR-D635	32	1101480	RD-96	164		
1100566			VR-D635	32	1101482			VR-D683H	35
1100567			VR-D635	32	1101490			VR-D681H	34
1100568			VR-D635	32	1101518			VR-D681H	34
1100569			VR-D635	32	1101519			VR-D681H	34
1100570			VR-D635	32	1101550	RD-17	161		
1100571			VR-D635	32	1101551			VR-D424	31
1100572			VR-D635	32	1101561			VR-D683H	35
1100590			VR-D635	32	1101565	RD-95A	164		
1100591			VR-D635	32	1101571			VR-D683H	35
1100600			VR-D635	32	1101574			VR-D678H	34
1100601			VR-D635	32	1101578			VR-D681H	34
1100605			VR-D635	32	1101580	RD-08	159		
1100613			VR-D635	32	1101583	RD-96	164		
1100615			VR-D635	32	1101584			VR-D694H	35
1100616			VR-D635	32	1101591			VR-D678H	34
1100619			VR-D635	32	1101599	RD-95A	164		
1100654			VR-D635	32	1101605	RD-95A	164	VR-D683H	35
1100688			VR-D635	32	1101608	RD-95A	164		
1100693			VR-D635	32	1101612	RD-95A	164		
1100694			VR-D635	32	1101616			VR-D683H	35
1100699			VR-D635	32	1101625			VR-D683H	35
1100721			VR-D635	32	1101626			VR-D694H	35
1100722			VR-D635	32	1101806			VR-D683H	35
1100821			VR-D635	32	1101816	RD-95A	164	VR-D432	31
1100834			VR-D635	32	1101850	RD-08	159	VR-D678H	34
1100836			VR-D635	32	1102434			VR-D635	32
1100837			VR-D635	32	1102435			VR-D635	32
1100838			VR-D635	32	1102437			VR-D635	32
1100839			VR-D635	32	1102439			VR-D635	32
1100841			VR-D635	32	1102440			VR-D635	32
1100842			VR-D635	32	1102455			VR-D635	32
1100843			VR-D635	32	1102601	RD-95A	164		
1100845			VR-D635	32	1102617	RD-95A	164		
1100846			VR-D635	32	1102625	RD-07	159		

CROSS REFERENCE
Voltage Regulator

CROSS REFERENCE
Rectifier

CROSS REFERENCE
Diode Trio

ALTERNATOR NO.
Reg & Rec

CROSS REFERENCE LIST

OEM Alternator No. → Mobiletron No.

OEM Alternator No.	Rectifier No.	Page	Regulator No.	Page	OEM Alternator No.	Rectifier No.	Page	Regulator No.	Page
1102644	RD-95A	164			1117805	RD-17	161		
1102916	RD-09H	160	VR-D687	35	1117807	RD-17H	161		
1102918			VR-D696B	36	1117818	RD-17	161		
1102919			VR-D687	35	1117880	RD-05	159	VR-D680	34
1102921	RD-09	160			1117885			VR-D669C	33
1102934	RD-09H	160	VR-D687	35	1117886	RD-06	159	VR-D680	34
1102935	RD-09	160			1117887			VR-D669C	33
1102943			VR-D635	32	1117890			VR-D680	34
1102944			VR-D635	32	1117891			VR-D669C	33
1102945			VR-D635	32	1117892	RD-06	159	VR-D680	34
1103116	RD-09H	160			1117894	RD-05	159	VR-D680	34
1103123	RD-09	160	VR-D687	35	1117895	RD-06A	159	VR-D680	34
1103129	RD-09	160			1117903	RD-06A	159		
1103190	RD-09H	160			1117903			VR-D686	35
1105085	RD-15	161			1117903			VR-D680	34
1105366			VR-D677	34	1117905			VR-D680	34
1105367	RD-12	160			1117905			VR-D686	35
1105402			VR-D677	34	1117906			VR-D680	34
1105425	RD-13HV	160			1117909			VR-D686	35
1105428	RD-13HV	160			1117910	RD-05	159	VR-D680	34
1105440	RD-12	160			1117913			VR-D686	35
1105442			VR-D677	34	1117914			VR-D686	35
1105445			VR-D677	34	1117914			VR-D680	34
1105448			VR-D677	34	1117916			VR-D686	35
1105450	RD-15	161			1117917			VR-D686	35
1105451	RD-15H	161			1117917			VR-D680	34
1105472	RD-17	161			1117918			VR-D686	35
1105475			VR-D672C	33	1117919			VR-D680	34
1105477	RD-17	161			1117923	RD-05	159		
1105480			VR-D677	34	1117925			VR-D680	34
1105481			VR-D677	34	1117926			VR-D682	35
1105491	RD-15	161	VR-D677	34	1117927	RD-06A	159		
1105492			VR-D677	34	1117932	RD-06A	159		
1105493	RD-13HV	160			1117936			VR-D680	34
1105499			VR-D677	34	1117937	RD-06	159		
1105505			VR-D677	34	1117939			VR-D682	35
1105513	RD-15	161			1117940			VR-D682	35
1105515			VR-D677	34	1117953	RD-05	159		
1105536	RD-12	160			1117956	RD-05	159		
1105538	RD-12	160			1117957	RD-06A	159		
1105543			VR-D677	34	1117958	RD-06A	159		
1105558			VR-D677	34	1117959	RD-06A	159		
1105571			VR-D677	34	1204012	RD-18HA	161		
1105581			VR-D677	34	1204013	RD-18H	161		
1105585	RD-05	159	VR-D677	34	1204015	RD-18HA	161		
1105595			VR-D677	34	1204018	RD-18H	161		
1105596			VR-D677	34	1204020	RD-18HA	161		
1105606			VR-D677	34	1204021	RD-18H	161		
1105618			VR-D677	34	1204040	RD-18HA	161		
1105623			VR-D677	34	1204043	RD-18H	161		
1105627			VR-D677	34	1204045	RD-18HA	161		
1105628			VR-D677	34	1204068	RD-18H	161		
1105629			VR-D677	34	1204088	RD-18HA	161		
1105630			VR-D677	34	1204095	RD-18H	161		
1105632			VR-D677	34	1204100	RD-20HA	161		
1105633			VR-D677	34	1204109	RD-18H	161		
1105648			VR-D677	34	1204112	RD-18HA	161		
1105655			VR-D677	34	1204121	RD-18H	161		
1105656			VR-D677	34	1204131	RD-20HA	161		
1105658			VR-D677	34	1204203	RD-18H	161		
1105667	RD-95A	164			1204217	RD-18HA	161		
1105680	RD-05	159	VR-D677	34	1204219	RD-20HA	161		
1105683	RD-05	159	VR-D677	34	13500186	RD-44	163	VR-D186	30
1105690	RD-05	159	VR-D677	34	13500577			VR-D583	32
1105696			VR-D677	34	13500582	RD-44	163	VR-D583	32
1105700			VR-D677	34	13502580			VR-D580	32
1105725	RD-95A	164			13502595			VR-D583	32
1117155	RD-27H	162			13579661			VR-D583	32
1117160	RD-17	161	VR-D669C	33	13579662	RD-44	163	VR-D186	30
1117160			VR-D686	35	13579663			VR-D583	32
1117163	RD-17	161	VR-D680	34	13579666	RD-44	163	VR-D583	32
1117163			VR-D686	35	13579667			VR-D583	32
1117163			VR-D669C	33	13579668	RD-44	163	VR-D583	32
1117225	RD-27H	162			13979667	RD-44	163		
1117226	RD-27H	162			15056099	RD-26HD	162		
1117227	RD-27H	162			15056100	RD-26HD	162	VR-D233	30
1117228	RD-27H	162			15062413	RD-26HD	162		
1117231	RD-27H	162			15087020			VR-D233	30
1117232	RD-28H	162			15087021			VR-D233	30
1117233	RD-27H	162			15087022	RD-26HD	162		
1117234	RD-27H	162			15087024	RD-26HD	162		
1117235	RD-28H	162			15093928			VR-D755	38
1117245	RD-28H	162			15162839	RD-26HD	162		
1117732	RD-17	161			15200109	RD-40H	163	VR-D579H	32
1117801	RD-17H	161			15200110	RD-40HA	163		

CROSS REFERENCE
Voltage Regulator

CROSS REFERENCE
Rectifier

CROSS REFERENCE
Diode Trio

ALTERNATOR NO.
Reg & Rec

CROSS REFERENCE LIST

OEM Alternator No. → Mobiletron No.

OEM Alternator No.	Rectifier No.	Page	Regulator No.	Page	OEM Alternator No.	Rectifier No.	Page	Regulator No.	Page
15200268	RD-40H	163	VR-D755	38	321424	RD-95A	164		
15226003			VR-D235	30	321425	RD-95A	164		
15263858	RD-40H	163	VR-D755	38	321430	RD-95A	164		
15750871	RD-26HD	162			321435	RD-95A	164		
15754097	RD-26HD	162	VR-D235	30	321436	RD-95A	164		
15754097A			VR-D235	30	321455	RD-95A	164		
15754097M			VR-D235	30	321457	RD-95A	164		
15754097W			VR-D235	30	321469	RD-95A	164		
15768830	RD-26HD	162			321481			VR-D681H	34
15769253	RD-26HD	162			321482			VR-D681H	34
15769254	RD-26HD	162			321485			VR-D678H	34
15845337			VR-D579H	32	321492			VR-D681H	34
15845338			VR-D579H	32	321496	RD-95A	164		
15847291			VR-D579H	32	321523	RD-95A	164		
15857608			VR-D755	38	321580			VR-D681H	34
15905871			VR-D755	38	321581			VR-D681H	34
18000002	RD-40HA	163			321648			VR-D677	34
1861166	RD-39H	163			321651			VR-D672C	33
19010105	RD-05	159			321654			VR-D687	35
19011004	RD-35A	163			3472002	RD-10	160		
19011015	RD-35A	163			3472004	RD-10	160		
19011019	RD-35A	163			3472008	RD-10	160		
19020601			VR-D740	38	3472014	RD-10	160		
19020609			VR-D740	38	3472018	RD-10	160		
19020611			VR-D740	38	3472020	RD-21	161	VR-D673C	33
19020612			VR-D740	38	3472021	RD-21H	162	VR-D673C	33
1925162			VR-D737	38	3472022	RD-10	160		
1987518			VR-D672C	33	3472023	RD-10	160	VR-D673C	33
20046			VR-D186	30	3472024	RD-10	160		
20SI			VR-D687	35	3472025	RD-10	160		
21431			VR-D740	38	3472026	RD-10	160		
21512			VR-D583	32	3472027	RD-10	160		
21514			VR-D583	32	3472028	RD-10	160	VR-D673C	33
24850			VR-D580	32	3472032	RD-10	160	VR-D673C	33
25744162	RD-26HD	162			3472033	RD-10	160	VR-D673C	33
25744163	RD-26HD	162			3472037	RD-10	160	VR-D673C	33
25744164			VR-D231	30	3472038	RD-10	160	VR-D673C	33
25744165	RD-26HD	162	VR-D231	30	3472042			VR-D673C	33
266000			VR-D740	38	3472048			VR-D673C	33
27060-02050			VR-D440	31	3472049			VR-D673C	33
27060-74200			VR-D440	31	3472050			VR-D673C	33
27SITYP200			VR-D672C	33	3472051			VR-D673C	33
27SITYPE200			VR-D687	35	3472052			VR-D673C	33
29SI			VR-D672C	33	3472053			VR-D673C	33
3027014	RD-10HV	160			3472057	RD-18HA	161	VR-D673C	33
30SI			VR-D687	35	3472058	RD-18HA	161	VR-D673C	33
31100-P8A-A01			VR-D712	37	3472059	RD-18HA	161	VR-D673C	33
31100-P8A-A02			VR-D712	37	3472060	RD-18HA	161	VR-D673C	33
3122026	RD-99	164			3472061	RD-18HA	161	VR-D673C	33
31400-85Z00	RD-41	163	VR-D717	37	3472062	RD-18HA	161	VR-D673C	33
31400-85Z01	RD-41	163			3472063	RD-21	161	VR-D673C	33
3211008	RD-97HV	164	VR-D702H	36	3472064	RD-21H	162	VR-D673C	33
3211023	RD-99	164	VR-D702H	36	3472065	RD-18HA	161	VR-D673C	33
3211025	RD-97HV	164	VR-D702H	36	3472066	RD-18HA	161	VR-D673C	33
3211026	RD-97A	164	VR-D702H	36	3472067	RD-18HA	161	VR-D673C	33
3211027	RD-97HV	164	VR-D702H	36	3472068	RD-18HA	161	VR-D673C	33
3211029			VR-D678H	34	3472069			VR-D673C	33
3211031	RD-97A	164	VR-D702H	36	3472070			VR-D673C	33
3211048	RD-97HV	164	VR-D703H	36	3472072			VR-D673C	33
3211051	RD-97A	164	VR-D702H	36	3472073			VR-D673C	33
3211068	RD-95A	164			3472074			VR-D673C	33
3211071			VR-D678H	34	3472075			VR-D673C	33
321161			VR-D635	32	3472082			VR-D673C	33
321164			VR-D635	32	3472091			VR-D673C	33
321169			VR-D635	32	3472104			VR-D674H	34
3211750			VR-D232	30	3472105			VR-D674	33
3211759			VR-D709	37	3472106			VR-D674H	34
321182			VR-D635	32	3472119			VR-D674	33
321267			VR-D677	34	3472120			VR-D674H	34
321269			VR-D677	34	3472121			VR-D674	33
321338	RD-95A	164			3472128			VR-D674H	34
321344	RD-95A	164			3472130			VR-D674	33
321348	RD-95A	164			3472134			VR-D674H	34
321349	RD-95A	164			3472135			VR-D674	33
321350	RD-95A	164			3472136			VR-D674H	34
321351	RD-95A	164			3472137			VR-D674	33
321352	RD-95A	164			3472139			VR-D674H	34
321353	RD-95A	164			3472142			VR-D674	33
321365	RD-95A	164			3472143			VR-D674H	34
321368			VR-D678H	34	3472144			VR-D674	33
321387			VR-D681H	34	3493604			VR-D674H	34
321399			VR-D681H	34	3493606			VR-D674	33
321410			VR-D681H	34	3493619			VR-D674H	34
321412			VR-D681H	34	3493621			VR-D674	33
321413			VR-D681H	34	3493634			VR-D674H	34

CROSS REFERENCE
Voltage Regulator

CROSS REFERENCE
Rectifier

CROSS REFERENCE
Diode Trio

ALTERNATOR NO.
Reg & Rec

CROSS REFERENCE LIST

OEM Alternator No. → Mobiletron No.

OEM Alternator No.	Rectifier No.	Page	Regulator No.	Page	OEM Alternator No.	Rectifier No.	Page	Regulator No.	Page
3493635			VR-D674	33	7887	RD-95A	164		
3493639			VR-D674H	34	7888	RD-95A	164		
3493641			VR-D674	33	7889	RD-95A	164		
3493644			VR-D674H	34	7890	RD-95A	164		
3493704			VR-D674	33	7891	RD-95A	164		
3493706			VR-D674H	34	7892	RD-95A	164		
3493814			VR-D701	36	7893	RD-95A	164		
3493823			VR-D701	36	7894	RD-95A	164		
3493847			VR-D701	36	7895	RD-95A	164		
3493855			VR-D701	36	7896	RD-95A	164		
3493947	RD-04B	159			8238			VR-D747HD	38
3720002	RD-10HV	160			8244			VR-D238	31
3720004	RD-10HV	160			8245			VR-D238	31
3720008	RD-10HV	160			8277			VR-D238	31
3720018	RD-10HV	160			8286			VR-D238	31
3720022	RD-10HV	160			8292	RD-40H	163	VR-D579H	32
3720023	RD-10HV	160			8293	RD-33HD	163		
3720024	RD-10HV	160			8294			VR-D719	38
3720026	RD-10HV	160			8301			VR-D755	38
3720027	RD-10HV	160			8302	RD-40H	163	VR-D755	38
3720028	RD-10HV	160			8363			VR-D481	32
3720032	RD-10HV	160			8364			VR-D481	32
3720037	RD-10HV	160			8369			VR-D481	32
37300-2E700			VR-D299	31	8400206			VR-D298	31
37300-3C610			VR-D298	31	8400320			VR-D299	31
3742106	RD-20HA	161	VR-D674H	34	8460			VR-D740	38
3742121	RD-20HA	161			8461			VR-D740	38
3742130	RD-20HA	161			8483			VR-D717	37
3742134	RD-20HA	161			8484	RD-41	163	VR-D715	37
3742137	RD-20HA	161			8486			VR-D737	38
3742144	RD-20HA	161			8489			VR-D579H	32
6204002			VR-D701	36	8543			VR-D299	31
6204006			VR-D701	36	8570			VR-D481	32
6204007			VR-D701	36	8572			VR-D481	32
6204008			VR-D701	36	8600094			VR-D295	31
6204072	RD-29	162	VR-D711	37	8600201			VR-D282	31
66215-45102			VR-D502	32	8600279			VR-D295	31
66215-45502			VR-D502	32	8600280			VR-D295	31
7287	RD-05	159			8600288			VR-D295	31
7288	RD-05	159			8600289			VR-D295	31
7800	RD-95A	164			8600307			VR-D720	38
7801	RD-95A	164			8600310			VR-D1033	30
7802	RD-95A	164			8600311			VR-D720	38
7803	RD-95A	164			8600313			VR-D720	38
7804	RD-95A	164			8600314			VR-D720	38
7805	RD-95A	164			8600316			VR-D720	38
7806	RD-95A	164			8600889			VR-D1033	30
7807	RD-95A	164			8718			VR-D1033	30
7808	RD-95A	164			8719			VR-D1033	30
7809	RD-95A	164			8750			VR-D295	31
7810	RD-95A	164			8751			VR-D295	31
7815	RD-95A	164			8752			VR-D295	31
7816	RD-95A	164			8754			VR-D295	31
7817	RD-95A	164			8755			VR-D295	31
7819	RD-95A	164			90543910	RD-29	162	VR-D711	37
7820	RD-95A	164			96408588	RD-41	163	VR-D715	37
7821	RD-95A	164			96540542	RD-37	163	VR-D717	37
7822	RD-95A	164			96838439	RD-37	163	VR-D717	37
7823	RD-95A	164			96954112			VR-D716	37
7824	RD-95A	164			96991181			VR-D737	38
7856	RD-95A	164			A0001500850			VR-D744	38
7857	RD-95A	164			A0001501650			VR-D744	38
7858	RD-95A	164			A0001501750			VR-D745	38
7859	RD-95A	164			A0001502450			VR-D745	38
7860	RD-95A	164			A0001502550			VR-D745	38
7861	RD-95A	164			ANB7001			VR-D001B	30
7865	RD-95A	164			ANB7002			VR-D001B	30
7866	RD-95A	164			ANB7003			VR-D001B	30
7867	RD-95A	164			ANB7004			VR-D001B	30
7868	RD-95A	164			CS121	RD-95A	164	VR-D694H	35
7869	RD-95A	164			CS130	RD-95A	164	VR-D683H	35
7870	RD-95A	164			CS130DALTERNATORS	RD-97A	164		
7871	RD-95A	164			CS144			VR-D675H	34
7872	RD-95A	164			JFZ1621			VR-Y002	39
7873	RD-95A	164			JFZ193			VR-Y015	39
7877	RD-95A	164			JFZ198			VR-Y015	39
7878	RD-95A	164			QY6J5			VR-D701	36
7879	RD-95A	164			UD12AB	RD-29	162		
7880	RD-95A	164			DENSO				
7881	RD-95A	164			0121000-1010	RN-32	169		
7882	RD-95A	164			0121000-1011	RN-32	169		
7883	RD-95A	164			0121000-1012	RN-32	169		
7884	RD-95A	164			0121000-2430	RN-14	167		
7885	RD-95A	164			0121000-2500	RN-12	166		
7886	RD-95A	164			0121000-2680	RN-14	167		

CROSS REFERENCE
Voltage Regulator

CROSS REFERENCE
Rectifier

CROSS REFERENCE
Diode Trio

ALTERNATOR NO.
Reg & Rec

CROSS REFERENCE LIST

OEM Alternator No. → Mobiletron No.

OEM Alternator No.	Rectifier No.	Page	Regulator No.	Page	OEM Alternator No.	Rectifier No.	Page	Regulator No.	Page
0121000-3000	RN-01	165			100211-0990			VR-H2005-29	50
0121000-3100	RN-01	165			100211-100	RN-13PL	166		
0121000-3300	RN-14	167			100211-1000	RN-13	166	VR-H2005-4A	53
0121000-3310	RN-01	165			100211-1001	RN-13PL	166	VR-H2005-4A	53
0121000-3330	RN-01	165			100211-1010	RN-13	166		
0121000-3360	RN-01	165			100211-1011			VR-H2005-4A	53
0121000-3370	RN-14	167			100211-1020	RN-13PL	166		
0121000-3380	RN-01	165			100211-1021			VR-H2005-4A	53
0121000-3390	RN-14	167			100211-1030	RN-13	166		
0121000-3400	RN-01	165			100211-1031			VR-H2005-4A	53
0121000-3410	RN-01	165			100211-104	RN-13PL	166		
0121000-3430	RN-01	165			100211-1040	RN-13	166	VR-H2005-4A	53
0121000-3440	RN-01	165			100211-1041	RN-13PL	166	VR-H2005-4A	53
0121000-3450	RN-14	167			100211-105	RN-13	166		
0121000-3480	RN-01	165			100211-1050	RN-13PL	166	VR-H2005-4A	53
0201-152-0114			VR-H2005-102B	41	100211-1060	RN-13	166	VR-H2005-4A	53
021000-0100			VR-H2005-1	41	100211-1061			VR-H2005-4A	53
021000-0150			VR-H2005-1	41	100211-1070	RN-12	166	VR-H2005-4A	53
021000-0180			VR-H2005-1	41	100211-1074			VR-H2005-4A	53
021000-0270			VR-H2005-1	41	100211-108	RN-13PL	166		
021000-0300			VR-H2005-1	41	100211-1080	RN-13	166	VR-H2005-4A	53
021000-0310			VR-H2005-1	41	100211-1081	RN-13PL	166		
021000-6510			VR-H2005-1	41	100211-1090	RN-13	166	VR-H2005-4A	53
021000-6560			VR-H2005-1	41	100211-1091	RN-13PL	166	VR-H2005-4A	53
021000-6610	RN-32	169			100211-1110			VR-H2005-4A	53
021000-6611	RN-32	169			100211-1131			VR-H2005-4A	53
021000-6630	RN-32	169			100211-1141			VR-H2005-4A	53
021000-6640	RN-32	169			100211-1170	RN-13	166		
021000-6710	RN-32	169			100211-118	RN-13PL	166		
021000-7830			VR-H2005-1	41	100211-1180	RN-13	166	VR-H2005-4A	53
021000-8050			VR-H2005-1	41	100211-1200	RN-16PL	167	VR-H2005-4A	53
021000-8230	RN-32	169			100211-1210	RN-16PL	167	VR-H2005-4A	53
021000-8231	RN-32	169			100211-1220			VR-H2005-4A	53
021000-8270	RN-31	169			100211-1230	RN-16PL	167	VR-H2005-4A	53
021000-8310	RN-31	169			100211-1260	RN-16PL	167	VR-H2005-6H	55
021000-8311	RN-31	169			100211-1270	RN-16PL	167	VR-H2005-5H	54
021000-8340	RN-31	169			100211-1271			VR-H2005-5H	54
021000-9660			VR-H2005-11	42	100211-1310	RN-16PL	167		
021000-977			VR-H2005-37A	52	100211-1320	RN-16	167	VR-H2005-4A	53
021000-983			VR-H2005-37A	52	100211-1330	RN-17	167		
02131-9153			VR-H2005-92	57	100211-1331			VR-H2005-5H	54
02131-9330	RN-66	172	VR-H2005-92	57	100211-1340	RN-16PL	167	VR-H2005-4A	53
03L 903 024			VR-H2005-226	49	100211-1350	RN-16PL	167		
03L 903 024X			VR-H2005-226	49	100211-1351			VR-H2005-8	56
04606755AC	RN-55	172			100211-1360	RN-16	167	VR-H2005-4A	53
04868431AF	RN-55	172			100211-1370	RN-16PL	167	VR-H2005-8	56
04868431AG	RN-55	172			100211-1371			VR-H2005-5H	54
059903024E			VR-H2005-218	49	100211-1380	RN-16PL	167	VR-H2005-5H	54
06E903024G			VR-H2005-218	49	100211-1400			VR-H2005-7A	56
100211-0030			VR-H2005-1	41	100211-1402			VR-H2005-14H	43
100211-0040			VR-H2005-1	41	100211-1411			VR-H2005-7A	56
100211-0050			VR-H2005-31A	51	100211-1430	RN-15PL	167		
100211-0090			VR-H2005-1	41	100211-1440	RN-13	166		
100211-0130			VR-H2005-1	41	100211-1452			VR-H2005-14H	43
100211-0181			VR-H2005-1	41	100211-1511			VR-H2005-39SE	52
100211-0190			VR-H2005-1	41	100211-1520			VR-H2005-23A	50
100211-0240			VR-H2005-1	41	100211-1540			VR-H2005-39SE	52
100211-0270			VR-H2005-3	51	100211-1550	RN-15PL	167	VR-H2005-39	52
100211-0330			VR-H2005-1	41	100211-1560	RN-15PL	167	VR-H2005-23A	50
100211-0340			VR-H2005-1	41	100211-1570	RN-15PL	167	VR-H2005-26A	50
100211-0360			VR-H2005-1	41	100211-1573	RN-41	170		
100211-0500			VR-H2005-3	51	100211-1580	RN-15PL	167	VR-H2005-39SE	52
100211-0530	RN-22	168	VR-H2005-3	51	100211-1590			VR-H2005-39SE	52
100211-0540			VR-H2005-3	51	100211-1610	RN-15PL	167	VR-H2005-39SE	52
100211-0550	RN-22	168	VR-H2005-3	51	100211-1620			VR-H2005-23A	50
100211-0560	RN-22	168	VR-H2005-3	51	100211-1630			VR-H2005-39SE	52
100211-0581			VR-H2005-29	50	100211-1650			VR-H2005-39SE	52
100211-0590	RN-22	168	VR-H2005-3	51	100211-1662			VR-H2005-39SE	52
100211-0600			VR-H2005-3	51	100211-1670	RN-26	168	VR-H2005-39	52
100211-0610			VR-H2005-3	51	100211-1680	RN-40	170	VR-H2005-39SE	52
100211-0620			VR-H2005-3	51	100211-1690			VR-H2005-39SE	52
100211-0630	RN-22	168	VR-H2005-3	51	100211-1700			VR-H2005-12	42
100211-0640			VR-H2005-3	51	100211-1720			VR-H2005-11	42
100211-0650	RN-22	168	VR-H2005-3	51	100211-1721			VR-H2005-11	42
100211-0660	RN-22	168	VR-H2005-3	51	100211-1730			VR-H2005-11	42
100211-0670	RN-22	168	VR-H2005-3	51	100211-183	RN-19	168		
100211-0680			VR-H2005-28	50	100211-1830	RN-19	168		
100211-0700			VR-H2005-3	51	100211-200	RN-13PL	166		
100211-0710			VR-H2005-3	51	100211-2000	RN-13	166		
100211-0730			VR-H2005-28	50	100211-2001	RN-13PL	166		
100211-0750			VR-H2005-3	51	100211-201	RN-13	166		
100211-0760			VR-H2005-28	50	100211-2010	RN-13PL	166	VR-H2005-9A	58
100211-0780			VR-H2005-28	50	100211-2011	RN-13	166		
100211-0870			VR-H2005-28	50	100211-202	RN-13PL	166		
100211-0930			VR-H2005-28	50	100211-2020	RN-13	166	VR-H2005-4A	53

CROSS REFERENCE
Voltage Regulator

CROSS REFERENCE
Rectifier

CROSS REFERENCE
Diode Trio

ALTERNATOR NO.
Reg & Rec

CROSS REFERENCE LIST

OEM Alternator No. → Mobiletron No.

OEM Alternator No.	Rectifier No.	Page	Regulator No.	Page	OEM Alternator No.	Rectifier No.	Page	Regulator No.	Page
100211-2021	RN-13PL	166			100211-4020			VR-H2005-15H	44
100211-2030	RN-13	166	VR-H2005-4A	53	100211-4050			VR-H2005-39SE	52
100211-205	RN-13PL	166			100211-4060			VR-H2005-39SE	52
100211-2050	RN-13	166	VR-H2005-4A	53	100211-4070	RN-15PL	167		
100211-206	RN-13PL	166			100211-4080			VR-H2005-39SE	52
100211-2060	RN-13	166	VR-H2005-4A	53	100211-4091			VR-H2005-39SE	52
100211-2061	RN-13PL	166			100211-4110			VR-H2005-25	50
100211-207	RN-13	166			100211-4130	RN-15	167	VR-H2005-24	50
100211-2070	RN-13PL	166	VR-H2005-4A	53	100211-4150	RN-15	167	VR-H2005-25	50
100211-210	RN-13	166			100211-4160			VR-H2005-23A	50
100211-2100	RN-13PL	166	VR-H2005-4A	53	100211-4170	RN-15PL	167	VR-H2005-23A	50
100211-2102	RN-13	166			100211-4180			VR-H2005-39SE	52
100211-2130			VR-H2005-32A	51	100211-4200			VR-H2005-39SE	52
100211-2140	RN-13PL	166	VR-H2005-9A	58	100211-4210			VR-H2005-39SE	52
100211-215	RN-13	166			100211-4220			VR-H2005-39SE	52
100211-2150	RN-13PL	166	VR-H2005-4A	53	100211-4230			VR-H2005-39SE	52
100211-217	RN-13	166			100211-4240			VR-H2005-39SE	52
100211-2170	RN-16	167	VR-H2005-4A	53	100211-4250			VR-H2005-39SE	52
100211-221	RN-13	166			100211-4260	RN-15PL	167	VR-H2005-24	50
100211-2210	RN-16	167	VR-H2005-4A	53	100211-4290			VR-H2005-23A	50
100211-2211	RN-41	170			100211-4320			VR-H2005-23A	50
100211-2250	RN-13	166	VR-H2005-4A	53	100211-4350	RN-15PL	167	VR-H2005-23A	50
100211-2280	RN-16PL	167	VR-H2005-4A	53	100211-4360			VR-H2005-39SE	52
100211-2302	RN-41	170			100211-4382			VR-H2005-39SE	52
100211-2330	RN-16PL	167			100211-4410			VR-H2005-23A	50
100211-2370	RN-16	167	VR-H2005-4A	53	100211-4460	RN-15PL	167	VR-H2005-39SE	52
100211-2380	RN-16PL	167	VR-H2005-4A	53	100211-4482			VR-H2005-39SE	52
100211-2400	RN-05	165	VR-H2005-4A	53	100211-4490	RN-15PL	167		
100211-2460	RN-24	168			100211-4520	RN-26	168	VR-H2005-39SE	52
100211-250	RN-13	166			100211-4528	RN-26	168		
100211-2500	RN-13PL	166	VR-H2005-4A	53	100211-454	RN-18	168		
100211-255	RN-13	166			100211-4540	RN-18	168		
100211-2550	RN-13PL	166	VR-H2005-9A	58	100211-4550			VR-H2005-39SE	52
100211-2560			VR-H2005-12	42	100211-4560			VR-H2005-39SE	52
100211-2570	RN-41	170	VR-H2005-28	50	100211-4610	RN-26	168		
100211-2630			VR-H2005-28	50	100211-4640	RN-26	168		
100211-2640			VR-H2005-12	42	100211-4650	RN-26	168		
100211-2750			VR-H2005-11	42	100211-4700			VR-H2005-39SE	52
100211-2830			VR-H2005-4A	53	100211-4740	RN-26	168		
100211-2840	RN-19	168	VR-H2005-4A	53	100211-4770	RN-26	168		
100211-2980			VR-H2005-28	50	100211-5020			VR-H2005-31A	51
100211-2990			VR-H2005-28	50	100211-5110	RN-03	165	VR-H2005-31A	51
100211-3030	RN-13	166	VR-H2005-4A	53	100211-5150	RN-03PL	165		
100211-3040	RN-13PL	166	VR-H2005-4A	53	100211-5210			VR-H2005-33A	51
100211-3050			VR-H2005-17A	46	100211-5270	RN-03	165		
100211-3060	RN-13	166	VR-H2005-4A	53	100211-5360			VR-H2005-18A	47
100211-3070	RN-13PL	166			100211-5380			VR-H2005-65	55
100211-3090	RN-13	166	VR-H2005-4A	53	100211-5450	RN-05	165		
100211-3110			VR-H2005-4A	53	100211-5480			VR-H2005-65	55
100211-3150	RN-13PL	166	VR-H2005-4A	53	100211-5620	RN-03PL	165	VR-H2005-36A	52
100211-3170	RN-13	166			100211-5760			VR-H2005-28	50
100211-3180	RN-13PL	166	VR-H2005-4A	53	100211-5850			VR-H2005-10	41
100211-3190	RN-13	166			100211-5890			VR-H2005-10	41
100211-3210	RN-13PL	166			100211-5930			VR-H2005-28	50
100211-3220	RN-16	167	VR-H2005-4A	53	100211-6110			VR-H2005-33A	51
100211-3240	RN-13	166	VR-H2005-17A	46	100211-6160	RN-10	166		
100211-3260	RN-13PL	166	VR-H2005-4A	53	100211-6170	RN-10	166		
100211-3300	RN-13	166	VR-H2005-4A	53	100211-6180			VR-H2005-18A	47
100211-3310	RN-13PL	166	VR-H2005-9A	58	100211-6200			VR-H2005-58	54
100211-3320	RN-13	166	VR-H2005-4A	53	100211-6210			VR-H2005-58	54
100211-3350	RN-13PL	166	VR-H2005-4A	53	100211-6221			VR-H2005-39SE	52
100211-3390	RN-13	166	VR-H2005-4A	53	100211-6240			VR-H2005-66	55
100211-3391			VR-H2005-17A	46	100211-6250			VR-H2005-66	55
100211-3400	RN-13PL	166			100211-6260			VR-H2005-66	55
100211-3410	RN-13	166			100211-6300	RN-49	171	VR-H2005-18A	47
100211-3430	RN-13PL	166	VR-H2005-4A	53	100211-6330			VR-H2005-18A	47
100211-3500	RN-15PL	167	VR-H2005-17A	46	100211-6340			VR-H2005-18A	47
100211-3510	RN-16PL	167	VR-H2005-4A	53	100211-6360			VR-H2005-18A	47
100211-3520	RN-13	166	VR-H2005-17A	46	100211-6420	RN-51	171		
100211-3530	RN-16PL	167	VR-H2005-4A	53	100211-6460			VR-H2005-31A	51
100211-3540	RN-16PL	167	VR-H2005-4A	53	100211-6480			VR-H2005-31A	51
100211-3550	RN-16PL	167	VR-H2005-4A	53	100211-6600	RN-15PL	167	VR-H2005-24	50
100211-3590	RN-16PL	167	VR-H2005-10	41	100211-6640			VR-H2005-39SE	52
100211-3610	RN-16PL	167	VR-H2005-4A	53	100211-6720	RN-15PL	167	VR-H2005-26A	50
100211-3630	RN-13	166	VR-H2005-4A	53	100211-6760			VR-H2005-39SE	52
100211-3660	RN-16PL	167	VR-H2005-10	41	100211-6770			VR-H2005-39SE	52
100211-3680	RN-13	166	VR-H2005-17A	46	100211-6860			VR-H2005-23A	50
100211-3690	RN-16PL	167	VR-H2005-10	41	100211-6870	RN-15PL	167		
100211-3720	RN-17	167			100211-6880	RN-15	167	VR-H2005-39SE	52
100211-3770	RN-16PL	167	VR-H2005-4A	53	100211-6890			VR-H2005-39SE	52
100211-3820	RN-16PL	167	VR-H2005-4A	53	100211-6900			VR-H2005-39SE	52
100211-3890	RN-16PL	167			100211-6920			VR-H2005-39SE	52
100211-3960	RN-16	167	VR-H2005-4A	53	100211-6990	RN-15PL	167		
100211-3970	RN-16PL	167			100211-7000	RN-13	166	VR-H2005-4A	53
100211-4003			VR-H2005-15H	44	100211-7040	RN-13PL	166		

CROSS REFERENCE
Voltage Regulator

CROSS REFERENCE
Rectifier

CROSS REFERENCE
Diode Trio

ALTERNATOR NO.
Reg & Rec

CROSS REFERENCE LIST

OEM Alternator No. → Mobiletron No.

	OEM Alternator No.	Rectifier No.	Page	Regulator No.	Page	OEM Alternator No.	Rectifier No.	Page	Regulator No.	Page
CROSS REFERENCE Voltage Regulator	100211-7050	RN-13	166	VR-H2005-4A	53	100213-0760	RN-50L	171	VR-H2005-2W	51
	100211-7060	RN-13PL	166	VR-H2005-4A	53	100213-0770	RN-50L	171		
	100211-7070	RN-13	166	VR-H2005-9A	58	100213-0790	RN-50L	171		
	100211-7100	RN-13PL	166			100213-0950	RN-50L	171	VR-H2005-2W	51
	100211-7130			VR-H2005-17A	46	100213-0960	RN-50L	171		
	100211-7140	RN-13	166	VR-H2005-17A	46	100213-0970			VR-H2005-11	42
	100211-7180	RN-13PL	166			100213-0980			VR-H2005-2	48
	100211-7240			VR-H2005-9A	58	100213-1120			VR-H2005-2W	51
	100211-7330	RN-13	166	VR-H2005-8	56	100213-1160			VR-H2005-11	42
	100211-7440	RN-13PL	166	VR-H2005-17A	46	100213-1210			VR-H2005-2	48
CROSS REFERENCE Rectifier	100211-7450	RN-13	166	VR-H2005-17A	46	100213-1290			VR-H2005-11	42
	100211-7460	RN-13PL	166	VR-H2005-4A	53	100213-1450			VR-H2005-2	48
	100211-7470			VR-H2005-33A	51	100213-1500			VR-H2005-2W	51
	100211-7500	RN-13	166	VR-H2005-9A	58	100213-2560	RN-41A	170		
	100211-7570	RN-13PL	166	VR-H2005-4A	53	101210-0910			VR-F164	45
	100211-7780	RN-12	166	VR-H2005-33A	51	101210-0920			VR-F169	45
	100211-7800	RN-13	166	VR-H2005-4A	53	101210-0921			VR-F169	45
	100211-7810	RN-13PL	166			101210-0940			VR-F161	45
	100211-7820	RN-13	166			101210-09400Q			VR-F161	45
	100211-7910	RN-12	166	VR-H2005-18A	47	101210-09403Q			VR-F161	45
CROSS REFERENCE Diode Trio	100211-7930			VR-H2005-18A	47	101210-0961			VR-F161	45
	100211-7950	RN-12	166			101210-09610Q			VR-F161	45
	100211-7951	RN-12	166			101210-0971			VR-F161	45
	100211-7952	RN-12	166			101210-09710Q			VR-F161	45
	100211-7960			VR-H2005-33A	51	101210-1720			VR-F171	45
	100211-7970	RN-13PL	166	VR-H2005-4A	53	101211-0060			VR-H2005-31A	51
	100211-7990	RN-12	166			101211-0070	RN-13PL	166	VR-H2005-31A	51
	100211-8020	RN-03	165			101211-0100			VR-H2005-30A	51
	100211-8030	RN-03PL	165	VR-H2005-17A	46	101211-0120	RN-13	166		
	100211-8050	RN-03	165	VR-H2005-17A	46	101211-0130	RN-13PL	166	VR-H2005-35	52
ALTERNATOR NO. Reg & Rec	100211-8070	RN-03PL	165	VR-H2005-17A	46	101211-0140			VR-H2005-31A	51
	100211-8090			VR-H2005-17A	46	101211-0160	RN-12	166		
	100211-8150	RN-03	165	VR-H2005-10	41	101211-0190	RN-13PL	166	VR-H2005-30A	51
	100211-8230	RN-01PL	165			101211-0210			VR-H2005-31A	51
	100211-8300	RN-03PL	165	VR-H2005-4A	53	101211-0250	RN-13	166		
	100211-8320	RN-01PL	165			101211-0270			VR-H2005-31A	51
	100211-8350			VR-H2005-17A	46	101211-0300			VR-H2005-35	52
	100211-8370	RN-01PL	165	VR-H2005-34	52	101211-0340	RN-13PL	166	VR-H2005-30A	51
	100211-8380	RN-03PL	165	VR-H2005-33A	51	101211-0350			VR-H2005-30A	51
	100211-8390	RN-03	165			101211-0380			VR-H2005-31A	51
100211-8450			VR-H2005-33A	51	101211-0390			VR-H2005-31A	51	
100211-8470			VR-H2005-33A	51	101211-0430			VR-H2005-30A	51	
100211-8480			VR-H2005-33A	51	101211-0450			VR-H2005-30A	51	
100211-8500			VR-H2005-33A	51	101211-0520			VR-H2005-30A	51	
100211-8530	RN-01PL	165			101211-0550			VR-H2005-48A	53	
100211-8540	RN-03PL	165	VR-H2005-4A	53	101211-0590	RN-13	166			
100211-8550	RN-03	165			101211-0690			VR-H2005-59	54	
100211-8560	RN-03PL	165			101211-0720			VR-H2005-48A	53	
100211-8570	RN-03	165			101211-1360	RN-26	168			
100211-8590	RN-01	165	VR-H2005-33A	51	101211-2020	RN-15	167			
100211-8620	RN-04	165	VR-H2005-34	52	101211-2130	RN-15PL	167			
100211-8630	RN-04	165	VR-H2005-34	52	101211-2310			VR-H2005-60	54	
100211-8640			VR-H2005-17A	46	101211-281			VR-H2005-187	46	
100211-8710			VR-H2005-10	41	101211-373			VR-H2005-52A	54	
100211-8740	RN-03PL	165	VR-H2005-10	41	101211-4220			VR-H2005-77	56	
100211-8750	RN-03	165			101211-4280			VR-H2005-59	54	
100211-8770	RN-03PL	165			101211-5000			VR-H2005-31A	51	
100211-8810	RN-01	165			101211-5010			VR-H2005-31A	51	
100211-8820	RN-01	165			101211-5080			VR-H2005-30A	51	
100211-8860	RN-03	165			101211-5120			VR-H2005-31A	51	
100211-8870	RN-01	165			101211-5130			VR-H2005-31A	51	
100211-8910	RN-13PL	166	VR-H2005-19A	48	101211-5150			VR-H2005-30A	51	
100211-8911	RN-03	165			101211-5160			VR-H2005-30A	51	
100211-9100			VR-H2005-19A	48	101211-5170			VR-H2005-31A	51	
100211-9330	RN-03PL	165			101211-5220	RN-01P	165			
100211-9700			VR-H2005-17A	46	101211-5370			VR-H2005-31A	51	
100211-9710	RN-13	166	VR-H2005-4A	53	101211-5380			VR-H2005-31A	51	
100211-9730	RN-13PL	166			101211-5460	RN-01PL	165	VR-H2005-31A	51	
100211-9770	RN-13	166			101211-5550	RN-01P	165	VR-H2005-31A	51	
100211-9780	RN-13PL	166			101211-5640			VR-H2005-31A	51	
100211-9840	RN-13	166			101211-5660			VR-H2005-31A	51	
100211-9890	RN-12	166			101211-5720			VR-H2005-31A	51	
100213-0080			VR-H2005-11	42	101211-5750			VR-H2005-31A	51	
100213-0130			VR-H2005-11	42	101211-5760			VR-H2005-31A	51	
100213-0200			VR-H2005-11	42	101211-5770			VR-H2005-31A	51	
100213-0220			VR-H2005-11	42	101211-5900			VR-H2005-31A	51	
100213-0230			VR-H2005-11	42	101211-5970			VR-H2005-31A	51	
100213-0250			VR-H2005-11	42	101211-7010			VR-H2005-35	52	
100213-0260			VR-H2005-11	42	101211-7060			VR-H2005-31A	51	
100213-0290			VR-H2005-11	42	101211-7090	RN-49	171			
100213-0300			VR-H2005-11	42	101211-7091	RN-49	171			
100213-0330			VR-H2005-11	42	101211-7100			VR-H2005-31A	51	
100213-0370			VR-H2005-11	42	101211-7230			VR-H2005-64A	55	
100213-0610			VR-H2005-11	42	101211-7270			VR-H2005-64A	55	
100213-0750	RN-50L	171	VR-H2005-2W	51	101211-7300			VR-H2005-46A	53	

CROSS REFERENCE LIST

OEM Alternator No. → Mobiletron No.

OEM Alternator No.	Rectifier No.	Page	Regulator No.	Page	OEM Alternator No.	Rectifier No.	Page	Regulator No.	Page
101211-7301			VR-H2005-46A	53	104210-209			VR-H2005-95	58
101211-7510			VR-H2005-31A	51	104210-2100			VR-H2005-85	56
101211-7760			VR-H2005-46A	53	104210-2160	RN-54	171		
101211-7761			VR-H2005-46A	53	104210-2341	RN-46M	170	VR-H2005-85	56
101211-7780			VR-H2005-140	42	104210-2350			VR-H2005-85	56
101211-7800	RN-49	171			104210-2360	RN-34	169	VR-H2005-85	56
101211-7892			VR-H2005-165	44	104210-2420			VR-H2005-194	47
101211-7920			VR-H2005-162B	44	104210-2450			VR-H2005-204	48
101211-858			VR-H2005-52A	54	104210-2460	RN-70	173		
101211-9010			VR-H2005-59	54	104210-2650			VR-H2005-85	56
101211-9020			VR-H2005-59	54	104210-2870			VR-H2005-193	47
101211-9230	RN-03PL	165	VR-H2005-196	47	104210-2920			VR-H2005-177	45
101211-9380			VR-H2005-40	53	104210-2930	RN-53	171	VR-H2005-96	58
101211-9390			VR-H2005-40	53	104210-3030			VR-H2005-89	57
101211-9570			VR-H2005-200	48	104210-3031			VR-H2005-89	57
101211-9820			VR-H2005-40	53	10421-0306			VR-H2005-94	58
101211-9940			VR-H2005-59	54	10421-0307			VR-H2005-94	58
101211-9960	RN-03	165	VR-H2005-31A	51	104210-309			VR-H2005-99	58
10168	RN-76	173			104210-3091			VR-H2005-99	58
102211-0730	RN-49	171			104210-3092			VR-H2005-99	58
102211-0750			VR-H2005-179	46	104210-312			VR-H2005-93	58
102211-086			VR-H2005-40A	53	104210-3170			VR-H2005-83	56
102211-087			VR-H2005-40A	53	104210-3191			VR-H2005-101	41
102211-0920	RN-08	166	VR-H2005-197	47	104210-3201			VR-H2005-164A	44
102211-1180			VR-H2005-140	42	104210-3202			VR-H2005-164A	44
102211-1260			VR-H2005-40	53	104210-3240			VR-H2005-83	56
102211-1440			VR-H2005-59	54	104210-3280			VR-H2005-104	41
102211-1471			VR-H2005-82	56	104210-3290	RN-48M	171	VR-H2005-90	57
102211-167			VR-H2005-81	56	104210-3291	RN-48M	171	VR-H2005-90	57
102211-168			VR-H2005-81	56	104210-3292	RN-48M	171	VR-H2005-90	57
102211-1780			VR-H2005-200	48	104210-3293	RN-48M	171	VR-H2005-90	57
102211-1820			VR-H2005-59	54	10421-0330			VR-H2005-94	58
102211-1830			VR-H2005-59	54	104210-3320			VR-H2005-101	41
102211-1860			VR-H2005-62A	55	10421-0338	RN-34	169		
102211-1920	RN-36	169			104210-3380			VR-H2005-91	57
102211-1990	RN-36	169			104210-3381			VR-H2005-91	57
102211-2220			VR-H2005-200	48	104210-3390			VR-H2005-91	57
102211-2221			VR-H2005-200	48	104210-3410			VR-H2005-91	57
102211-2222			VR-H2005-200	48	104210-3440			VR-H2005-91	57
102211-2223			VR-H2005-200	48	104210-345			VR-H2005-85	56
102211-2230			VR-H2005-173	45	104210-3450	RN-57	172	VR-H2005-85	56
102211-2231			VR-H2005-173	45	104210-3460			VR-H2005-91	57
102211-2232			VR-H2005-173	45	104210-3461			VR-H2005-91	57
102211-2233			VR-H2005-173	45	104210-347	RN-34	169	VR-H2005-146	43
102211-2270			VR-H2005-200	48	104210-3490			VR-H2005-91	57
102211-2310			VR-H2005-64A	55	104210-3500			VR-H2005-99	58
102211-2380	RN-36	169			104210-3511	RN-37	169	VR-H2005-88	57
102211-2480	RN-36	169			104210-3512	RN-37	169	VR-H2005-88	57
102211-2810			VR-H2005-64A	55	104210-3513	RN-37	169	VR-H2005-96	58
102211-2820			VR-H2005-151B	43	104210-3521	RN-39	170	VR-H2005-88	57
102211-5013	RN-38	169			104210-3522	RN-39	170	VR-H2005-88	57
102211-5022	RN-38	169			104210-3523	RN-39	170	VR-H2005-96	58
102211-504	RN-38	169			104210-3550			VR-H2005-171	45
102211-5070			VR-H2005-48A	53	104210-3560			VR-H2005-171	45
102211-5151	RN-38	169			104210-3601			VR-H2005-150	43
102211-5210			VR-H2005-62A	55	104210-362			VR-H2005-85	56
102211-5250			VR-H2005-62A	55	104210-365			VR-H2005-85	56
102211-5270	RN-38	169			104210-3690			VR-H2005-142	42
102211-5410			VR-H2005-62A	55	104210-3710			VR-H2005-142	42
102211-596			VR-H2005-186	46	104210-3711			VR-H2005-142	42
102211-5961	RN-38	169			104210-375			VR-H2005-85	56
102211-6010			VR-H2005-185	46	104210-3750	RN-34	169	VR-H2005-85	56
102211-8622			VR-F163	45	104210-3751	RN-34	169	VR-H2005-85	56
102211-9010			VR-H2005-59	54	104210-3770			VR-H2005-152	43
102211-9060			VR-H2005-151B	43	104210-3860			VR-H2005-91	57
102211-9820			VR-H2005-62A	55	104210-388	RN-46	170		
102211-9880			VR-H2005-62A	55	104210-389	RN-46M	170		
102410-304			VR-H2005-93	58	104210-3910	RN-88	174		
10335498			VR-H2005-163	44	104210-3920			VR-H2005-89	57
104210-8241			VR-H2005-64A	55	104210-3921			VR-H2005-89	57
104210-9010			VR-H2005-64A	55	104210-3970	RN-70	173	VR-H2005-90	57
104210-0152			VR-H2005-218	49	104210-3971	RN-70	173		
104210-1000	RN-34	169			104210-400	RN-47	171		
104210-1060			VR-H2005-193	47	104210-4010			VR-H2005-142	42
104210-1220			VR-H2005-90	57	104210-4011			VR-H2005-142	42
104210-1240	RN-47	171	VR-H2005-149	43	104210-4012			VR-H2005-142	42
104210-1350	RN-76	173			104210-403			VR-H2005-85	56
104210-1351	RN-76	173			104210-404			VR-H2005-85	56
104210-1461			VR-H2005-85	56	104210-4050			VR-H2005-176	45
104210-1470			VR-H2005-194	47	104210-4090	RN-57	172		
104210-1490			VR-H2005-190	47	104210-4091	RN-57	172		
104210-1530	RN-69	173	VR-H2005-190	47	104210-4091			VR-H2005-88	57
104210-1890			VR-H2005-203	48	104210-4150			VR-H2005-164A	44
104210-2021			VR-H2005-177	45	104210-418			VR-H2005-85	56
104210-205			VR-H2005-146	43	104210-420	RN-34	169	VR-H2005-146	43

CROSS REFERENCE
Voltage Regulator

CROSS REFERENCE
Rectifier

CROSS REFERENCE
Diode Trio

ALTERNATOR NO.
Reg & Rec

CROSS REFERENCE LIST

OEM Alternator No. → Mobiletron No.

OEM Alternator No.	Rectifier No.	Page	Regulator No.	Page	OEM Alternator No.	Rectifier No.	Page	Regulator No.	Page
104210-4220	RN-54	171	VR-H2005-101	41	104210-800			VR-H2005-64A	55
104210-423			VR-H2005-146	43	104210-801			VR-H2005-64A	55
104210-4290			VR-H2005-99	58	104210-8020			VR-H2005-64A	55
104210-4340			VR-H2005-101	41	104210-8110			VR-H2005-100	41
104210-4350			VR-H2005-101	41	104210-8181	RN-36	169		
104210-4360			VR-H2005-101	41	104210-8230			VR-H2005-100	41
104210-4370	RN-54	171	VR-H2005-101	41	104210-8240			VR-H2005-64A	55
104210-4420			VR-H2005-101	41	104210-8590	RN-36	169	VR-H2005-100	41
104210-4430			VR-H2005-101	41	104210-8850	RN-72	173		
104210-4460			VR-H2005-91	57	104210-900	RN-45H	170		
104210-4470	RN-46	170			104210-9011			VR-H2005-64A	55
104210-4471	RN-46M	170	VR-H2005-146	43	104210-9031	RN-64	172	VR-H2005-166	44
104210-448	RN-47	171			104210-9050	RN-45	170		
104210-4481			VR-H2005-99	58	104210-9340			VR-H2005-64A	55
104210-4560			VR-H2005-163	44	104210-9680			VR-H2005-107	42
104210-4640			VR-H2005-182	46	104211-0510			VR-H2005-214	49
104210-4660			VR-H2005-159	43	104211-3000	RN-76	173	VR-H2005-178	45
104210-4690			VR-H2005-99	58	104211-3010	RN-76	173		
104210-4700			VR-H2005-88	57	104211-3090			VR-H2005-198	48
104210-4733			VR-H2005-90	57	104211-3130			VR-H2005-198	48
104210-474			VR-H2005-95	58	104211-3200	RN-76	173		
104210-475			VR-H2005-95	58	104211-3201	RN-76	173		
104210-479			VR-H2005-95	58	104211-3202	RN-76	173		
104210-487			VR-H2005-146	43	104211-3290			VR-H2005-178	45
104210-4880	RN-46M	170	VR-H2005-85	56	104211-3293			VR-H2005-178	45
104210-4881	RN-46M	170	VR-H2005-85	56	104211-3313			VR-H2005-178	45
104210-4910			VR-H2005-164A	44	104211-3470	RN-81	173	VR-H2005-190	47
104210-5070			VR-H2005-163	44	104211-3501	RN-76	173	VR-H2005-156	43
104210-5300			VR-H2005-88	57	104211-3750	RN-85	174	VR-H2005-223	49
104210-533	RN-46M	170			104211-3761	RN-85	174	VR-H2005-222	49
104210-5370	RN-34	169	VR-H2005-90	57	104211-3770			VR-H2005-156	43
104210-5470			VR-H2005-90	57	104211-4080			VR-H2005-156	43
104210-5570			VR-H2005-90	57	104211-8000	RN-77	173		
104210-5640	RN-54	171			104211-8210	RN-84	173	VR-H2005-221	49
104210-5740			VR-H2005-171	45	104211-8211	RN-84	173	VR-H2005-221	49
104210-5830			VR-H2005-96	58	104211-8270			VR-H2005-203	48
104210-5850			VR-H2005-177	45	104211-8300			VR-H2005-203	48
104210-589	RN-60	172			104211-8380	RN-87	174	VR-H2005-226	49
104210-5890			VR-H2005-148	43	104211-8510			VR-H2005-203	48
104210-5900			VR-H2005-90	57	10421-3090	RN-33	169		
104210-5910			VR-H2005-149	43	11003	RN-44	170		
104210-5920			VR-H2005-149	43	11030	RN-47	171	VR-H2005-99	58
104210-5950	RN-33	169	VR-H2005-177	45	11032			VR-H2005-85	56
104210-600	RN-63	172			11034	RN-46	170	VR-H2005-85	56
104210-6001			VR-H2005-101	41	11035			VR-H2005-94	58
104210-6010	RN-63	172			11036	RN-44	170		
104210-6021			VR-H2005-184	46	11040	RN-56M	172		
104210-6040	RN-74	173	VR-H2005-184	46	11044			VR-H2005-101	41
104210-6070			VR-H2005-183	46	11046			VR-H2005-101	41
104210-6071			VR-H2005-183	46	11049			VR-H2005-173	45
104210-6072			VR-H2005-183	46	11054			VR-H2005-171	45
104210-6080	RN-67	172			11087			VR-H2005-91	57
104210-6101	RN-63	172	VR-H2005-96	58	11088			VR-H2005-85	56
104210-611	RN-63	172			11090			VR-H2005-91	57
104210-6110	RN-63	172	VR-H2005-101	41	11093			VR-H2005-176	45
104210-6120			VR-H2005-194	47	11128			VR-H2005-105	42
104210-6140	RN-59	172			11136	RN-46M	170		
104210-6160			VR-H2005-101	41	11137			VR-H2005-85	56
104210-6180	RN-67	172			11138			VR-H2005-146	43
104210-6181	RN-67	172			11139	RN-34	169	VR-H2005-146	43
104210-6182	RN-67	172	VR-H2005-213	49	11154	RN-69	173		
104210-6191			VR-H2005-188	47	11155	RN-56M	172		
104210-6220	RN-67	172	VR-H2005-177	45	11156			VR-H2005-163	44
104210-6250	RN-74	173	VR-H2005-184	46	11178	RN-54	171	VR-H2005-101	41
104210-6254			VR-H2005-184	46	11181	RN-63	172		
104210-6270	RN-67	172			11183			VR-H2005-163	44
104210-6330			VR-H2005-219	49	11191			VR-H2005-92	57
104210-6331			VR-H2005-219	49	11193	RN-66	172	VR-H2005-92	57
104210-6332			VR-H2005-219	49	11195	RN-46M	170		
104210-6333			VR-H2005-219	49	11196			VR-H2005-146	43
104210-6334			VR-H2005-219	49	11201			VR-H2005-95	58
104210-6340	RN-67	172	VR-H2005-96	58	11203	RN-36	169		
104210-6401			VR-H2005-206	48	11238	RN-57	172		
104210-6402			VR-H2005-206	48	11240	RN-53	171		
104210-6500			VR-H2005-210	49	11241	RN-56M	172		
104210-6501			VR-H2005-210	49	11243	RN-53	171		
104210-6502			VR-H2005-210	49	11251	RN-63	172		
104210-6503			VR-H2005-210	49	11290	RN-63	172	VR-H2005-96	58
104210-6504			VR-H2005-210	49	11322			VR-H2005-95	58
104210-6670	RN-67	172	VR-H2005-96	58	11323			VR-H2005-95	58
104210-6681			VR-H2005-218	49	11324			VR-H2005-146	43
104210-6721			VR-H2005-215	49	11354			VR-H2005-100	41
104210-6770	RN-82	173			11390			VR-H2005-148	43
104210-6771	RN-82	173			11391			VR-H2005-149	43
104210-6870	RN-78	173	VR-H2005-101	41	11392			VR-H2005-149	43

CROSS REFERENCE
Voltage Regulator

CROSS REFERENCE
Rectifier

CROSS REFERENCE
Diode Trio

ALTERNATOR NO.
Reg & Rec

CROSS REFERENCE LIST

OEM Alternator No. → Mobiletron No.

OEM Alternator No.	Rectifier No.	Page	Regulator No.	Page	OEM Alternator No.	Rectifier No.	Page	Regulator No.	Page
11402	RN-46M	170	VR-H2005-85	56	13958	RN-36	169		
11403			VR-H2005-85	56	13978			VR-H2005-164A	44
11405	RN-59	172			13980	RN-48	171	VR-H2005-90	57
11407	RN-34	169			13984	RN-34	169	VR-H2005-146	43
11428			VR-H2005-177	45	13994			VR-H2005-91	57
11429			VR-H2005-96	58	14487			VR-H2005-178	45
11433			VR-H2005-177	45	15139480	RN-54	171		
11434	RN-67	172			15451-99371			VR-H2005-29	50
11479			VR-H2005-204	48	15817893	RN-63	172		
11496			VR-H2005-183	46	15826299			VR-H2005-163	44
11511	RN-74	173	VR-H2005-184	46	15868747	RN-63	172		
11514	RN-34	169	VR-H2005-85	56	1610048280			VR-F171	45
11516	RN-46M	170	VR-H2005-85	56	18504-6220			VR-H2005-39	52
11532	RN-67	172			20133			VR-H2005-193	47
11534	RN-67	172			20397	RN-84	173		
11573	RN-47	171	VR-H2005-149	43	204210-3400			VR-H2005-91	57
11577	RN-46M	170	VR-H2005-85	56	20631			VR-F171	45
11591			VR-H2005-193	47	20835			VR-H2005-221	49
11594	RN-77	173			23192			VR-H2005-179	46
11596	RN-36	169	VR-H2005-100	41	23371	RN-45	170		
11598	RN-71	173			23700-KA060			VR-H2005-15H	44
11604	RN-69	173	VR-H2005-190	47	24020			VR-H2005-159	43
11622			VR-H2005-96	58	24111			VR-H2005-219	49
11624	RN-67	172			25697765			VR-H2005-94	58
11627	RN-67	172	VR-H2005-177	45	25697766			VR-H2005-94	58
11628			VR-H2005-177	45	25755840	RN-54	171		
11633			VR-H2005-59	54	25759348			VR-H2005-94	58
11670			VR-H2005-203	48	25759776			VR-H2005-94	58
11671			VR-H2005-203	48	25862643	RN-54	171		
11672			VR-H2005-203	48	27020-16010			VR-H2005-3	51
11686			VR-H2005-193	47	27020-16030			VR-H2005-3	51
11712			VR-H2005-210	49	27020-16040			VR-H2005-3	51
121000-0820	RN-41	170			27020-28010			VR-H2005-1	41
121000-4000	RN-02	165			27020-28020			VR-H2005-1	41
121000-4010	RN-02	165			27020-43060			VR-H2005-3	51
121000-4030	RN-02	165			27020-45140			VR-H2005-1	41
121000-4040	RN-02	165			27020-64080			VR-H2005-11	42
121000-4050	RN-02	165			27020-64100			VR-H2005-11	42
121000-4060	RN-02	165			27040-1240A			VR-H2005-28	50
121000-4070	RN-02	165			27040-1261A			VR-H2005-28	50
121000-4080	RN-02	165			27040-1950			VR-H2005-102B	41
121000-4090	RN-02	165			27040-1950A			VR-H2005-102B	41
121000-4130	RN-02	165			27040-54010			VR-H2005-11	42
121000-4230	RN-08	166			27040-54020			VR-H2005-11	42
121000-4250	RN-40	170			27040-54030			VR-H2005-11	42
121000-4400	RN-08	166			27040-54040			VR-H2005-11	42
12192			VR-H2005-59	54	27040-54050			VR-H2005-11	42
12317515030			VR-H2005-173	45	27040-64010			VR-H2005-11	42
12317550468			VR-H2005-184	46	27040-64020			VR-H2005-11	42
12317591268			VR-H2005-184	46	27040-64030			VR-H2005-11	42
12317591271			VR-H2005-184	46	27040-64040			VR-H2005-4A	53
12317591525			VR-H2005-183	46	27040-64050			VR-H2005-4A	53
12317591526			VR-H2005-183	46	27040-64060			VR-H2005-11	42
12317591529			VR-H2005-183	46	27040-64070			VR-H2005-2	48
12317591530			VR-H2005-183	46	27040-64080			VR-H2005-2W	51
12317605060			VR-H2005-219	49	27040-64110			VR-H2005-2	48
12317610260			VR-H2005-219	49	27040-64130			VR-H2005-2W	51
12317616119			VR-H2005-210	49	27040-64131			VR-H2005-2	48
12317616121			VR-H2005-210	49	27040-64140			VR-H2005-2W	51
12355			VR-H2005-59	54	27040-64141			VR-H2005-2	48
12471			VR-H2005-59	54	27050-1170A			VR-H2005-11	42
12474			VR-H2005-140	42	27050-1190			VR-H2005-11	42
12475			VR-H2005-162B	44	27060-0L030			VR-H2005-64A	55
12658			VR-H2005-140	42	27060-02050			VR-H2005-30A	51
12660			VR-H2005-89	57	27060-02070			VR-H2005-30A	51
126600-3960			VR-H2005-213	49	27060-03010			VR-H2005-17A	46
12777			VR-H2005-59	54	27060-0A110	RN-57	172	VR-H2005-85	56
13222929			VR-F161	45	27060-0A120			VR-H2005-85	56
13222935			VR-F161	45	27060-0A130			VR-H2005-85	56
13222936			VR-F161	45	27060-0A140			VR-H2005-85	56
13256929			VR-F163	45	27060-0C020	RN-45H	170		
13256931			VR-F161	45	27060-0C170	RN-86	174		
13256932			VR-F161	45	27060-0D010	RN-03	165	VR-H2005-31A	51
13410	RN-49	171			27060-0D170			VR-H2005-179	46
13687	RN-49	171			27060-0F020	RN-40	170		
13715			VR-H2005-46A	53	27060-0F040	RN-34	169		
13878	RN-36	169			27060-0H010	RN-36	169		
13879	RN-36	169			27060-0H090	RN-45	170		
13905			VR-H2005-93	58	27060-0H100	RN-46M	170	VR-H2005-85	56
13908			VR-H2005-165	44	27060-0H110			VR-H2005-85	56
13918			VR-H2005-99	58	27060-0L020			VR-H2005-64A	55
13919	RN-44	170	VR-H2005-94	58	27060-0L021			VR-H2005-64A	55
13925			VR-H2005-40A	53	27060-0L040			VR-H2005-64A	55
13926			VR-H2005-40A	53	27060-0L071			VR-H2005-144	42
13927			VR-H2005-93	58	27060-0M100			VR-H2005-107	42

CROSS REFERENCE
Voltage Regulator

CROSS REFERENCE
Rectifier

CROSS REFERENCE
Diode Trio

ALTERNATOR NO.
Reg & Rec

CROSS REFERENCE LIST

OEM Alternator No. → Mobiletron No.

	OEM Alternator No.	Rectifier No.	Page	Regulator No.	Page	OEM Alternator No.	Rectifier No.	Page	Regulator No.	Page
	27060-0N090			VR-H2005-178	45	27060-28012			VR-H2005-1	41
	27060-0N100			VR-H2005-198	48	27060-28020			VR-H2005-1	41
	27060-0P020	RN-34	169	VR-H2005-146	43	27060-28030			VR-H2005-3	51
	27060-0P030			VR-H2005-146	43	27060-28040			VR-H2005-1	41
	27060-0P140	RN-46M	170	VR-H2005-146	43	27060-28050	RN-20	168	VR-H2005-3	51
	27060-0P141	RN-46M	170	VR-H2005-146	43	27060-28070			VR-H2005-179	46
	27060-0P350	RN-85	174	VR-H2005-222	49	27060-28160	RN-08	166	VR-H2005-197	47
	27060-0T010			VR-F164	45	27060-28170	RN-36	169		
	27060-0T130			VR-H2005-85	56	27060-28220			VR-H2005-199	48
	27060-0T260			VR-H2005-178	45	27060-28260			VR-H2005-85	56
	27060-0T340	RN-76	173	VR-H2005-156	43	27060-28270	RN-46M	170		
	27060-0V010	RN-46	170	VR-H2005-85	56	27060-28290			VR-H2005-85	56
	27060-0V030	RN-34	169	VR-H2005-85	56	27060-28300			VR-H2005-95	58
	27060-0V060			VR-H2005-85	56	27060-28350	RN-46M	170		
	27060-0V180			VR-H2005-214	49	27060-30010			VR-H2005-64A	55
	27060-0Y130			VR-H2005-198	48	27060-30040			VR-H2005-64A	55
	27060-0Y160			VR-H2005-198	48	27060-30050			VR-H2005-64A	55
	27060-0Y190			VR-H2005-107	42	27060-30080			VR-H2005-91	57
	27060-0Y350			VR-H2005-156	43	27060-30120			VR-H2005-64A	55
	27060-10010			VR-H2005-4A	53	27060-30150			VR-H2005-64A	55
	27060-10011	RN-16PL	167	VR-H2005-17A	46	27060-30151			VR-H2005-64A	55
	27060-10030			VR-H2005-3	51	27060-31010			VR-H2005-105	42
	27060-10060	RN-16PL	167			27060-31020	RN-34	169	VR-H2005-146	43
	27060-10061	RN-16	167			27060-31021			VR-H2005-146	43
	27060-10070			VR-H2005-23A	50	27060-31061			VR-H2005-146	43
	27060-10071			VR-H2005-23A	50	27060-31090			VR-H2005-95	58
	27060-10090	RN-16PL	167			27060-31100			VR-H2005-95	58
	27060-10100			VR-H2005-23A	50	27060-31101			VR-H2005-95	58
	27060-11010	RN-16PL	167			27060-31340	RN-85	174	VR-H2005-223	49
	27060-11020			VR-H2005-17A	46	27060-34020			VR-H2005-3	51
	27060-11030			VR-H2005-17A	46	27060-34030			VR-H2005-3	51
	27060-11050	RN-16PL	167			27060-34040			VR-H2005-3	51
	27060-11060			VR-H2005-17A	46	27060-35060			VR-H2005-4A	53
	27060-11080			VR-H2005-23A	50	27060-35150			VR-H2005-30A	51
	27060-11220			VR-H2005-17A	46	27060-36090			VR-H2005-178	45
	27060-11250			VR-H2005-32A	51	27060-38021			VR-H2005-1	41
	27060-11270			VR-H2005-30A	51	27060-38032			VR-H2005-1	41
	27060-11280			VR-H2005-30A	51	27060-38050	RN-59	172		
	27060-11281			VR-H2005-31A	51	27060-41010			VR-H2005-1	41
	27060-11290			VR-H2005-30A	51	27060-41011			VR-H2005-1	41
	27060-11300			VR-H2005-30A	51	27060-42030	RN-03	165	VR-H2005-4A	53
	27060-11320			VR-H2005-30A	51	27060-43010			VR-H2005-3	51
	27060-13090			VR-H2005-4A	53	27060-43020	RN-22	168	VR-H2005-3	51
	27060-15011			VR-H2005-3	51	27060-43021	RN-22	168		
	27060-15020	RN-22	168			27060-43030	RN-20	168	VR-H2005-3	51
	27060-15040	RN-16PL	167	VR-H2005-4A	53	27060-43040	RN-22	168	VR-H2005-3	51
	27060-15080			VR-H2005-31A	51	27060-43060	RN-13PL	166	VR-H2005-4A	53
	27060-15090			VR-H2005-31A	51	27060-43062			VR-H2005-4A	53
	27060-15100			VR-H2005-30A	51	27060-43070			VR-H2005-3	51
	27060-15110			VR-H2005-30A	51	27060-43080			VR-H2005-3	51
	27060-15150			VR-H2005-31A	51	27060-43090			VR-H2005-3	51
	27060-16010	RN-13	166	VR-H2005-4A	53	27060-43100	RN-19	168		
	27060-16012	RN-13PL	166	VR-H2005-4A	53	27060-43110			VR-H2005-4A	53
	27060-16030			VR-H2005-28	50	27060-43111	RN-13	166	VR-H2005-4A	53
	27060-16040			VR-H2005-4A	53	27060-43130	RN-19	168	VR-H2005-4A	53
	27060-16050			VR-H2005-4A	53	27060-43140			VR-H2005-4A	53
	27060-16080	RN-13	166	VR-H2005-4A	53	27060-44010			VR-H2005-3	51
	27060-16082			VR-H2005-4A	53	27060-45020			VR-H2005-1	41
	27060-16091	RN-16PL	167	VR-H2005-4A	53	27060-45030			VR-H2005-1	41
	27060-16122	RN-13	166	VR-H2005-4A	53	27060-45031			VR-H2005-1	41
	27060-16131			VR-H2005-17A	46	27060-45032			VR-H2005-1	41
	27060-16140			VR-H2005-4A	53	27060-45050			VR-H2005-1	41
	27060-16160			VR-H2005-4A	53	27060-46010			VR-H2005-33A	51
	27060-16170			VR-H2005-4A	53	27060-46020			VR-H2005-33A	51
	27060-16230	RN-03PL	165	VR-H2005-17A	46	27060-50090			VR-H2005-31A	51
	27060-16260			VR-H2005-17A	46	27060-50100			VR-H2005-31A	51
	27060-16320			VR-H2005-31A	51	27060-50300			VR-H2005-64A	55
	27060-16330			VR-H2005-31A	51	27060-50340				
	27060-16340			VR-H2005-31A	51	27060-51010	RN-47	171		
	27060-17120			VR-H2005-66	55	27060-51020			VR-H2005-90	57
	27060-17160			VR-H2005-31A	51	27060-55011			VR-H2005-90	57
	27060-17180			VR-H2005-31A	51	27060-55020			VR-H2005-17A	46
	27060-20170			VR-H2005-93	58	27060-55030	RN-16PL	167		
	27060-20190			VR-H2005-93	58	27060-55050			VR-H2005-17A	46
	27060-20270			VR-H2005-85	56	27060-55070			VR-H2005-31A	51
	27060-20280			VR-H2005-85	56	27060-55080			VR-H2005-31A	51
	27060-21150	RN-36	169			27060-58150			VR-H2005-66	55
	27060-22040	RN-36	169			27060-58230			VR-H2005-66	55
	27060-22080	RN-36	169			27060-58250			VR-H2005-66	55
	27060-23010			VR-H2005-62A	55	27060-61011			VR-H2005-1	41
	27060-23020			VR-H2005-81	56	27060-61090			VR-H2005-28	50
	27060-23030			VR-H2005-81	56	27060-62040			VR-H2005-17A	46
	27060-23070			VR-H2005-62A	55	27060-62050			VR-H2005-33A	51
	27060-26010			VR-H2005-1	41	27060-62080			VR-H2005-31A	51
	27060-27030			VR-H2005-208	49	27060-62090			VR-H2005-30A	51

CROSS REFERENCE
Voltage Regulator

CROSS REFERENCE
Rectifier

CROSS REFERENCE
Diode Trio

ALTERNATOR NO.
Reg & Rec

CROSS REFERENCE LIST

OEM Alternator No. → Mobiletron No.

OEM Alternator No.	Rectifier No.	Page	Regulator No.	Page	OEM Alternator No.	Rectifier No.	Page	Regulator No.	Page
27060-62190	RN-38	169			27060-OP240	RN-34	169	VR-H2005-85	56
27060-62240			VR-H2005-64A	55	27060-16090			VR-H2005-4A	53
27060-63010			VR-H2005-3	51	29012-37800	RN-38	169	VR-H2005-77	56
27060-63020	RN-13	166	VR-H2005-4A	53	29012-37801	RN-38	169	VR-H2005-77	56
27060-63021			VR-H2005-4A	53	30659346			VR-H2005-171	45
27060-63030			VR-H2005-4A	53	30667051A			VR-H2005-176	45
27060-63040			VR-H2005-4A	53	30667103			VR-H2005-171	45
27060-63041	RN-16PL	167	VR-H2005-4A	53	30737529			VR-H2005-171	45
27060-63070			VR-H2005-28	50	31000-PH7-013			VR-H2005-9A	58
27060-63080	RN-13	166	VR-H2005-4A	53	31100-5G0-A02			VR-H2005-203	48
27060-63082	RN-13PL	166	VR-H2005-4A	53	31100-5G0-A02RM			VR-H2005-203	48
27060-63100	RN-13	166	VR-H2005-4A	53	31100-P13-0130			VR-H2005-10	41
27060-63101			VR-H2005-4A	53	31100-P2C-0030			VR-H2005-196	47
27060-63102	RN-13PL	166	VR-H2005-4A	53	31100-P2E-G01			VR-H2005-62A	55
27060-64020	RN-16PL	167			31100-P3003			VR-H2005-8	56
27060-64021	RN-16	167			31100-P39-0030			VR-H2005-10	41
27060-64100			VR-H2005-31A	51	31100-P5A-003			VR-H2005-64A	55
27060-64130			VR-H2005-31A	51	31100-P7F-00331			VR-H2005-62A	55
27060-64150			VR-H2005-31A	51	31100-PC1-004			VR-H2005-37A	52
27060-64190			VR-H2005-31A	51	31100-PC1-020			VR-H2005-37A	52
27060-64200			VR-H2005-31A	51	31100-PC1-971			VR-H2005-37A	52
27060-65030			VR-H2005-33A	51	31100-PD1-014			VR-H2005-4A	53
27060-65050			VR-H2005-31A	51	31100-PD1-024			VR-H2005-4A	53
27060-66040			VR-H2005-30A	51	31100-PD2-004			VR-H2005-4A	53
27060-70020			VR-H2005-1	41	31100-PD2-014			VR-H2005-4A	53
27060-70040			VR-H2005-3	51	31100-PD2-024	RN-13PL	166	VR-H2005-4A	53
27060-70060			VR-H2005-3	51	31100-PD2-970			VR-H2005-4A	53
27060-70062			VR-H2005-3	51	31100-PD2-973			VR-H2005-4A	53
27060-70410			VR-H2005-31A	51	31100-PD6-014	RN-13	166	VR-H2005-9A	58
27060-70430			VR-H2005-31A	51	31100-PE0-003			VR-H2005-4A	53
27060-72010	RN-13	166	VR-H2005-4A	53	31100-PE0-921			VR-H2005-4A	53
27060-72020			VR-H2005-28	50	31100-PE0-924			VR-H2005-6H	55
27060-72030			VR-H2005-28	50	31100-PE2-003			VR-H2005-4A	53
27060-72040			VR-H2005-28	50	31100-PE7-660			VR-H2005-8	56
27060-72050	RN-13PL	166	VR-H2005-4A	53	31100-PE7-661			VR-H2005-8	56
27060-72060	RN-13	166	VR-H2005-4A	53	31100-PE0-003	RN-16	167		
27060-72061	RN-13PL	166	VR-H2005-4A	53	31100-PFC-003			VR-H2005-187	46
27060-72062			VR-H2005-17A	46	31100-PG7-013			VR-H2005-8	56
27060-72070	RN-13	166	VR-H2005-4A	53	31100-PH1-004			VR-H2005-4A	53
27060-72071	RN-13PL	166	VR-H2005-17A	46	31100-PH1-014	RN-13PL	166	VR-H2005-4A	53
27060-72080			VR-H2005-23A	50	31100-PH1-024			VR-H2005-4A	53
27060-72081			VR-H2005-23A	50	31100-PH3-0243	RN-13	166	VR-H2005-9A	58
27060-72100	RN-13	166	VR-H2005-4A	53	31100-PH3-J01			VR-H2005-9A	58
27060-72101	RN-13PL	166	VR-H2005-4A	53	31100-PH5-0242	RN-13PL	166		
27060-72140			VR-H2005-23A	50	31100-PH7-004	RN-13	166	VR-H2005-9A	58
27060-72150			VR-H2005-17A	46	31100-PH7-0040	RN-13PL	166		
27060-72171			VR-H2005-17A	46	31100-PH7-013			VR-H2005-9A	58
27060-72180			VR-H2005-17A	46	31100-PH7-024			VR-H2005-9A	58
27060-72350			VR-H2005-31A	51	31100-PH7-0240	RN-13	166		
27060-72360			VR-H2005-31A	51	31100-PHJ-004			VR-H2005-9A	58
27060-72370			VR-H2005-31A	51	31100-PJ0-0633	RN-13PL	166		
27060-74010	RN-13	166			31100-PJ0-663			VR-H2005-9A	58
27060-74080			VR-H2005-17A	46	31100-PJ0-6633			VR-H2005-9A	58
27060-74090			VR-H2005-33A	51	31100-PK1-004	RN-13	166	VR-H2005-4A	53
27060-74101			VR-H2005-4A	53	31100-PK1-0147	RN-13PL	166		
27060-74170			VR-H2005-33A	51	31100-PK2-0031			VR-H2005-9A	58
27060-74180			VR-H2005-33A	51	31100-PK2-004	RN-13	166	VR-H2005-9A	58
27060-74190			VR-H2005-33A	51	31100-PK2-0146			VR-H2005-9A	58
27060-74210			VR-H2005-33A	51	31100-PK2-0241			VR-H2005-9A	58
27060-74220			VR-H2005-33A	51	31100-PK3-A011			VR-H2005-9A	58
27060-74240			VR-H2005-33A	51	31100-PK3-A020M			VR-H2005-9A	58
27060-74280			VR-H2005-33A	51	31100-PM5-A01			VR-H2005-10	41
27060-74281			VR-H2005-33A	51	31100-PM8-A01			VR-H2005-10	41
27060-74360			VR-H2005-31A	51	31100-PM8-A03			VR-H2005-10	41
27060-74370			VR-H2005-31A	51	31100-PP8-004			VR-H2005-9A	58
27060-74430			VR-H2005-31A	51	31100-PP8-0040	RN-13PL	166		
27060-74440			VR-H2005-31A	51	31100-PR3-0030	RN-13	166		
27060-74460			VR-H2005-30A	51	31100-PR4-C01			VR-H2005-19A	48
27060-75050			VR-H2005-17A	46	31100-PR5-0030	RN-13PL	166		
27060-75100			VR-H2005-30A	51	31100-PR6-0030	RN-13	166		
27060-75110			VR-H2005-31A	51	31100-PRC-0030			VR-H2005-90	57
27060-75120			VR-H2005-31A	51	31100-PT3-A51			VR-H2005-10	41
27060-75310			VR-H2005-100	41	31100-PT3-A52			VR-H2005-10	41
27060-75410			VR-H2005-100	41	31100-PY3-003	RN-10	166		
27060-75411			VR-H2005-100	41	31100-R0A-0031			VR-H2005-90	57
27060-75412			VR-H2005-100	41	31100-R40A01			VR-H2005-148	43
27060-75460	RN-34	169			31100-R40-A01	RN-60	172		
27060-75490	RN-36	169	VR-H2005-100	41	31100-R70-A01	RN-47	171	VR-H2005-149	43
27060-76180			VR-H2005-31A	51	31100-R8A-A01			VR-H2005-203	48
27060-78001	RN-13	166			31100-R8A-A01RM			VR-H2005-203	48
27060-78300	RN-13PL	166			31100-RAA-A01	RN-48	171	VR-H2005-90	57
27060-87701			VR-H2005-14H	43	31100-RAA-A03	RN-48M	171	VR-H2005-90	57
27060-87706	RN-15PL	167			31100-RAA-A04	RN-48M	171	VR-H2005-90	57
27060-87726			VR-H2005-87	57	31100-RAA-A05	RN-48M	171	VR-H2005-90	57
27060-B2030			VR-H2005-185	46	31100-RCB-Y02	RN-47	171		

CROSS REFERENCE
Voltage Regulator

CROSS REFERENCE
Rectifier

CROSS REFERENCE
Diode Trio

ALTERNATOR NO.
Reg & Rec

CROSS REFERENCE LIST

OEM Alternator No. → Mobiletron No.

OEM Alternator No.	Rectifier No.	Page	Regulator No.	Page	OEM Alternator No.	Rectifier No.	Page	Regulator No.	Page
31100-RDM-A01			VR-H2005-152	43	5233449	RN-14	167		
31100-RFE-003	RN-70	173			5233599	RN-02	165		
31100-RFE-0130	RN-70	173			5233608	RN-02	165		
31100-RGL-A01	RN-47	171			5233660	RN-02	165		
31100-RGW-A01	RN-47	171	VR-H2005-149	43	5233672	RN-14	167		
31100-RTA-003	RN-69	173	VR-H2005-90	57	5234651	RN-02	165		
31100-RTA-013	RN-69	173	VR-H2005-90	57	56028697AA	RN-55	172		
31100-RTA-023	RN-69	173			56029915AB	RN-56M	172		
31100-RTA-0230			VR-H2005-90	57	56041324	RN-40	170		
31100-RV0-A01	RN-47	171	VR-H2005-149	43	56044380AH	RN-56M	172		
31100-RWC-A01	RN-69	173			5F9T-10300BB	RN-57	172		
31100-RX0-A01RM	RN-69	173			5F9Z-10346BA	RN-57	172		
31100-RZP-G01	RN-34	169			6204256			VR-F161	45
31100-RZP-G010			VR-H2005-90	57	6204258			VR-F161	45
31400-60840			VR-H2005-26A	50	6204259			VR-F161	45
31400-60B40			VR-H2005-24	50	6204282			VR-F161	45
31400-60G11			VR-H2005-48A	53	6204283			VR-F161	45
31400-60G12			VR-H2005-48A	53	6W4T-10300AA			VR-H2005-164A	44
31400-67J00			VR-H2005-159	43	6W4Z-10346AA			VR-H2005-164A	44
31400-77E22	RN-38	169			755046801			VR-H2005-184	46
31400-77E23	RN-38	169			7616119			VR-H2005-210	49
31400-78J10	RN-63	172			7616121			VR-H2005-210	49
31400-86010			VR-H2005-26A	50	7C3T-10300EE	RN-63	172	VR-H2005-96	58
31400-86210			VR-H2005-25	50	7H4Z-10300-AC			VR-H2005-142	42
31400-86510			VR-H2005-26A	50	8602920			VR-H2005-176	45
36001463			VR-H2005-171	45	86029200			VR-H2005-176	45
37300-2F200			VR-H2005-193	47	8603496			VR-H2005-171	45
37300-3C120			VR-H2005-92	57	8-94109-911-5			VR-H2005-4A	53
37300-3C170	RN-66	172	VR-H2005-92	57	8-94120-564-4			VR-H2005-4A	53
37300-3C200	RN-54	171			8-94131-357-2	RN-13	166	VR-H2005-4A	53
37300-3F020			VR-H2005-188	47	8-94137-345-2			VR-H2005-5H	54
37300-4A310			VR-H2005-195	47	8-94408-674-0	RN-13PL	166	VR-H2005-4A	53
3M5T-10300PB			VR-H2005-96	58	8-94413-621-0	RN-16PL	167		
3M5T-10300PC	RN-37	169			8-94449-781-0			VR-H2005-24	50
3M5T-10300-PC			VR-H2005-88	57	8-94449-781-1	RN-15	167		
3M5T-10300PD	RN-37	169	VR-H2005-96	58	8-97027-568-0	RN-12	166		
3M5T-10300SC			VR-H2005-171	45	89710-97800	RN-38	169	VR-H2005-77	56
3M5T-10300SD			VR-H2005-171	45	89710-97801	RN-38	169	VR-H2005-77	56
3M5T-10300UA			VR-H2005-176	45	8-97137-345-2	RN-17	167		
3M5T-10300YB	RN-39	170			8971671570			VR-H2005-172	45
3M5T-10300YC	RN-39	170			8971671571			VR-H2005-172	45
3M5T-10300YD	RN-39	170			8971873040			VR-H2005-172	45
3M5T-10300-YD			VR-H2005-88	57	8972103730			VR-H2005-172	45
3W4T-10300AG			VR-H2005-164A	44	8973697161	RN-64	172		
3W4T-10300AH			VR-H2005-164A	44	89736-97161			VR-H2005-166	44
3W4Z-10346AA			VR-H2005-164A	44	8-97940-220-0	RN-41A	170		
421000-001	RN-29	168			8X23-10300-CB			VR-H2005-194	47
421000-002	RN-29	168			94847129	RN-03	165		
421000-004	RN-29	168			9605-1973			VR-H2005-7A	56
421000-006	RN-29	168			9605-4116			VR-H2005-7A	56
4210000120	RN-30	168			96056770			VR-H2005-25	50
421000-0150	RN-56M	172			966421-9345			VR-H2005-85	56
421000-0210	RN-55	172			9664219-345	RN-57	172		
421000-0222	RN-55	172			9664219-375	RN-34	169	VR-H2005-85	56
421000-0223	RN-55	172			9678178280			VR-H2005-221	49
421000-0225	RN-55	172			9688237380			VR-F171	45
421000-0230	RN-55	172			9806007480			VR-F171	45
421000-0260	RN-56M	172			9C2T-10300CA			VR-H2005-213	49
421000-0261	RN-56	172			9L2Z-10346A			VR-H2005-177	45
421000-0343	RN-56M	172			9L3T-10300AB	RN-33	169	VR-H2005-177	45
421000-0344	RN-56	172			9R3T-10300AA			VR-H2005-96	58
421000-0360	RN-56M	172			9R3Z-10346A			VR-H2005-96	58
421000-0410	RN-53	171			9R3Z-10346D			VR-H2005-177	45
421000-0470	RN-53	171			AH22-10300-AB			VR-H2005-194	47
421000-0530	RN-53	171			BL3T-10300BC			VR-H2005-96	58
421000-0540	RN-53	171			CHA-50			VR-H2005-10	41
421000-0541	RN-53	171			CJP-75			VR-H2005-10	41
421000-0542	RN-53	171			CSF37	RN-34	169		
421000-0552	RN-56	172			CSJ89			VR-H2005-203	48
421000-0560	RN-53	171			D2BT-10300AA	RN-72	173		
421000-0700	RN-53	171			DAN1033			VR-F163	45
421000-0810	RN-53	171			DAN1040			VR-H2005-184	46
421000-7040	RN-63	172			DAN1059			VR-H2005-171	45
421000-7041	RN-71	173			DAN1061			VR-F164	45
4606755AC	RN-55	172			DAN1071			VR-F171	45
4609999AB	RN-40	170			DAN1093			VR-H2005-198	48
4801778AF	RN-63	172			DAN1094			VR-H2005-198	48
4868431AF	RN-55	172			DAN989			VR-H2005-142	42
4868431AG	RN-55	172			KJ01-18-300	RN-49	171		
4M5T-10300-LA			VR-F169	45	KJ01-18-300A	RN-49	171		
4M5T-10300-LB			VR-F169	45	LR010513			VR-H2005-142	42
4M5T-10300-LC			VR-F169	45	LR026344			VR-H2005-142	42
4W4T-10300AA			VR-H2005-164A	44	LR027517			VR-H2005-142	42
4W4Z-10346AA			VR-H2005-164A	44	MA104210-9790	RN-83	173	VR-H2005-107	42
5233418	RN-14	167			MD604589			VR-H2005-39	52

CROSS REFERENCE LIST

OEM Alternator No. → Mobiletron No.

OEM Alternator No.	Rectifier No.	Page	Regulator No.	Page	OEM Alternator No.	Rectifier No.	Page	Regulator No.	Page
MS102211-8500			VR-H2005-179	46	5C3T-10300BA	RF-124	178		
P04801778AF	RN-63	172			5C3Z-10346BA	RF-124	178		
XR822418			VR-H2005-40A	53	6C2T-10300EB			VR-F821	61
YLE500190			VR-H2005-142	42	6C2Z-10346EA			VR-F821	61
YLE500200			VR-H2005-142	42	6C3T-10300BA	RF-124	178		
YLE500340			VR-H2005-142	42	6C3Z-10346BA	RF-124	178		
YLE500400			VR-H2005-142	42	6F2Z-10346BA	RF-125	178		
YLE500440			VR-H2005-142	42	7088-10			VR-F784H	59
FEMSA					7088-2			VR-F784H	59
4376376	RI-08H	175			7716-2			VR-F784H	59
4474933	RI-08H	175			7732-10			VR-F784H	59
63303213	RI-08H	175			7732-2			VR-F784H	59
63303780	RI-08H	175			7735-10			VR-F784H	59
9-120-330-227	RI-07H	175			7735-2			VR-F784H	59
9-120-330-292	RI-07H	175			7744-10			VR-F784H	59
9-120-330-502	RI-07H	175			7744-2			VR-F784H	59
9-120-330-505	RI-07H	175			7745-10			VR-F784H	59
9-120-330-506	RI-07H	175			7745-2			VR-F784H	59
9-120-330-522	RI-07H	175			7746-2			VR-F784H	59
9-120-330-533	RI-07H	175			8478	RF-124	178		
9-120-331-802	RI-08H	175			8529			VR-F911	61
9-120-331-805	RI-08H	175			94BB-10300AE	RF-053	176	VR-F818	61
9-120-331-806	RI-08H	175			96BB-10300AB	RF-053	176		
9-120-331-814	RI-08H	175			97BB-10300AC	RF-053	176		
9-120-331-819	RI-08H	175			98AB-10300EB	RF-113	177	VR-F910	61
9-120-331-820	RI-08H	175			98AB-10300FC	RF-103	177	VR-F910	61
9-120-331-847	RI-09H	175			98AZ-10346EA	RF-043	176	VR-F910	61
9-120-331-855	RI-08H	175			98AZ-10346FA	RF-103	177	VR-F910	61
9-120-335-217	RI-07H	175			98BB-10300CC	RF-043	176	VR-F920	61
ALB12117	RI-07H	175			A3900	RF-08HV	177		
ALB30X92	RI-07H	175			A8ZU-10300AC	RF-113	177		
ALB4077	RI-07H	175			CX1FA	RF-19H	178		
ALE242	RI-07H	175			D53F-10300AA			VR-F784H	59
ALE2422	RI-07H	175			D53F-10300BA			VR-F784H	59
ALE2423	RI-07H	175			D53F-10300DA			VR-F784H	59
ALE245	RI-07H	175			D53F-10300EA			VR-F784H	59
ALE246	RI-07H	175			D53F-10300FA			VR-F784H	59
ALS12N14	RI-08H	175			D53F-10300GA			VR-F784H	59
ALS12N47	RI-09H	175			D53F-10300HA			VR-F784H	59
ALS12N55	RI-08H	175			D53F-10346BA			VR-F784H	59
ALS24N20	RI-08H	175			D53F-10346DA			VR-F784H	59
ALS24N5	RI-08H	175			D64Z-10304A	RF-08HV	177		
ALS24NX19	RI-08H	175			D9AF-10300CA	RF-09HV	177		
ALS24NX2	RI-08H	175			D9VY-10304A	RF-08HV	177		
ALS24NX6	RI-08H	175			E1AF-10300DA			VR-F784H	59
FORD					E3TF-10300AB	RF-09HV	177		
1L8U-10300AB			VR-F910	61	E43F-10300EA			VR-F784H	59
1L8U-10300AC			VR-F910	61	E43F-10300PA			VR-F784H	59
1L8U-10300CD			VR-F930	61	E43F-10300RA			VR-F784H	59
1L8U-10300CE	RF-133	178			E43F-10346B			VR-F784H	59
1L8U-10300DD			VR-F930	61	E43F-10346BA			VR-F784H	59
1L8Z-10346AB	RF-153	178	VR-F910	61	E43Z-10346D			VR-F784H	59
1L8Z-10346CB	RF-143	178	VR-F930	61	E4LF-10300CA	RF-09HV	177		
1R3U-10300AA			VR-F901	61	E53Z-10346A			VR-F784H	59
1R3U-10300AD			VR-F901	61	E57F-10300AA			VR-F784H	59
1S41-10300BB	RF-103HV	177	VR-F910	61	E57F-10300BA			VR-F784H	59
1S7T-10300BA	RF-18HV	178			E59F-10300DA			VR-F784H	59
1S7T-10300BB	RF-18HV	178			E5TZ-10346A			VR-F784H	59
1S7T-10300BC	RF-18HV	178			E63F-10300AB			VR-F784H	59
1S7T-10300DB	RF-18HV	178			E63F-10300BB			VR-F784H	59
1S7T-10300DC	RF-18HV	178			E63F-10300CB			VR-F784H	59
20-150-01001	RF-22HV	179			E63F-10300DA			VR-F784H	59
20-150-01009			VR-F911	61	E63Z-10346A			VR-F784H	59
23852			VR-F911	61	E63Z-10346B			VR-F784H	59
2C1T-10300BB			VR-F911	61	E67F-10300CA			VR-F784H	59
2C3U-10300BB			VR-F901	61	E67F-10300DA			VR-F784H	59
2S6T-10300FA	RF-22HV	179			E67F-10300EA			VR-F784H	59
2S6T-10300FB	RF-22HV	179			E67F-10300FA			VR-F784H	59
2T1U-10300CA			VR-F911	61	E67F-10346AA			VR-F784H	59
2T1U-10300CB			VR-F911	61	E67F-10346CA			VR-F784H	59
3L74-10300AA	RF-125	178			E67Z-10346A			VR-F784H	59
3L74-10300BA	RF-125	178			E69F-10300AA			VR-F784H	59
3L74-10300BB	RF-125	178			E69F-10300BA			VR-F784H	59
3L74-10346AA	RF-125	178			E69F-10346AA			VR-F784H	59
3L7Z10346AA			VR-F931	62	E69F-10346BA			VR-F784H	59
3L7Z-10346AA	RF-125	178			E6AF-10300AA			VR-F784H	59
3L7Z10346BA			VR-F931	62	E6AF-10300BA			VR-F784H	59
3L7Z-10346BA	RF-125	178			E6DF-10300BA			VR-F784H	59
3N2110300BB	RF-19H	178			E6DF-10300CA	RF-09HV	177		
3W1U-10300BB	RF-123HV	178	VR-F910	61	E6DF-10300DA			VR-F784H	59
3W1Z-10346BARM	RF-123	178	VR-F910	61	E6DF-10300EA			VR-F784H	59
4C3T-10300AA			VR-F901	61	E6DF-10300EB			VR-F784H	59
4C3T-10300BA			VR-F901	61	E6DF-10300GA			VR-F784H	59
4C3Z-10346AA	RF-103HV	177			E6DF-10346A			VR-F784H	59
51880173			VR-F756	59	E6DF-10346CA			VR-F784H	59

CROSS REFERENCE
Voltage Regulator

CROSS REFERENCE
Rectifier

CROSS REFERENCE
Diode Trio

ALTERNATOR NO.
Reg & Rec

CROSS REFERENCE LIST

OEM Alternator No. → Mobiletron No.

OEM Alternator No.	Rectifier No.	Page	Regulator No.	Page	OEM Alternator No.	Rectifier No.	Page	Regulator No.	Page
E6DZ-10346B			VR-F784H	59	E9DF-10300BB			VR-F784H	59
E6DZ-10346C			VR-F784H	59	E9EF-10300AA			VR-F784H	59
E6EF-10300EA			VR-F784H	59	E9EF-10300BA			VR-F784H	59
E6EF-10300FA			VR-F784H	59	E9PF-10346AB			VR-F784H	59
E6EF-10300GA			VR-F784H	59	E9PF-10346BA			VR-F784H	59
E6EF-10300HA			VR-F784H	59	E9PF-10346CB			VR-F784H	59
E6EF-10300JA			VR-F784H	59	E9PZ-10346A			VR-F784H	59
E6EF-10346AA			VR-F784H	59	E9PZ-10346B			VR-F784H	59
E6EF-10346CA			VR-F784H	59	E9PZ-10346C			VR-F784H	59
E6FZ-10346C			VR-F784H	59	E9PZ-10346D			VR-F784H	59
E6RZ-10346C			VR-F784H	59	E9SF-10300BA			VR-F784H	59
E6SF-10300BA			VR-F784H	59	E9TF-10300AA	RF-09HV	177		
E6TF-10300AA			VR-F784H	59	E9UF-10300DA			VR-F784H	59
E6TF-10300BA			VR-F784H	59	F02Z-10346C			VR-F786M	60
E6TF-10300CA			VR-F784H	59	F07F-10300AA			VR-F786H	59
E6TF-10300DA			VR-F784H	59	F07U-10300AC			VR-F786M	60
E6TZ-10346A			VR-F784H	59	F09F-10300AA			VR-F786H	59
E6TZ-10346B			VR-F784H	59	F0CF-10300AA			VR-F786M	60
E6UF-10300AA			VR-F784H	59	F0CU-10300AA			VR-F786H	59
E6ZF-10300CA			VR-F784H	59	F0CU-10300AB			VR-F786M	60
E6ZZ-10346B			VR-F784H	59	F0CU-10300AC			VR-F786H	59
E73F-10300BA			VR-F784H	59	F0CZ-10346A			VR-F786M	60
E73F-10300CA			VR-F784H	59	F0CZ-10346C			VR-F786H	59
E79F-10300BA			VR-F784H	59	F0DF-10300AA			VR-F786M	60
E7AF-10300CA			VR-F784H	59	F0DF-10300BA	RF-053HV	176	VR-F786H	59
E7DF-10300GA			VR-F784H	59	F0DU-10300BB			VR-F786M	60
E7EF-10300CB			VR-F784H	59	F0DU-10300BC	RF-053	176	VR-F786H	59
E7EF-10300DB			VR-F784H	59	F0DZ-10346A			VR-F786M	60
E7EF-10300EB			VR-F784H	59	F0DZ-10346B	RF-053HV	176	VR-F786H	59
E7EF-10300FB			VR-F784H	59	F0DZ-10346C	RF-053	176	VR-F786M	60
E7EF-10300GA			VR-F784H	59	F0DZ-10346D			VR-F786H	59
E7PF-10346AA			VR-F784H	59	F0DZ-10346E	RF-053HV	176		
E7PF-10346AZ			VR-F784H	59	F0EU-10300AA			VR-F784H	59
E7PF-10346BA			VR-F784H	59	F0PF-10346AA			VR-F784H	59
E7PF-10346CA			VR-F784H	59	F0PU-10346CA			VR-F786M	60
E7PF-10346DA			VR-F784H	59	F0PU-10346DA			VR-F786H	59
E7PF-10346FA			VR-F784H	59	F0PU-10346DD			VR-F786M	60
E7PF-10346GA			VR-F784H	59	F0PU-10346MC			VR-F786H	59
E7PF-10346KA			VR-F784H	59	F0PU-10346NC			VR-F786M	60
E7PF-10346LA			VR-F784H	59	F0PZ-10300F			VR-F784H	59
E7PF-10346MA			VR-F784H	59	F0PZ-10346A			VR-F786H	59
E7PF-10346NA			VR-F784H	59	F0PZ-10346E			VR-F784H	59
E7PF-10346UA			VR-F784H	59	F0TU-10300AA	RF-09HV	177		
E7PF-10346XA			VR-F784H	59	F0VF-10300AA			VR-F786M	60
E7PY-10346A			VR-F784H	59	F0VU-10300AA			VR-F786H	59
E7PZ-10346C			VR-F784H	59	F0VY-10346A			VR-F786M	60
E7PZ-10346D			VR-F784H	59	F0VY-10346B			VR-F786H	59
E7PZ-10346E			VR-F784H	59	F13U-10300AC			VR-F786M	60
E7PZ-10346F			VR-F784H	59	F13U-10300AD			VR-F786H	59
E7PZ-10346G			VR-F784H	59	F13Z-10346A			VR-F786M	60
E7PZ-10346H			VR-F784H	59	F1DU-10300AD	RF-053	176	VR-F786H	59
E7PZ-10346J			VR-F784H	59	F1DU-10300AE			VR-F786M	60
E7PZ-10346K			VR-F784H	59	F1DZ-10346A	RF-053	176	VR-F786H	59
E7PZ-10346L			VR-F784H	59	F1DZ-10346B	RF-053	176		
E7PZ-10346M			VR-F784H	59	F1PI-1034BE			VR-F786M	60
E7PZ-10346N			VR-F784H	59	F1PU-10346AC			VR-F786H	59
E7SF-10300FA			VR-F784H	59	F1PU-10346BE			VR-F786M	60
E7SF-10300HA			VR-F784H	59	F1PU-10346E			VR-F786H	59
E7SF-10300KA			VR-F784H	59	F1SU-10300AC			VR-F786M	60
E7SF-10300LA			VR-F784H	59	F1SU-10300AD			VR-F786H	59
E7SF-10300MA			VR-F784H	59	F1SZ-10346A			VR-F786M	60
E7TF-10300BA			VR-F784H	59	F1TZ-10346B			VR-F786H	59
E7TF-10300LA			VR-F784H	59	F1VU-10300BB			VR-F786M	60
E7TF-10300MA			VR-F784H	59	F1VU-10300BC			VR-F786H	59
E7TF-10300SA			VR-F784H	59	F1VY-10346A			VR-F786M	60
E7ZF-10300BA			VR-F784H	59	F1VY-10346B			VR-F786H	59
E7ZF-10300DA			VR-F784H	59	F2TU-10300AF	RF-053	176		
E7ZF-10300EA			VR-F784H	59	F2UU-10300BE	RF-053HV	176		
E7ZF-10300FA			VR-F784H	59	F2UU-10300DC	RF-053	176		
E87F-10300AA			VR-F784H	59	F2UU-10300FA	RF-053	176		
E87F-10300BA			VR-F784H	59	F2UZ-10346B			VR-F786M	60
E87F-10300CA			VR-F784H	59	F37U-10300AA	RF-053	176		
E8EF-10300AB			VR-F784H	59	F3AU-10300AC	RF-053	176		
E8HT-10300HA			VR-F784H	59	F3AU-10300BA	RF-053	176		
E8PF-10346AA			VR-F784H	59	F3AU-10300CA	RF-053	176	VR-F811	60
E8PF-10346DA			VR-F784H	59	F3DU-10300BB	RF-053	176		
E8PZ-10346A			VR-F784H	59	F4DU-10300AA	RF-053	176		
E8PZ-10346C			VR-F784H	59	F4DU-10300BA	RF-053	176		
E8SF-10300BA			VR-F784H	59	F4DU-10300CA	RF-053	176	VR-F814	60
E8TF-10300BA			VR-F784H	59	F4DU-10300DA	RF-053	176	VR-F814	60
E8TF-10300CA			VR-F784H	59	F4PU-10300AA	RF-053	176	VR-F818	61
E97F-10300AB			VR-F784H	59	F4PU-10346BA	RF-053	176		
E97F-10300BA			VR-F784H	59	F4PU-10346DA	RF-053	176		
E99F-10300			VR-F784H	59	F4PZ-10346BRM	RF-053	176		
E99F-10300AB			VR-F784H	59	F4PZ-10346D	RF-053	176		

CROSS REFERENCE
Voltage Regulator

CROSS REFERENCE
Rectifier

CROSS REFERENCE
Diode Trio

ALTERNATOR NO.
Reg & Rec

CROSS REFERENCE LIST

OEM Alternator No. → Mobiletron No.

OEM Alternator No.	Rectifier No.	Page	Regulator No.	Page	OEM Alternator No.	Rectifier No.	Page	Regulator No.	Page
F4PZ-10346DRM	RF-053	176			F8ZU-10300BA	RF-053	176		
F4SU-10300AB	RF-053	176			FD3U-10300CA			VR-F814	60
F4ZU-10300DA	RF-053	176			GL215	RF-09H	177		
F50U-10300FC	RF-063HV	177			GL310			VR-F814	60
F58U-10300AB	RF-053	176			GL419			VR-F930	61
F5AU-10300AA	RF-053	176			GL431			VR-F930	61
F5DU-10300DB	RF-063HV	177	VR-F815	60	GL453	RF-133	178		
F5OU-10300FA	RF-063	176	VR-F815	60	GL456	RF-113	177	VR-F910	61
F5OU-10300GS	RF-063	176			GL462			VR-F910	61
F5PU-10346CA	RF-053	176			GL463	RF-133	178	VR-F930	61
F5PU-10346PA	RF-053	176			GL466	RF-133	178		
F5PZ-10346PA	RF-053	176			GL550			VR-F931	62
F5PZ-10346PARM	RF-053	176			GY1306A	RF-07H	177		
F5RU-10300BA	RF-053	176	VR-F818	61	GY-1306A	RF-08HV	177		
F5UU-10300AA	RF-053	176			GY-1327	RF-08HV	177		
F5UU-10300BA	RF-053	176			LRA2852			VR-F911	61
F60U-10300AA	RF-063HV	177			MS101210-1700			VR-F756	59
F60U-10300AB	RF-063	176			XF2U-10300AB	RF-103	177	VR-F910	61
F60Y-10346AA	RF-063HV	177			XF2U-10300BC	RF-123HV	178	VR-F910	61
F65U-10300BB	RF-053	176			XF2U-10300BD	RF-123	178	VR-F910	61
F68U-10300AD	RF-063HV	177			XF2Z-10346AA	RF-063HV	177	VR-F910	61
F68U-10300AF	RF-063	176			XF2Z-10346AARM	RF-103	177	VR-F910	61
F68U-10300AS	RF-063HV	177			XF2Z-10346BA	RF-123HV	178	VR-F910	61
F6AU-10300AA	RF-053	176			XF2Z-10346BARM	RF-123	178	VR-F910	61
F6AZ-10300A			VR-F818	61	XL2U-10300AA	RF-063HV	177		
F6DU-10300BB	RF-063HV	177	VR-F815	60	XL2Z-10346AA	RF-063	176		
F6DU-10300BD	RF-063	176			XL2Z-10346AARM	RF-063HV	177		
F6DU-10300DB	RF-063HV	177	VR-F815	60	XL3U-10300AA	RF-063	176		
F6DU-10300DC	RF-063	176			XL3U-10300AB	RF-063HV	177		
F6DU-10300DD	RF-063HV	177			XL3Z-10346AA	RF-063	176		
F6DZ-10346B	RF-063	176			XR3U-10300AA	RF-103HV	177	VR-F900	61
F6DZ-10346BRM	RF-063HV	177			XR3U-10300AB	RF-103HV	177		
F6DZ-10346D	RF-063	176			XR3U-10300AC	RF-103	177		
F6DZ-10346DRM	RF-063HV	177			XR3U1-0300AC	RF-103HV	177		
F6LU-10300CA	RF-063	176	VR-F817	60	XR3Z-10346AA	RF-103	177	VR-F900	61
F6LU-10300CB	RF-063HV	177			XR3Z-10346AARM	RF-103HV	177		
F6LU-10300CC	RF-063	176			XR8U-10300AE			VR-F910	61
F6LU-10300CD	RF-063HV	177			XR8U-10300AF			VR-F910	61
F6LU-10346A	RF-063	176			XR8U-10300CE			VR-F910	61
F6LY-10346A	RF-063HV	177			XR8Z-10346AA			VR-F910	61
F6OU-10300AA	RF-063	176			XR8Z-10346CE			VR-F910	61
F6PU-10300AA	RF-053	176			XS8Z-10346AA	RF-133	178		
F6PZ-10346B	RF-053	176			XS8Z-10346BB	RF-043	176	VR-F920	61
F6ZU-10300BB	RF-063HV	177			XS8Z-10346BBRM	RF-113	177	VR-F930	61
F6ZU-10300BC	RF-063	176	VR-F817	60	XS91-10300AE	RF-133	178		
F6ZU-10300BE	RF-063HV	177			XS91-10300BB	RF-043	176	VR-F930	61
F6ZU-10300BF	RF-063	176			XS91-10300BC	RF-113	177	VR-F930	61
F6ZU-10300BG	RF-063HV	177			XU2U-10346AA	RF-053	176		
F6ZZ-10346B	RF-063	176			XU2Z-10346AA	RF-053	176		
F6ZZ-10346BRM	RF-063HV	177			XW4U-10300AA	RF-133	178	VR-F910	61
F75U-10300CA	RF-053	176			XW4U-10300AB	RF-133	178		
F77U-10300AB	RF-063HV	177	VR-F817	60	XW4U-10300BA	RF-133	178	VR-F910	61
F77U-10300AC	RF-063	176			XW4U-10300BB	RF-133	178		
F77Z-10346AB	RF-063HV	177			XW4U-10300CC			VR-F910	61
F77Z-10346ABRM	RF-063	176			XW4U-10300CD			VR-F910	61
F78U-10300AA	RF-063HV	177			XW4U-10300CE			VR-F910	61
F78Z-10346AA	RF-063	176			XW4Z-10346AA	RF-133	178	VR-F910	61
F78Z-10346AARM	RF-063HV	177			XW4Z-10346AARM			VR-F910	61
F80U-10300CA	RF-063	176			XW4Z-10346BA	RF-133	178	VR-F910	61
F80U-10300CB	RF-063HV	177			XW4Z-10346BARM			VR-F910	61
F80Z-10346CA	RF-063	176			XW4Z-10346CC			VR-F910	61
F81U-10300BA	RF-103HV	177			XW4Z-10346CCRM			VR-F910	61
F81U-10300BC	RF-103	177	VR-F900	61	XW7U-10300AA	RF-063HV	177		
F81U-10300CC	RF-103HV	177	VR-F900	61	XW7U-10300AD	RF-063	176		
F81U-10300CD	RF-103HV	177			XW7Z-10346AA	RF-063HV	177		
F81U-10300DB	RF-103	177	VR-F900	61	XW7Z-10346AARM	RF-063	176		
F81U-10300DC	RF-103HV	177	VR-F900	61	YC1U-10300DA			VR-F911	61
F81U-10300DD	RF-103HV	177			YC1U-10346DA			VR-F911	61
F81U-10300EB	RF-103	177	VR-F900	61	YF1U-10300FA	RF-133	178		
F81U-10300GA	RF-103HV	177	VR-F900	61	YF1U-10300FB	RF-133	178		
F81Z-10346BA	RF-103HV	177	VR-F900	61	YF1Z-10346FA	RF-133	178		
F81Z-10346CA	RF-103HV	177	VR-F900	61	ZR3U-10300AB	RF-103	177		
F81Z-10346DA	RF-103HV	177	VR-F900	61					
F81Z-10346EA	RF-103HV	177	VR-F900	61					
F81Z-10346GA	RF-103HV	177	VR-F900	61					
F8AU-10300AB	RF-123	178			0214-102-0011			VR-H2001-3	63
F8AU-10300AC	RF-113	177			0214-102-0021			VR-H2001-3	63
F8AU-10300AD	RF-123HV	178			0214-102-0213			VR-H2001-3	63
F8AZ-10346AB	RF-123	178			0214-102-0214			VR-H2001-3	63
F8AZ-10346ABRM	RF-123HV	178			0214-102-0410			VR-H2001-3	63
F8PF-10346BA			VR-F784H	59	0214-102-0420			VR-H2001-3	63
F8PF-10346CB			VR-F784H	59	0214-102-0511			VR-H2001-3	63
F8RZ-10346CC	RF-113	177	VR-F930	61	0214-102-0611			VR-H2001-3	63
F8WU-10A366AA	RF-103	177			0214-102-0711			VR-H2001-3	63
F8ZU-10300AC	RF-123HV	178			0214-102-0813			VR-H2001-3	63
					0214-102-0911			VR-H2001-3	63
					0214-102-1011			VR-H2001-3	63

CROSS REFERENCE
Voltage Regulator

CROSS REFERENCE
Rectifier

CROSS REFERENCE
Diode Trio

ALTERNATOR NO.
Reg & Rec

CROSS REFERENCE LIST

OEM Alternator No. → Mobiletron No.

OEM Alternator No.	Rectifier No.	Page	Regulator No.	Page	OEM Alternator No.	Rectifier No.	Page	Regulator No.	Page
0214-102-1013			VR-H2001-3	63	12112	RH-95	190		
0214-102-1111			VR-H2001-3	63	12240	RH-113	182		
0214-102-1113			VR-H2001-3	63	123900-77210	RV-H022	191		
0214-102-1210			VR-H2001-3	63	12761	RV-H022	191		
0214-102-1220			VR-H2001-3	63	128270-77200			VR-H2000-2	66
0214-102-1230			VR-H2001-3	63	129535-77200			VR-H2000-2B	67
0214-102-1310			VR-H2001-3	63	129612-77230	RH-95	190		
0214-102-1320			VR-H2001-3	63	129772-77200			VR-H2000-2	66
0214-102-1330			VR-H2001-3	63	129795-77200			VR-H2000-2	66
0214-102-1410			VR-H2001-3	63	129930-77211			VR-H2000-72	72
0214-102-1420			VR-H2001-3	63	13275	RH-21	184		
0214-102-1510			VR-H2001-3	63	13329	RH-23	184		
0214-102-1611			VR-H2001-3	63	13474	RH-29	185		
0214-102-1711			VR-H2001-3	63	13636	RH-31	186		
0214-152-0011			VR-H2001-3	63	13637	RH-31	186		
0214-202-0030			VR-H2001-3	63	13638	RH-31	186		
0214-202-0110			VR-H2001-3	63	13639	RV-H040	192	VR-H2000-28	66
0214-202-0210			VR-H2001-3	63	13640	RH-31	186		
0214-202-0220			VR-H2001-3	63	13778	RV-H050	192		
0214-202-0230			VR-H2001-3	63	13825			VR-H2000-62	71
0214-252-0011			VR-H2001-3	63	13900			VR-H2000-62	71
0214-252-0020			VR-H2001-3	63	13939			VR-H2000-62	71
0214-302-0010			VR-H2001-3	63	13940			VR-H2000-62	71
0214-302-0040			VR-H2001-3	63	1456-18-300A	RH-16C	184		
0214-302-0050			VR-H2001-3	63	1-81200-262-2	RH-10C	182		
0214-302-0110			VR-H2001-3	63	1-81200-393-1			VR-H2000-2B	67
0214-501-0010			VR-H2001-3	63	1-81200-401-0			VR-H2000-2B	67
0214-501-0110			VR-H2001-3	63	18504-6071	RH-49	187		
0214-801-0110			VR-H2001-3	63	20217	RV-H083B	192	VR-H2000-94B	74
23100-96074			VR-H2001-3	63	21300-4Z400			VR-H2000-45	69
23100-96075			VR-H2001-3	63	23099-09W00	RH-04C	181		
23100-96077			VR-H2001-3	63	23099-29W00	RH-04N	181	VR-H2000-3	67
23100-96078			VR-H2001-3	63	23099-34W01	RH-02C	180		
23100-96174			VR-H2001-3	63	23099-36W01	RH-02	180	VR-H2000-3	67
23100-96176			VR-H2001-3	63	23099-36W02	RH-02C	180	VR-H2000-3	67
23100-96177			VR-H2001-3	63	23099-36W04	RH-02C	180	VR-H2000-3	67
23100-96263			VR-H2001-3	63	23099-C6808	RH-04N	181	VR-H2000-3A	69
23100-96265			VR-H2001-3	63	23099-C8600	RH-04N	181	VR-H2000-3A	69
23100-97068			VR-H2001-3	63	23099-R8103			VR-H2000-3	67
23100-97069			VR-H2001-3	63	23099-R8104			VR-H2000-3	67
23100-97070			VR-H2001-3	63	23099-R8109	RH-04N	181	VR-H2000-3	67
23100-97071			VR-H2001-3	63	23099-R8110	RH-04N	181		
23100-97072			VR-H2001-3	63	23099-R8111	RH-04	181	VR-H2000-3A	69
23100-97114			VR-H2001-3	63	23099-R8701	RH-04N	181		
23100-97115			VR-H2001-3	63	23099-R8702			VR-H2000-3A	69
23100-97117			VR-H2001-3	63	23099-R8741	RH-04N	181		
23100-97164			VR-H2001-3	63	23099-S9000	RH-10C	182	VR-H2000-3A	69
23100-97165			VR-H2001-3	63	23099-T9004	RH-03C	180	VR-H2000-3A	69
27040-1072			VR-H2001-3	63	23099-V1708	RH-04N	181		
27040-1091			VR-H2001-3	63	23099-W1705	RH-14C	183	VR-H2000-3	67
27040-1101			VR-H2001-3	63	23099-W5804	RH-03	180		
27040-1103			VR-H2001-3	63	23099-Z5518			VR-H2000-2B	67
27040-1111			VR-H2001-3	63	23099-Z5560	RH-10C	182	VR-H2000-2B	67
27040-1113			VR-H2001-3	63	23099-Z5561	RH-10C	182	VR-H2000-2B	67
27040-1120			VR-H2001-3	63	23099-Z5562			VR-H2000-2B	67
27040-1130			VR-H2001-3	63	23100-0100	RH-49	187		
27040-1141			VR-H2001-3	63	23100-01N06			VR-H2000-37	68
27040-1151			VR-H2001-3	63	23100-02E00			VR-H2000-21	66
27040-1160			VR-H2001-3	63	23100-02E05			VR-H2000-21	66
27040-1200			VR-H2001-3	63	23100-02N20			VR-H2000-30	68
27040-1210			VR-H2001-3	63	23100-03T03			VR-H2000-3A	69
27040-1290			VR-H2001-3	63	23100-03T04			VR-H2000-3A	69
27040-1444			VR-H2001-3	63	23100-04D10			VR-H2000-3A	69
27050-1012			VR-H2001-3	63	23100-04D11			VR-H2000-3A	69
27050-1023			VR-H2001-3	63	23100-04M00			VR-H2000-32	68
27050-1041			VR-H2001-3	63	23100-05D01	RH-113	182		
27050-1051			VR-H2001-3	63	23100-05P01			VR-H2000-6H	72
27050-1061			VR-H2001-3	63	23100-05P03			VR-H2000-6H	72
27050-1081			VR-H2001-3	63	23100-0C000			VR-H2000-16	65
27050-1130			VR-H2001-3	63	23100-0E700			VR-H2000-16	65
27050-1140			VR-H2001-3	63	23100-0E705	RH-25	185	VR-H2000-16	65
27050-1150			VR-H2001-3	63	23100-0T002	RH-94	190	VR-H2000-75B	72
27050-1160			VR-H2001-3	63	23100-0W000			VR-H2000-43	69
HITACHI					23100-0W001	RH-76	189	VR-H2000-43	69
0121400-77201			VR-H2000-2	66	23100-0W002			VR-H2000-43	69
012149277200	RH-49	187			23100-0W004			VR-H2000-43	69
012475677200	RH-49	187			23100-10G03			VR-H2000-3	67
OK012-18300			VR-H2000-52	70	23100-10G04	RH-04N	181		
OK241-18300			VR-H2000-52	70	23100-10T06			VR-H2000-3A	69
11119			VR-H2000-73	72	23100-10T07			VR-H2000-3A	69
11120			VR-H2000-85	73	23100-10W01			VR-H2000-32	68
11163	RH-91	190	VR-H2000-84	73	23100-11H00	RH-14C	183	VR-H2000-3	67
11165	RH-102	181	VR-H2000-89	73	23100-11T14			VR-H2000-3A	69
119129-77201			VR-H2000-2B	67	23100-11T15			VR-H2000-3A	69
1204158	RV-H002	190			23100-11T16			VR-H2000-30	68

CROSS REFERENCE
Voltage Regulator

CROSS REFERENCE
Rectifier

CROSS REFERENCE
Diode Trio

ALTERNATOR NO.
Reg & Rec

CROSS REFERENCE LIST

OEM Alternator No. → Mobiletron No.

OEM Alternator No.	Rectifier No.	Page	Regulator No.	Page	OEM Alternator No.	Rectifier No.	Page	Regulator No.	Page
23100-12B02	RH-22	184			23100-AU40D	RH-91	190	VR-H2000-84	73
23100-12G00			VR-H2000-32	68	23100-B9800	RH-51	187	VR-H2000-1	64
23100-12G02			VR-H2000-17	65	23100-B9801	RH-51	187	VR-H2000-1	64
23100-14P01			VR-H2000-6H	72	23100-B9802			VR-H2000-32	68
23100-15P01			VR-H2000-6H	72	23100-B9805			VR-H2000-1	64
23100-16A01	RH-04N	181			23100-C0403	RH-49	187		
23100-16N00			VR-H2000-20	66	23100-C6000	RH-49	187		
23100-17A00			VR-H2000-3	67	23100-C7101	RH-03C	180		
23100-17A01	RH-04N	181	VR-H2000-3	67	23100-C8602	RH-04C	181	VR-H2000-3A	69
23100-17C00			VR-H2000-3	67	23100-C8604	RH-04N	181	VR-H2000-3A	69
23100-17D60			VR-H2000-29BC	67	23100-D0101	RH-03	180		
23100-17S00	RH-02C	180			23100-D0201	RH-01	180	VR-H2000-32	68
23100-17S05	RH-14C	183			23100-D0800	RH-12C	183	VR-H2000-32	68
23100-18A00	RH-04C	181	VR-H2000-3	67	23100-D1700	RH-01	180	VR-H2000-32	68
23100-18A01	RH-04N	181	VR-H2000-3	67	23100-D3300	RH-12C	183	VR-H2000-32	68
23100-18G02	RH-04N	181			23100-D4405	RH-39C	186		
23100-1E400	RH-29	185			23100-EA200	RH-102	181	VR-H2000-89	73
23100-1E800	RH-32	186			23100-EA20A	RH-102	181	VR-H2000-89	73
23100-20R00			VR-H2000-32	68	23100-EA20AR	RH-102	181		
23100-27G00			VR-H2000-37	68	23100-ED500			VR-H2000-91	73
23100-29R00	RH-11C	182	VR-H2000-1	64	23100-ED50A			VR-H2000-87	73
23100-2W400			VR-H2000-62	71	23100-F6501			VR-H2000-20	66
23100-30P00			VR-H2000-20	66	23100-G3701	RH-02	180		
23100-31U01	RV-H040	192	VR-H2000-28	66	23100-G3706	RH-14C	183	VR-H2000-3	67
23100-31U02	RV-H040	192	VR-H2000-28	66	23100-G4100	RH-14C	183		
23100-34T04			VR-H2000-3A	69	23100-H0300	RH-49	187		
23100-34T05			VR-H2000-3A	69	23100-H7203	RH-49	187		
23100-37M00			VR-H2000-32	68	23100-H7205	RH-11C	182		
23100-3M200			VR-H2000-43	69	23100-H7700	RH-51	187	VR-H2000-1	64
23100-3S500	RV-H050	192	VR-H2000-44	69	23100-H7701	RH-51	187	VR-H2000-1	64
23100-3S500R	RV-H050	192			23100-H7702	RH-03C	180	VR-H2000-1	64
23100-3S501	RV-H050	192			23100-H7703	RH-03	180	VR-H2000-1	64
23100-3W400			VR-H2000-62	71	23100-JA02C	RH-91	190	VR-H2000-84	73
23100-43G08			VR-H2000-30	68	23100-K6701			VR-H2000-2B	67
23100-44G02			VR-H2000-30	68	23100-L1802	RH-49	187		
23100-4S100			VR-H2000-44	69	23100-L701	RH-77	189		
23100-4Z400	RH-103	181			23100-M0400	RH-49	187		
23100-50Y05			VR-H2000-14	64	23100-M0401	RH-49	187		
23100-50Y06	RH-24	185			23100-M0402	RH-49	187		
23100-50Y07			VR-H2000-14	64	23100-M5201			VR-H2000-3	67
23100-50Y09	RH-26	185			23100-M5960			VR-H2000-32	68
23100-51H00			VR-H2000-2B	67	23100-M6600	RH-10C	182		
23100-51S00	RH-39C	186			23100-M6601	RH-03	180	VR-H2000-1	64
23100-53A00	RH-39C	186	VR-H2000-5H	71	23100-N8500			VR-H2000-32	68
23100-54A01			VR-H2000-3	67	23100-N9502	RH-10C	182		
23100-54A02	RH-15C	183			23100-OE700			VR-H2000-14	64
23100-56C01			VR-H2000-30	68	23100-OE705			VR-H2000-14	64
23100-59S01			VR-H2000-20	66	23100-P0102	RH-49	187		
23100-5C310	RH-61	188			23100-P0111	RH-49	187		
23100-5M000	RV-H034	191			23100-P0112	RH-49	187		
23100-60U00			VR-H2000-26	66	23100-P2500	RH-50	187		
23100-61700	RH-49	187			23100-P2501	RH-50	187		
23100-64J00			VR-H2000-17	65	23100-P2506	RH-51	187	VR-H2000-1	64
23100-64J01			VR-H2000-18	65	23100-P3006			VR-H2000-32	68
23100-70F05	RH-33	186	VR-H2000-27	66	23100-P4502	RH-49	187		
23100-77A00	RH-49	187	VR-H2000-11	64	23100-Q4500	RH-49	187	VR-H2000-32	68
23100-7T402	RV-H036	191			23100-T9001	RH-10C	182		
23100-80210	RH-49	187			23100-U0100	RH-49	187		
23100-80G08			VR-H2000-17	65	23100-U0101	RH-49	187		
23100-80G09R	RH-23	184			23100-U0102	RH-49	187		
23100-80W00	RH-08C	181	VR-H2000-32	68	23100-U0103	RH-49	187		
23100-84W00			VR-H2000-1	64	23100-U5802	RH-49	187		
23100-85E00	RH-43C	187			23100-U9500	RH-50	187		
23100-85L00			VR-H2000-16	65	23100-V0100			VR-H2000-32	68
23100-86L00			VR-H2000-16	65	23100-V0101	RH-12C	183	VR-H2000-32	68
23100-88G00	RH-22	184	VR-H2000-17	65	23100-V0102	RH-01	180	VR-H2000-32	68
23100-8J000			VR-H2000-62	71	23100-V0106	RH-12C	183	VR-H2000-32	68
23100-8J100			VR-H2000-62	71	23100-V0107	RH-01	180	VR-H2000-32	68
23100-8J10A			VR-H2000-62	71	23100-V4060	RH-43C	187		
23100-8J10B			VR-H2000-62	71	23100-V4360	RH-43C	187		
23100-8S100			VR-H2000-85	73	23100-V4365	RH-43C	187		
23100-8S10A			VR-H2000-85	73	23100-V4560	RH-43C	187		
23100-90060	RH-49	187			23100-V7204	RH-15C	183		
23100-91004	RH-49	187			23100-W1802	RH-02C	180		
23100-95014			VR-H2000-2B	67	23100-W1806			VR-H2000-3	67
23100-96279			VR-H2000-2B	67	23100-W1807	RH-14C	183	VR-H2000-3	67
23100-96515			VR-H2000-2B	67	23100-W2500			VR-H2000-3	67
23100-96516			VR-H2000-2B	67	23100-W2501			VR-H2000-32	68
23100-97170			VR-H2000-2B	67	23100-W2502			VR-H2000-3	67
23100-97171			VR-H2000-2B	67	23100-W3405	RH-14C	183	VR-H2000-3	67
23100-97E01			VR-H2000-23	66	23100-W5800			VR-H2000-3	67
23100-9E000	RH-69	188	VR-H2000-44	69	23100-W5801			VR-H2000-32	68
23100-A4601	RH-49	187			23100-W5802			VR-H2000-1	64
23100-A4602	RH-49	187			23100-W5803	RH-03C	180	VR-H2000-1	64
23100-AU400	RV-H047	192	VR-H2000-84	73	23100-W5805	RH-03	180	VR-H2000-1	64

CROSS REFERENCE
Voltage Regulator

CROSS REFERENCE
Rectifier

CROSS REFERENCE
Diode Trio

ALTERNATOR NO.
Reg & Rec

CROSS REFERENCE LIST

OEM Alternator No. → Mobiletron No.

	OEM Alternator No.	Rectifier No.	Page	Regulator No.	Page	OEM Alternator No.	Rectifier No.	Page	Regulator No.	Page
CROSS REFERENCE Voltage Regulator	23100-W5806	RH-11C	182	VR-H2000-1	64	8-94411-907-2	RH-02C	180		
	23100-W5807	RH-11C	182	VR-H2000-1	64	8-94411-908-2	RH-02	180		
	23100-Z5518	RH-03C	180			8-94413-621-0			VR-H2000-12	64
	23100-Z5519			VR-H2000-2B	67	8-94419-519-1			VR-H2000-29A-2	67
	23100-Z5563			VR-H2000-2B	67	8-94428-885-3			VR-H2000-29	66
	23100-Z5605			VR-H2000-2B	67	8-94428-886-1			VR-H2000-29A-2	67
	23100-Z5606			VR-H2000-2B	67	8-94428-887-3			VR-H2000-29	66
	23700-AA000			VR-H2000-1	64	8-94431-560-0			VR-H2000-2B	67
	23700-AA00Q	RH-11C	182			8-94441-959-1			VR-H2000-29	66
	23700-AA020	RH-12C	183	VR-H2000-32	68	8-94449-054-2			VR-H2000-29C	67
CROSS REFERENCE Rectifier	23700-AA090	RH-21	184	VR-H2000-15	64	8-94449-265-0			VR-H2000-9	73
	23700-AA150	RH-40C	187	VR-H2000-19	65	8-94449-731-0			VR-H2000-9	73
	23700-AA160	RH-11C	182			8-94452-134-1			VR-H2000-29A-2	67
	23700-AA31A	RH-83	189	VR-H2000-63	71	8-94452-739-0	RH-04C	181	VR-H2000-29C	67
	23802	RV-H030	191			8-94452-739-2			VR-H2000-29	66
	2-90276-600-0			VR-H2000-48	70	8-94452-740-1			VR-H2000-29C	67
	29027-68100			VR-H2000-56	71	8-94452-740-3			VR-H2000-29	66
	29027-68200			VR-H2000-62	71	8-94472-330-0			VR-H2000-3A	69
	29027-68300	RH-82	189	VR-H2000-62	71	8-94473-148-0			VR-H2000-3A	69
	32990-53300	RH-49	187			8-94490-540			VR-H2000-29C	67
CROSS REFERENCE Diode Trio	42990-7000	RH-01C	180			8-97013-172-2			VR-H2000-3A	69
	42990-7010	RH-01	180			8-97037-724-1			VR-H2000-29A-2	67
	42990-7300	RH-01C	180			8-97039-342-0			VR-H2000-29	66
	42990-7320	RH-01	180	VR-H2000-32	68	8-97043-566-0			VR-H2000-29A-2	67
	42990-7330	RH-12C	183	VR-H2000-32	68	8-97074-611-0			VR-H2000-29	66
	42990-7340	RH-01	180	VR-H2000-32	68	8-97075-883-2	RV-H003B	190	VR-H2000-86B	73
	42990-7400	RH-12C	183	VR-H2000-32	68	8-97101-816-2			VR-H2000-48	70
	42990-7500	RH-01	180			89711-66973			VR-H2000-56	71
	42990-7600	RH-01C	180	VR-H2000-1	64	8-97120-752-0			VR-H2000-48	70
	42990-7700	RH-11C	182			8-97130-752-0	RH-67A	188		
ALTERNATOR NO. Reg & Rec	5-00181-010-0			VR-H2000-2	66	8-97130-776-0	RH-66	188	VR-H2000-48	70
	5-81200-101-1	RH-49	187			8-97148-496-0	RV-H003B	190	VR-H2000-86B	73
	5-81200-109-0	RH-49	187			8-97148-496-1	RH-74A	189	VR-H2000-86B	73
	5-81200-114-0	RH-49	187			897181891130	RV-H002	190		
	5-81200-170-0	RH-49	187			8-97189-112-3			VR-H2000-50	70
	5-81200-266-4	RH-16C	184			8971891133	RV-H002	190		
	5-81200-279-2	RH-16C	184			8971891134	RV-H002	190		
	5-81200-316-3	RH-02	180			8-97189-113-4			VR-H2000-50	70
	5-81200-330-0			VR-H2000-2B	67	8971891135	RV-H002	190		
	5-81200-335-0			VR-H2000-2B	67	8971891136	RV-H002	190		
5-81200-338-0			VR-H2000-2	66	8971891137	RV-H002	190			
581-200-338-0			VR-H2000-2	66	8971891138	RV-H002	190			
581-200-338-1			VR-H2000-2	66	89718-95490			VR-H2000-56	71	
5-81200-341-0			VR-H2000-2	66	89718-96490			VR-H2000-56	71	
5-81200-349-0			VR-H2000-2	66	89720-43320	RH-82	189	VR-H2000-62	71	
581-200-349-0			VR-H2000-2	66	89724-02702	RH-123	183			
5-81200-358-0			VR-H2000-2	66	89724-82970	RH-104	181			
581-200-358-0			VR-H2000-2	66	8-97248-914-1	RH-111	182	VR-H2000-70B	72	
5-94111-836-0	RH-02C	180			8972873923	RV-H002	190			
6240140	RV-H002	190			8-97332-502-0	RV-H017B	191	VR-H2000-70B	72	
6581-200-272-0	RH-49	187			897351-5720			VR-H2000-76B	72	
8-94111-836-0	RH-02	180			8-97351-574-0	RV-H017B	191	VR-H2000-70B	72	
8-94122-220-1	RH-02C	180			89735-53400			VR-H2000-62	71	
8-94122-267-3			VR-H2000-3A	69	89736-95070	RV-H030	191			
8-94122-488-3	RH-04N	181			8-98013-455-1			VR-H2000-76BA	72	
8-94122-488-4			VR-H2000-29	66	9202-0644			VR-H2000-13	64	
8-94128-056-2			VR-H2000-29A-2	67	9312785	RV-H002	190			
8-94136-210-0			VR-H2000-9	73	93175799	RV-H002	190			
8-94155-308-5	RH-14C	183	VR-H2000-3	67	93175944	RV-H002	190			
8-94155-309-5	RH-14C	183	VR-H2000-3	67	97189113	RV-H002	190			
8-94169-952-0	RH-02C	180			977202264			VR-H2000-62	71	
8-94170-993-0	RH-02	180			9-82200-763-0	RH-49	187			
8-94171-674-0			VR-H2000-29C	67	9-82200-764-0	RH-49	187			
8-94206-081-0	RH-49	187			9-94411-908-2	RH-02C	180			
8-94234-987-2			VR-H2000-3	67	L250G-13081	RH-121	182			
8-94234-987-3			VR-H2000-3	67	LR1100-501B	RH-63	188			
8-94238-453-2			VR-H2000-3	67	LR1100502	RV-H002	190			
8-94241-630-2	RH-02C	180			LR1100-502	RH-73	189			
8-94244-298-2	RH-02	180			LR1100502B	RV-H002	190			
8-94246-956-0			VR-H2000-3	67	LR1100-502E	RV-H002	190			
8-94246-956-1			VR-H2000-3	67	LR1100502F	RV-H002	190			
8-94246-957-0			VR-H2000-3	67	LR1100-502F	RH-68	188	VR-H2000-50	70	
8-94246-957-1			VR-H2000-3	67	LR1100502G	RV-H002	190			
8-94336-728-0			VR-H2000-3A	69	LR1100-502G	RH-68	188			
8-94342-524-0			VR-H2000-3A	69	LR1100502J	RV-H002	190			
8-94389-772-1			VR-H2000-3A	69	LR1100-502J	RH-68	188			
8-94401-793-0			VR-H2000-3	67	LR1100502K	RV-H002	190			
8-94401-793-2	RH-02C	180	VR-H2000-3	67	LR1100502L	RV-H002	190			
8-94404-636-0	RH-02C	180			LR1100-502MD	RV-H008	191			
8-94404-652-0			VR-H2000-3A	69	LR1100-503B	RH-73	189			
8-94405-044-2	RH-02	180			LR1100-503C	RH-73	189			
8-94407-184-0	RH-14C	183	VR-H2000-3	67	LR1100-503E	RH-73	189			
8-94407-185-0	RH-14C	183			LR1100504C	RV-H002	190			
8-94408-365-0			VR-H2000-3	67	LR1100504E	RV-H002	190			
8-94408-918-4	RH-14C	183	VR-H2000-3	67	LR1100-507B	RH-73	189			

CROSS REFERENCE LIST

OEM Alternator No. → Mobiletron No.

OEM Alternator No.	Rectifier No.	Page	Regulator No.	Page	OEM Alternator No.	Rectifier No.	Page	Regulator No.	Page
LR1100-507C	RH-73	189			LR140-131B	RH-17C	184	VR-H2000-3	67
LR1100-508	RV-H030	191	VR-H2000-64	71	LR140-138			VR-H2000-3	67
LR1100-508B	RH-73	189	VR-H2000-64	71	LR140-402	RH-04N	181		
LR1100-508C	RH-73	189	VR-H2000-64	71	LR140-406			VR-H2000-36	68
LR1100-508F	RH-73	189	VR-H2000-64	71	LR140-408	RH-04N	181		
LR1100-703B	RH-77	189			LR140-410F			VR-H2000-36	68
LR1100-705E			VR-H2000-62	71	LR140-415	RH-04N	181		
LR1100-710			VR-H2000-62	71	LR140-415B			VR-H2000-30	68
LR1100-710B			VR-H2000-62	71	LR140-419			VR-H2000-30	68
LR1100-711	RH-77	189			LR140-419T			VR-H2000-30	68
LR1100-711B	RH-71	189	VR-H2000-46	70	LR140-421			VR-H2000-30	68
LR1100-715	RH-93	190	VR-H2000-74	72	LR140-421T			VR-H2000-30	68
LR1100-722	RV-H034	191	VR-H2000-44	69	LR140-422T			VR-H2000-30	68
LR1100-725	RH-77	189			LR140-423F			VR-H2000-36	68
LR1100-725B	RH-77	189			LR140-721	RH-95	190	VR-H2000-72	72
LR1100-725C	RH-77	189			LR140-721B	RH-95	190	VR-H2000-72	72
LR1100-734			VR-H2000-62	71	LR140-721C	RH-95	190	VR-H2000-72	72
LR1100-734B			VR-H2000-62	71	LR150-02	RH-50	187		
LR1100-734C			VR-H2000-62	71	LR150-05	RH-49	187		
LR1110-713			VR-H2000-62	71	LR150-100			VR-H2000-37	68
LR1110-713B			VR-H2000-62	71	LR150-101B	RH-03C	180	VR-H2000-37	68
LR1110-501	RH-104	181	VR-H2000-71	72	LR150-11	RH-50	187		
LR1110-503	RH-122	183	VR-H2000-64	71	LR150-117C	RH-02C	180		
LR1110-503F			VR-H2000-64	71	LR150-11A	RH-50	187		
LR1110-504	RH-97	190			LR150-125	RH-03	180	VR-H2000-1	64
LR1110-705	RH-35	186	VR-H2000-28	66	LR150-125B	RH-03C	180	VR-H2000-37	68
LR1110-707F	RH-77	189			LR150-132B			VR-H2000-37	68
LR1110-707G	RH-77	189	VR-H2000-46	70	LR150-133			VR-H2000-3	67
LR1110-707H	RH-77	189			LR150-133B	RH-02C	180	VR-H2000-3	67
LR1110-709B	RH-77	189	VR-H2000-46	70	LR150-133C			VR-H2000-3	67
LR1110-710E			VR-H2000-46	70	LR150-133E	RH-02C	180	VR-H2000-3	67
LR1110-710F	RH-77	189			LR150-136E	RH-02C	180		
LR1110-712	RH-120	182	VR-H2000-62	71	LR150-139P	RH-04N	181		
LR1110-713C	RH-91	190	VR-H2000-84	73	LR150-140	RH-10C	182		
LR1110-713V	RH-91	190	VR-H2000-84	73	LR150-146			VR-H2000-3	67
LR1110-717			VR-H2000-62	71	LR150-146B			VR-H2000-3	67
LR1110-717B			VR-H2000-62	71	LR150-146C			VR-H2000-3	67
LR1110-721			VR-H2000-62	71	LR150-147C	RH-02C	180		
LR1110-721B			VR-H2000-62	71	LR150-148C	RH-02	180		
LR1110-721E			VR-H2000-62	71	LR150-155B	RH-02C	180	VR-H2000-3	67
LR1110-721F			VR-H2000-62	71	LR150-157B	RH-02C	180		
LR1110-724			VR-H2000-73	72	LR150-158	RH-02	180		
LR1110-724B			VR-H2000-73	72	LR150-165	RH-02C	180		
LR1110-725	RH-71	189			LR150-186C	RH-03C	180		
LR1125-702B	RH-35	186			LR150-194			VR-H2000-1	64
LR1130-701			VR-H2000-85	73	LR150-194B	RH-08C	181	VR-H2000-32	68
LR1130-703	RV-H025	191	VR-H2000-89	73	LR150-197	RH-08C	181	VR-H2000-32	68
LR1130-703A	RH-102	181	VR-H2000-89	73	LR150-197B	RH-08C	181	VR-H2000-32	68
LR1130-703B	RH-102	181	VR-H2000-89	73	LR150-201B	RH-02C	180		
LR1130-703BR	RH-102	181			LR150-202	RH-02	180		
LR1140-803			VR-H2000-91	73	LR150-203	RH-02C	180		
LR1140-803E			VR-H2000-87	73	LR150-205			VR-H2000-3	67
LR1140-806			VR-H2000-91	73	LR150-205B	RH-02C	180	VR-H2000-3	67
LR1140-807			VR-H2000-91	73	LR150-206	RH-02C	180		
LR120-123	RH-18C	184			LR150-21	RH-49	187		
LR120-15C			VR-H2000-2	66	LR150-211B	RH-02	180		
LR120-16B	RH-18C	184			LR150-212B	RH-02C	180		
LR120-23			VR-H2000-2	66	LR150-22	RH-49	187		
LR135-104	RH-18C	184	VR-H2000-34	68	LR150-23	RH-49	187		
LR135-105	RH-20C	184	VR-H2000-2	66	LR150-26	RH-49	187		
LR135-106			VR-H2000-33	68	LR150-30B			VR-H2000-32	68
LR135-115			VR-H2000-2	66	LR150-31			VR-H2000-1H	65
LR135-116	RH-18C	184	VR-H2000-2	66	LR150-35			VR-H2000-32	68
LR135-125	RH-18C	184	VR-H2000-34	68	LR150-401C	RH-04	181		
LR135-126	RH-20C	184	VR-H2000-33	68	LR150-402			VR-H2000-3	67
LR135-127	RH-18C	184	VR-H2000-34	68	LR150-402C	RH-04N	181	VR-H2000-3	67
LR135-128	RH-18C	184	VR-H2000-34	68	LR150-403	RH-04N	181	VR-H2000-3	67
LR135-30	RH-49	187			LR150-410F			VR-H2000-36	68
LR135-35	RH-49	187			LR150-415			VR-H2000-29C	67
LR135-36	RH-51	187			LR150-421C	RH-04C	181	VR-H2000-29C	67
LR135-44	RH-51	187	VR-H2000-1	64	LR150-423	RH-04C	181		
LR135-51	RH-51	187			LR150-425B	RH-04N	181	VR-H2000-30	68
LR135-53	RH-51	187			LR150-428S			VR-H2000-30	68
LR135-58B			VR-H2000-2	66	LR150-428T			VR-H2000-30	68
LR135-61			VR-H2000-32	68	LR150-430S			VR-H2000-30	68
LR135-61B			VR-H2000-1H	65	LR150-431	RV-H005A	190	VR-H2000-29	66
LR135-73	RH-49	187			LR150-432	RH-50	187	VR-H2000-29A-2	67
LR135-74	RH-20C	184			LR150-434B	RH-50	187	VR-H2000-29C	67
LR135-86F			VR-H2000-2	66	LR150-435S			VR-H2000-30	68
LR135-91			VR-H2000-34	68	LR150-435T			VR-H2000-30	68
LR135-95	RH-18C	184	VR-H2000-2	66	LR150-436			VR-H2000-3	67
LR138-01			VR-H2000-32	68	LR150-438B			VR-H2000-29A-2	67
LR140-130B			VR-H2000-3	67	LR150-439B			VR-H2000-29	66
LR140-130P	RH-04N	181	VR-H2000-3	67	LR150-443S			VR-H2000-30	68
LR140-131	RH-17C	184	VR-H2000-3	67	LR150-46			VR-H2000-32	68

CROSS REFERENCE
Voltage Regulator

CROSS REFERENCE
Rectifier

CROSS REFERENCE
Diode Trio

ALTERNATOR NO.
Reg & Rec

CROSS REFERENCE LIST

OEM Alternator No. → Mobiletron No.

OEM Alternator No.	Rectifier No.	Page	Regulator No.	Page	OEM Alternator No.	Rectifier No.	Page	Regulator No.	Page
LR150-50			VR-H2000-1	64	LR160-443			VR-H2000-29A-2	67
LR150-51			VR-H2000-32	68	LR160-444			VR-H2000-29	66
LR150-52			VR-H2000-1	64	LR160-444B			VR-H2000-29A-2	67
LR150-53			VR-H2000-32	68	LR160-446			VR-H2000-29	66
LR150-55B			VR-H2000-3	67	LR160-46			VR-H2000-32	68
LR150-58			VR-H2000-32	68	LR160-47			VR-H2000-1H	65
LR150-703			VR-H2000-12	64	LR160-502E	RV-H078	192		
LR150-704	RH-39C	186	VR-H2000-9	73	LR160-503E	RH-123	183		
LR150-704H			VR-H2000-9	73	LR160-57			VR-H2000-1	64
LR150-711	RV-H009	191	VR-H2000-24	66	LR160-61			VR-H2000-32	68
LR150-715	RH-39C	186			LR160-62			VR-H2000-1	64
LR150-79H	RH-02C	180			LR160-630C			VR-H2000-48	70
LR150-94B			VR-H2000-32	68	LR160-67H	RH-14C	183	VR-H2000-3	67
LR150-98			VR-H2000-1H	65	LR160-702B	RH-59C	188		
LR150-98B	RH-03	180	VR-H2000-1	64	LR160-703			VR-H2000-13	64
LR150-98E			VR-H2000-37	68	LR160-703B	RH-59C	188		
LR150-99	RH-03C	180	VR-H2000-1	64	LR160-708			VR-H2000-21	66
LR150-99B	RH-03	180	VR-H2000-37	68	LR160-709			VR-H2000-21	66
LR155-01			VR-H2000-2	66	LR160-710			VR-H2000-21	66
LR155-12C			VR-H2000-3	67	LR160-715			VR-H2000-5H	71
LR155-15			VR-H2000-32	68	LR160-718			VR-H2000-9	73
LR155-15C	RH-01	180	VR-H2000-32	68	LR160-718H			VR-H2000-9	73
LR155-16			VR-H2000-3	67	LR160-723	RH-23	184	VR-H2000-17	65
LR155-16B	RH-02C	180	VR-H2000-3	67	LR160-723B	RH-23	184	VR-H2000-17	65
LR155-16P	RH-04N	181	VR-H2000-35	68	LR160-724			VR-H2000-18	65
LR155-18			VR-H2000-32	68	LR160-725			VR-H2000-24	66
LR155-20			VR-H2000-2	66	LR160-726	RH-26	185	VR-H2000-24	66
LR155-23			VR-H2000-32	68	LR160-727	RV-H046	192		
LR155-24			VR-H2000-1H	65	LR160-728	RV-H036	191		
LR155-408	RH-04N	181	VR-H2000-35	68	LR160-728B	RH-65	188		
LR155-416			VR-H2000-29C	67	LR160-728C	RV-H036	191		
LR155-418B			VR-H2000-29	66	LR160-728E			VR-H2000-62	71
LR155-419B			VR-H2000-29C	67	LR160-729C			VR-H2000-48	70
LR155-502B			VR-H2000-8	72	LR160-730C	RH-67A	188	VR-H2000-48	70
LR155-502C			VR-H2000-8	72	LR160-731	RH-67A	188	VR-H2000-48	70
LR155-502E			VR-H2000-8	72	LR160-732B	RH-65	188		
LR155-503E			VR-H2000-8	72	LR160-732C	RH-65	188		
LR155-504			VR-H2000-8	72	LR160-735	RV-H022	191		
LR160-104	RH-11C	182	VR-H2000-1	64	LR160-735B	RH-92	190		
LR160-105	RH-11C	182	VR-H2000-37	68	LR160-74			VR-H2000-1H	65
LR160-107B	RH-14C	183	VR-H2000-3	67	LR160-75			VR-H2000-32	68
LR160-108B	RH-14C	183	VR-H2000-3	67	LR160-77			VR-H2000-37	68
LR160-109	RH-11C	182	VR-H2000-1	64	LR160-78	RH-11C	182	VR-H2000-1	64
LR160-109C			VR-H2000-37	68	LR160-78B	RH-11C	182	VR-H2000-1	64
LR160-110	RH-11C	182			LR160-79			VR-H2000-37	68
LR160-116	RH-12C	183			LR160-82	RH-11C	182	VR-H2000-1	64
LR160-117	RH-11C	182			LR160-82B	RH-11C	182	VR-H2000-1	64
LR160-121			VR-H2000-1	64	LR160-84	RH-11C	182	VR-H2000-1	64
LR160-124			VR-H2000-32	68	LR160-84B	RH-11C	182	VR-H2000-1	64
LR160-130	RH-01	180	VR-H2000-37	68	LR160-85B			VR-H2000-37	68
LR160-133	RH-01C	180			LR160-92C	RH-14C	183	VR-H2000-3	67
LR160-137			VR-H2000-1	64	LR160-93	RH-11C	182	VR-H2000-1	64
LR160-138			VR-H2000-32	68	LR160-96			VR-H2000-3	67
LR160-140			VR-H2000-1	64	LR160-96B			VR-H2000-3	67
LR160-140B	RH-08C	181			LR160-96C			VR-H2000-3	67
LR160-143B	RH-14C	183			LR160-96H	RH-14C	183	VR-H2000-3	67
LR160-144	RH-14C	183	VR-H2000-3	67	LR160-97			VR-H2000-3	67
LR160-146B	RH-14C	183	VR-H2000-3	67	LR160-97B	RH-14C	183	VR-H2000-3	67
LR160-147F	RH-14C	183	VR-H2000-3	67	LR160-97C			VR-H2000-3	67
LR160-148F	RH-14C	183	VR-H2000-3	67	LR165-704B	RH-40C	187	VR-H2000-19	65
LR160-151	RH-08C	181	VR-H2000-32	68	LR165-705			VR-H2000-19	65
LR160-152F	RH-14C	183	VR-H2000-3	67	LR165-707			VR-H2000-11	64
LR160-164	RH-14C	183	VR-H2000-3	67	LR165-707B	RH-40C	187	VR-H2000-11	64
LR160-166			VR-H2000-32	68	LR165-708B			VR-H2000-14	64
LR160-20			VR-H2000-1H	65	LR165-708C			VR-H2000-16	65
LR160-401	RH-04N	181	VR-H2000-3	67	LR165-711			VR-H2000-42	69
LR160-401C	RH-04N	181	VR-H2000-3	67	LR165-711B			VR-H2000-38	68
LR160-417			VR-H2000-30	68	LR165-713	RV-H004	190	VR-H2000-57	71
LR160-419			VR-H2000-29C	67	LR170-10			VR-H2000-37	68
LR160-42			VR-H2000-1	64	LR170-14	RH-11C	182	VR-H2000-1	64
LR160-421C			VR-H2000-30	68	LR170-18	RH-11C	182	VR-H2000-1	64
LR160-421F			VR-H2000-30	68	LR170-21			VR-H2000-32	68
LR160-422B	RV-H055N	192	VR-H2000-30	68	LR170-22			VR-H2000-1	64
LR160-426S			VR-H2000-30	68	LR170-401			VR-H2000-3	67
LR160-426T			VR-H2000-30	68	LR170-402	RH-15C	183		
LR160-427S			VR-H2000-30	68	LR170-404	RH-15	183	VR-H2000-3	67
LR160-427T			VR-H2000-30	68	LR170-406B	RV-H055N	192	VR-H2000-30	68
LR160-42B			VR-H2000-32	68	LR170-406E			VR-H2000-30	68
LR160-432B			VR-H2000-29	66	LR170-406F			VR-H2000-30	68
LR160-433B			VR-H2000-29A-2	67	LR170-407S			VR-H2000-30	68
LR160-433E			VR-H2000-29	66	LR170-407T			VR-H2000-30	68
LR160-434B			VR-H2000-29A-2	67	LR170-408S			VR-H2000-30	68
LR160-435E			VR-H2000-29	66	LR170-410			VR-H2000-3	67
LR160-436S			VR-H2000-30	68	LR170-412S			VR-H2000-30	68
LR160-437S			VR-H2000-30	68	LR170-412T			VR-H2000-30	68

CROSS REFERENCE
Voltage Regulator

CROSS REFERENCE
Rectifier

CROSS REFERENCE
Diode Trio

ALTERNATOR NO.
Reg & Rec

CROSS REFERENCE LIST

OEM Alternator No. → Mobiletron No.

OEM Alternator No.	Rectifier No.	Page	Regulator No.	Page	OEM Alternator No.	Rectifier No.	Page	Regulator No.	Page
LR170-413			VR-H2000-30	68	LR180-705B			VR-H2000-20	66
LR170-414B			VR-H2000-30	68	LR180-708			VR-H2000-20	66
LR170-414E			VR-H2000-30	68	LR180-710B			VR-H2000-20	66
LR170-417	RH-27	185			LR180-715	RH-40C	187	VR-H2000-5H	71
LR170-417B	RH-27C	185			LR180-719			VR-H2000-5H	71
LR170-417C	RH-27	185			LR180-721B			VR-H2000-7H	72
LR170-417E	RH-27C	185			LR180-724			VR-H2000-20	66
LR170-417F	RH-27	185			LR180-725	RH-23	184	VR-H2000-17	65
LR170-420			VR-H2000-40	69	LR180-725B	RH-29	185	VR-H2000-18	65
LR170-501C			VR-H2000-39	69	LR180-725C	RH-29	185	VR-H2000-18	65
LR170-502B			VR-H2000-39	69	LR180-725E			VR-H2000-18	65
LR170-502C	RH-60	188	VR-H2000-39	69	LR180-729			VR-H2000-17	65
LR170-503			VR-H2000-39	69	LR180-730			VR-H2000-14	64
LR170-504			VR-H2000-39	69	LR180-731B			VR-H2000-16	65
LR170-504B			VR-H2000-39	69	LR180-734B			VR-H2000-18	65
LR170-505	RV-H001	190			LR180-734C			VR-H2000-18	65
LR170-509C	RH-68	188			LR180-736B	RH-29	185	VR-H2000-18	65
LR170-509E	RH-68	188	VR-H2000-50	70	LR180-741			VR-H2000-42	69
LR170-509F	RH-68	188			LR180-741B			VR-H2000-38	68
LR170-509G	RH-68	188			LR180-741H	RH-32	186		
LR170-509H	RH-68	188			LR180-744	RV-H046	192		
LR170-511			VR-H2000-50	70	LR180-749C			VR-H2000-62	71
LR170-701			VR-H2000-6H	72	LR180-749E			VR-H2000-62	71
LR170-701B			VR-H2000-6H	72	LR180-751	RH-31	186	VR-H2000-43	69
LR170-702			VR-H2000-6H	72	LR180-756	RH-126	183		
LR170-702B			VR-H2000-6H	72	LR180-756B			VR-H2000-44	69
LR170-704			VR-H2000-4H	70	LR180-769	RH-103	181	VR-H2000-45	69
LR170-706			VR-H2000-13	64	LR185-701	RH-75	189		
LR170-707B			VR-H2000-11	64	LR185-701C	RH-75	189		
LR170-709B	RH-69	188			LR185-702	RH-75	189		
LR170-710B			VR-H2000-20	66	LR190-432			VR-H2000-38	68
LR170-713			VR-H2000-4H	70	LR190-502B	RH-113	182		
LR170-715			VR-H2000-5H	71	LR190-502C	RH-113	182		
LR170-715B			VR-H2000-5H	71	LR190-504C			VR-H2000-39	69
LR170-716			VR-H2000-5H	71	LR190-505C			VR-H2000-39	69
LR170-716B	RH-39C	186	VR-H2000-5H	71	LR190-505E	RH-60	188	VR-H2000-39	69
LR170-717			VR-H2000-5H	71	LR190-511	RH-60	188	VR-H2000-39	69
LR170-721			VR-H2000-4H	70	LR190-511B	RH-60	188	VR-H2000-39	69
LR170-721B			VR-H2000-7H	72	LR190-512			VR-H2000-39	69
LR170-727			VR-H2000-5H	71	LR190-512B			VR-H2000-39	69
LR170-732B	RH-21	184	VR-H2000-15	64	LR190-512C	RH-61	188	VR-H2000-39	69
LR170-732C	RH-21	184	VR-H2000-15	64	LR190-515			VR-H2000-39	69
LR170-734	RH-22	184	VR-H2000-17	65	LR190-515B			VR-H2000-39	69
LR170-734B	RH-22	184	VR-H2000-17	65	LR190-701B	RH-43C	187		
LR170-738	RH-24	185	VR-H2000-14	64	LR190-702B	RH-43C	187		
LR170-738B	RH-26	185	VR-H2000-14	64	LR190-702C	RH-43C	187		
LR170-738C	RH-25	185	VR-H2000-16	65	LR190-703B	RH-43C	187		
LR170-739	RH-22	184	VR-H2000-17	65	LR190-704			VR-H2000-4H	70
LR170-739B			VR-H2000-18	65	LR190-704B	RH-43C	187	VR-H2000-7H	72
LR170-743			VR-H2000-42	69	LR190-706			VR-H2000-20	66
LR170-744			VR-H2000-16	65	LR190-707			VR-H2000-20	66
LR170-745	RH-30	186	VR-H2000-38	68	LR190-707B			VR-H2000-20	66
LR170-745,B			VR-H2000-42	69	LR190-708C	RH-43C	187		
LR170-745B			VR-H2000-38	68	LR190-709			VR-H2000-4H	70
LR170-746E			VR-H2000-42	69	LR190-709B			VR-H2000-7H	72
LR170-746F			VR-H2000-38	68	LR190-711	RH-43C	187	VR-H2000-7H	72
LR170-746G			VR-H2000-42	69	LR190-714			VR-H2000-20	66
LR170-746J			VR-H2000-38	68	LR190-715B			VR-H2000-16	65
LR170-748	RH-31	186			LR190-719			VR-H2000-18	65
LR170-748B	RH-31	186			LR190-724	RH-33	186	VR-H2000-27	66
LR170-749F			VR-H2000-62	71	LR190-725B			VR-H2000-38	68
LR170-750C			VR-H2000-38	68	VR-H2000-38			VR-H2000-42	69
LR170-750C,E			VR-H2000-42	69	LR190-725E			VR-H2000-38	68
LR170-750E			VR-H2000-38	68	LR190729			VR-H2000-43	69
LR170-752			VR-H2000-38	68	LR190-729	RH-31	186		
LR170-752,B			VR-H2000-42	69	LR190-730C			VR-H2000-62	71
LR170-752B			VR-H2000-38	68	LR190-732			VR-H2000-42	69
LR170-755	RH-66A	188	VR-H2000-48	70	LR190-734C			VR-H2000-62	71
LR170-757B	RV-H050	192			LR190-734E			VR-H2000-62	71
LR170-757BR	RV-H050	192			LR190737			VR-H2000-43	69
LR170-758			VR-H2000-51	70	LR190-737	RH-76	189		
LR170-765	RV-H050	192			LR190737E			VR-H2000-43	69
LR175-707			VR-H2000-11	64	LR190-737E	RH-76	189		
LR175-7070			VR-H2000-11	64	LR190-742	RH-83	189	VR-H2000-63	71
LR180-501	RH-58C	188	VR-H2000-65	72	LR190-744	RH-82	189	VR-H2000-62	71
LR180-501B	RH-58C	188	VR-H2000-65	72	LR190-744R			VR-H2000-62	71
LR180-501C			VR-H2000-65	72	LR190-761			VR-H2000-62	71
LR180-502			VR-H2000-65	72	LR190-772			VR-H2000-87	73
LR180-502R	RV-H013	191	VR-H2000-65	72	LR190-773			VR-H2000-87	73
LR180-503C			VR-H2000-65	72	LR195-701			VR-H2000-23	66
LR180-509C			VR-H2000-56	71	LR215-50			VR-H2000-2B	67
LR180-510			VR-H2000-56	71	LR220-23			VR-H2000-2B	67
LR180-512	RV-H078	192			LR220-24			VR-H2000-2B	67
LR180-7035			VR-H2000-16	65	LR225-402	RH-04C	181		
LR180-704			VR-H2000-4H	70	LR225-403	RH-04N	181	VR-H2000-3A	69

CROSS REFERENCE
Voltage Regulator

CROSS REFERENCE
Rectifier

CROSS REFERENCE
Diode Trio

ALTERNATOR NO.
Reg & Rec

CROSS REFERENCE LIST

OEM Alternator No. → Mobiletron No.

OEM Alternator No.	Rectifier No.	Page	Regulator No.	Page	OEM Alternator No.	Rectifier No.	Page	Regulator No.	Page
LR225-407	RH-50	187	VR-H2000-3A	69	LT135-54	RH-49	187		
LR225-408E			VR-H2000-3A	69	LT135-63B	RH-16C	184		
LR225-409B			VR-H2000-3A	69	LT135-68	RH-49	187		
LR225-410	RH-04N	181	VR-H2000-3A	69	LT135-73	RH-49	187		
LR225-412T			VR-H2000-3A	69	LT135-73B	RH-49	187		
LR225-413T			VR-H2000-3A	69	LT140-109B	RH-16C	184		
LR225-414T			VR-H2000-3A	69	LT140-109C	RH-16C	184		
LR225-415B			VR-H2000-3A	69	LT140-110B	RH-16C	184		
LR225-418B			VR-H2000-3A	69	LT150-03	RH-49	187		
LR225-65P	RH-04N	181	VR-H2000-3A	69	LT150-05	RH-49	187		
LR225-67P	RH-04N	181	VR-H2000-3A	69	LT150-10	RH-49	187		
LR225-68B	RH-03C	180	VR-H2000-3A	69	LT150-113	RH-11C	182		
LR225-80	RH-03	180			LT150-114	RH-12C	183		
LR225-80B			VR-H2000-3A	69	LT150-123	RH-11C	182		
LR225-84T			VR-H2000-2B	67	LT150-131	RH-09C	181		
LR225-85			VR-H2000-2B	67	LT150-144	RH-09C	181		
LR225-86B			VR-H2000-2B	67	LT150-21	RH-49	187		
LR225-89			VR-H2000-2B	67	LT150-22	RH-49	187		
LR235-401			VR-H2000-3A	69	LT150-23	RH-49	187		
LR235-402			VR-H2000-3A	69	LT150-26	RH-49	187		
LR235-403T			VR-H2000-3A	69	LT160-32	RH-49	187		
LR235-404T			VR-H2000-3A	69	LT210-01	RH-49	187		
LR235-405T			VR-H2000-3A	69	LT215-27	RH-49	187		
LR235-406			VR-H2000-3A	69	OK012-18300	RH-78	189	VR-H2000-52	70
LR235-58	RH-03C	180	VR-H2000-3A	69	OK241-18300	RH-78	189	VR-H2000-52	70
LR235-61C			VR-H2000-2B	67	HYUNDAI				
LR235-62	RH-10C	182	VR-H2000-2B	67	02131-9110	RK-04	193		
LR235-65			VR-H2000-2B	67	02131-9111	RK-04	193		
LR235-68			VR-H2000-2B	67	02131-9112	RV-K002	193		
LR235-69	RH-10C	182	VR-H2000-2B	67	02131-9113	RK-04	193		
LR235-70	RH-10C	182			13209	RP-56	193		
LR235-705	RH-65	188			23098	RK-04	193		
LR235-70B			VR-H2000-3A	69	37300-02500			VR-H2009-187	75
LR235-72B			VR-H2000-2B	67	37300-02503			VR-H2009-187	75
LR235-75C			VR-H2000-3A	69	37300-23720	RM-197	193		
LR235-76			VR-H2000-2B	67	37300-27010	RK-04	193		
LR235-78			VR-H2000-3A	69	37300-27011	RK-04	193		
LR235-80			VR-H2000-2B	67	37300-27012	RV-K002	193		
LR240-19C			VR-H2000-2B	67	37300-27013	RK-04	193		
LR240-20C			VR-H2000-2B	67	37300-27030	RV-K002	193		
LR240-21	RH-10C	182	VR-H2000-2B	67	37300-27031	RK-04	193		
LR240-22E			VR-H2000-2B	67	37300-2B300	RP-56	193		
LR240-25			VR-H2000-2B	67	37300-2B500	RP-56	193		
LR240-26			VR-H2000-2B	67	37300-2E200	RP-56	193		
LR240-29B			VR-H2000-2B	67	37300-2F100			VR-V018	75
LR240-31E			VR-H2000-2B	67	37300-41750			VR-H2009-192B	75
LR240-32			VR-H2000-2B	67	37300-41751			VR-H2009-192B	75
LR240-34			VR-H2000-3A	69	37300-45001			VR-MD14B	75
LR240-35			VR-H2000-3A	69	37300-48000			VR-V019B	75
LR240-401			VR-H2000-3A	69	AB160108			VR-H2009-187	75
LR240-402			VR-H2000-3A	69	AB240456			VR-MD14B	75
LR240-404C			VR-H2000-3A	69	AB250474			VR-MD13B	75
LR250-502C	RH-74A	189	VR-H2000-86B	73	OK87T-18300			VR-MD13B	75
LR250-507	RV-H003B	190	VR-H2000-86B	73	ISKRA				
LR250-507C	RH-74A	189	VR-H2000-86B	73	11201050			VR-IK029	76
LR250-508	RH-116	182	VR-H2000-80B	73	11201052			VR-IK029	76
LR250-511	RV-H083B	192	VR-H2000-94B	74	11201055			VR-IK029	76
LR250-517	RV-H057B	192	VR-H2000-76B	72	11201066			VR-IK029	76
LR250-707	RH-117	182	VR-H2000-80BA	73	11201069			VR-IK029	76
LR250-707C	RV-H053B	192			11201087			VR-IK029	76
LR260-18B			VR-H2000-3A	69	11201098			VR-IK029	76
LR260-20C			VR-H2000-3A	69	11201107			VR-IK029	76
LR270-02B			VR-H2000-3A	69	11201151			VR-IK029	76
LR270-03C			VR-H2000-3A	69	11201162			VR-IK029	76
LR270-05	RV-H005BA	191	VR-H2000-29B	67	11201186			VR-IK029	76
LR280-501	RH-111	182	VR-H2000-70B	72	11201201			VR-IK029	76
LR280-506	RV-H017B	191	VR-H2000-70B	72	11201273			VR-IK019	76
LR280-508	RV-H017B	191	VR-H2000-70B	72	11201360			VR-IK029	76
LR280-708B	RH-115	182			11201440	RK-02	194	VR-IK02	76
LRB303	RH-48	187			11201490	RK-02	194		
LRT150-430T			VR-H2000-30	68	11201498			VR-IK02	76
LT115-52	RH-49	187			11201522			VR-IK029	76
LT120-05	RH-49	187			11201534			VR-IK02	76
LT120-07	RH-49	187			11201555			VR-IK029	76
LT120-21	RH-49	187			11201557			VR-IK029	76
LT130-81	RH-49	187			11201574			VR-IK029	76
LT130-89	RH-49	187			11201586			VR-IK029	76
LT135-17	RH-49	187			11201597	RK-01	194		
LT135-22	RH-49	187			11201633			VR-IK029	76
LT135-24B	RH-49	187			11201635			VR-IK029	76
LT135-26	RH-49	187			11201666	RK-01	194	VR-IK01	76
LT135-30	RH-49	187			11201667	RK-01	194	VR-IK01	76
LT135-35	RH-49	187			11201675	RK-01	194		
LT135-35C	RH-49	187			11201699			VR-IK029	76
LT135-38C	RH-49	187			11201705			VR-IK029	76

CROSS REFERENCE LIST

OEM Alternator No. → Mobiletron No.

OEM Alternator No.	Rectifier No.	Page	Regulator No.	Page	OEM Alternator No.	Rectifier No.	Page	Regulator No.	Page
11201758	RK-01	194			A0014834LC	RC-18HD	195		
11201769			VR-IK02	76	A0014836AAH	RC-02HV	195		
2871A903	RK-06	194			A0014860JB	RC-02HV	195		
AAK1107			VR-IK029	76	A0014860JBH	RC-02HV	195		
AAK1109			VR-IK029	76	A0014884J	RC-02HV	195		
AAK1110			VR-IK029	76	A0014884JB	RC-02HV	195		
AAK1113			VR-IK029	76	A0014900JB	RC-02HV	195		
AAK1115			VR-IK029	76	A0014900JBS	RC-02HV	195		
AAK1125			VR-IK029	76	LUCAS				
AAK1131			VR-IK029	76	14050	RL-20H	198		
AAK1134			VR-IK029	76	23100-71J00	RL-10H	197	VR-LC111	80
AAK1153			VR-IK029	76	23544	RL-12H	197		
AAK1160			VR-IK029	76	23548	RL-12H	197		
AAK1167			VR-IK029	76	23554	RL-12H	197		
AAK1309			VR-IK029	76	23555	RL-12H	197		
AAK1314			VR-IK019	76	23562	RL-12H	197	VR-LC100	80
AAK1347			VR-IK029	76	23563	RL-12H	197	VR-LC100	80
AAK1352			VR-IK029	76	23565	RL-12H	197	VR-LC100	80
AAK1367			VR-IK029	76	23566	RL-12H	197	VR-LC100	80
AAK3520			VR-IK029	76	23568	RL-12H	197		
AAK3557			VR-IK029	76	23570	RL-12H	197		
AAK4127			VR-IK149	76	23572	RL-12H	197	VR-LC100	80
AAK4179			VR-IK029	76	23573	RL-12H	197		
AAK4507			VR-IK029	76	23574	RL-12H	197		
AAK4509			VR-IK029	76	23575	RL-12H	197		
AAK4531			VR-IK029	76	23576	RL-12H	197		
AAK4560			VR-IK029	76	23581	RL-12H	197	VR-LC100	80
AAK5102			VR-IK02	76	23582	RL-12H	197	VR-LC100	80
AAK5105			VR-IK02	76	23583	RL-12H	197		
AAK5108			VR-IK02	76	23584	RL-12H	197	VR-LC100	80
AAK5114	RK-01	194	VR-IK01	76	23585	RL-12H	197		
AAK5115	RK-01	194	VR-IK01	76	23589	RL-08HV	197	VR-LC100	80
AAK5118	RK-01	194			23590	RL-08HV	197	VR-LC100	80
AAK5132	RK-01	194			23591	RL-08HV	197		
AAK5136			VR-IK02	76	23592	RL-08HV	197	VR-LC100	80
AAN5806	RK-06	194			23593	RL-08HV	197	VR-LC100	80
AAN8167	RK-06	194			23595	RL-12H	197		
KIA					23597	RL-12H	197		
02121-8025			VR-K01	78	23598	RL-12H	197		
02121-8027			VR-K01	78	23599	RL-12H	197		
02121-8070			VR-K01	78	23600	RL-12H	197		
02121-8071			VR-K01	78	23602	RL-12H	197		
02121-8073			VR-K01	78	23602A			VR-LC100	80
02121-8074			VR-K01	78	23602B			VR-LC100	80
02121-9012			VR-K01	78	23603	RL-12H	197	VR-LC100	80
02121-9020			VR-K01	78	23605	RL-08HV	197		
02121-9021			VR-K01	78	23606	RL-08HV	197	VR-LC100	80
02121-9022			VR-K01	78	23615	RL-08HV	197	VR-LC100	80
02122-3030			VR-K01B	78	23616	RL-08HV	197		
02131-9020			VR-K02	78	23617	RL-08HV	197	VR-LC100	80
02131-9021			VR-K02	78	23618	RL-08HV	197		
02131-9111			VR-K05	78	23619	RL-08HV	197		
02131-9112			VR-K05	78	23620	RL-08HV	197	VR-LC100	80
02131-9113			VR-K05	78	23622	RL-08HV	197		
02131-9311			VR-K05	78	23623	RL-08HV	197		
23098			VR-K05	78	23624	RL-12H	197		
37300-12470			VR-K02	78	23625	RL-12H	197		
37300-27011			VR-K05	78	23626	RL-12H	197		
37300-27012			VR-K05	78	23627	RL-12H	197		
37300-27013			VR-K05	78	23629	RL-12H	197		
37300-27030			VR-K05	78	23630	RL-12H	197		
37300-27031			VR-K05	78	23631	RL-12H	197		
OK72A-18-300			VR-K02	78	23632	RL-08HV	197		
LADA					23634	RL-12H	197	VR-LC100	80
2105-370-1010			VR-LD150A	79	23635	RL-12H	197		
2205-370-1005			VR-LD150A	79	23636	RL-12H	197	VR-LC100	80
LEECE NEVILLE					23637	RL-12H	197	VR-LC100	80
4830LC	RC-02HV	195			23638	RL-12H	197	VR-LC100	80
4830CRM	RC-02HV	195			23639	RL-12H	197		
4836AAH	RC-02HV	195			23640	RL-12H	197	VR-LC100	80
4860J	RC-02HV	195			23641	RL-12H	197		
4860JB	RC-02HV	195			23642	RL-12H	197		
4884J	RC-02HV	195			23643	RL-12H	197		
4884JB	RC-02HV	195			23644	RL-12H	197	VR-LC100	80
4900J	RC-02HV	195			23645	RL-12H	197		
4900JB	RC-02HV	195			23646	RL-08HV	197	VR-LC100	80
4900JBS	RC-02HV	195			23647	RL-08HV	197	VR-LC100	80
8320	RC-02HV	195			23648	RL-08HV	197	VR-LC100	80
8345	RC-02HV	195			23649	RL-12H	197		
8348	RC-02HV	195			23650	RL-12H	197		
8667	RC-02HV	195			23652	RL-12H	197		
8674	RC-02HV	195			23653	RL-08HV	197		
90771	RC-02HV	195			23653A	RL-12H	197		
A001090771	RC-02HV	195			23654	RL-08HV	197		
A0014830LC	RC-02HV	195			23655	RL-12H	197		

CROSS REFERENCE
Voltage Regulator

CROSS REFERENCE
Rectifier

CROSS REFERENCE
Diode Trio

ALTERNATOR NO.
Reg & Rec

CROSS REFERENCE LIST

OEM Alternator No. → Mobiletron No.

OEM Alternator No.	Rectifier No.	Page	Regulator No.	Page	OEM Alternator No.	Rectifier No.	Page	Regulator No.	Page
23656	RL-12H	197			23767	RL-08HV	197		
23658	RL-12H	197			23768	RL-08HV	197		
23659	RL-08HV	197			23769	RL-08HV	197		
23660	RL-12H	197			23770	RL-08HV	197		
23661	RL-12H	197			23771	RL-08HV	197		
23662	RL-12H	197			23773	RL-08HV	197		
23663	RL-12H	197			23774	RL-08HV	197	VR-LC100	80
23664	RL-12H	197			23775	RL-08HV	197	VR-LC100	80
23665	RL-12H	197			23777	RL-08HV	197		
23666	RL-12H	197			23778	RL-12H	197		
23667	RL-12H	197			23779	RL-08HV	197		
23668	RL-12H	197			23780	RL-12H	197		
23673	RL-08HV	197			23781	RL-08HV	197		
23674			VR-LC100	80	23782	RL-08HV	197		
23675	RL-08HV	197	VR-LC100	80	23793	RL-13	197		
23676	RL-12H	197			23794	RL-08HV	197		
23677	RL-08HV	197			23795	RL-13H	197		
23678	RL-12H	197			23796	RL-13	197		
23679	RL-08HV	197			23797	RL-13H	197		
23682	RL-08HV	197	VR-LC100	80	23799	RL-08HV	197		
23685	RL-08HV	197	VR-LC100	80	23800	RL-08HV	197		
23691	RL-08HV	197			23801	RL-08HV	197	VR-LC100	80
23692	RL-08HV	197			23802	RL-08HV	197	VR-LC100	80
23694	RL-08HV	197			23804	RL-13	197		
23695	RL-08HV	197			23806	RL-20H	198		
23696	RL-12H	197			23806AB	RL-20H	198		
23699	RL-08HV	197			23807	RL-08HV	197		
23700	RL-08HV	197	VR-LC100	80	23808	RL-08HV	197	VR-LC100	80
23701	RL-08HV	197			23809	RL-08HV	197		
23702	RL-08HV	197			23810	RL-08HV	197		
23703	RL-08HV	197			23811	RL-08HV	197		
23704	RL-08HV	197			23813	RL-08HV	197		
23705	RL-08HV	197			23814	RL-08HV	197		
23706	RL-08HV	197			23816	RL-12H	197		
23707	RL-08HV	197			23818	RL-13	197		
23708	RL-08HV	197			23819	RL-08HV	197		
23709	RL-08HV	197	VR-LC100	80	23820	RL-12H	197		
23711	RL-08HV	197			23822	RL-12H	197		
23712	RL-08HV	197			23823	RL-12H	197		
23713	RL-08HV	197	VR-LC100	80	23824	RL-12H	197		
23714	RL-08HV	197			23825	RL-12H	197		
23715	RL-08HV	197	VR-LC100	80	23826	RL-12H	197		
23716	RL-08HV	197	VR-LC100	80	23827	RL-12H	197		
23717	RL-08HV	197			23828	RL-08HV	197		
23718	RL-08HV	197	VR-LC100	80	23830	RL-08HV	197		
23719	RL-08HV	197			23831	RL-08HV	197		
23721	RL-08HV	197			23832AB	RL-20H	198		
23723	RL-08HV	197			23833	RL-15	198		
23724	RL-08HV	197			23835	RL-14H	198		
23725	RL-08HV	197	VR-LC100	80	23837	RL-08HV	197		
23726	RL-08HV	197	VR-LC100	80	23838	RL-14H	198		
23727	RL-08HV	197			23839	RL-08HV	197		
23728	RL-08HV	197			23840	RL-08HV	197		
23729	RL-08HV	197	VR-LC100	80	23841	RL-08HV	197		
23730	RL-08HV	197	VR-LC100	80	23842	RL-08HV	197	VR-LC100	80
23731	RL-08HV	197			23843	RL-13H	197		
23734	RL-08HV	197	VR-LC100	80	23844	RL-13	197		
23735	RL-08HV	197			23845	RL-13H	197		
23736	RL-08HV	197			23846	RL-08HV	197		
23737	RL-08HV	197	VR-LC100	80	23847	RL-08HV	197		
23738	RL-08HV	197			23848	RL-08HV	197		
23739	RL-08HV	197			23849	RL-20H	198		
23740	RL-08HV	197			23849A	RL-20H	198		
23741	RL-12H	197			23850	RL-08HV	197	VR-LC100	80
23742	RL-12H	197			23851	RL-08HV	197	VR-LC100	80
23743	RL-08HV	197			23852	RL-08HV	197	VR-LC100	80
23745	RL-13H	197			23853	RL-08HV	197		
23746	RL-20H	198			23854	RL-08HV	197		
23746A	RL-20H	198			23855	RL-08HV	197		
23747	RL-13	197			23856	RL-08HV	197		
23748	RL-13H	197			23857	RL-08HV	197		
23750	RL-13	197			23859	RL-14H	198		
23751	RL-08HV	197			23860	RL-08HV	197		
23752	RL-08HV	197			23861	RL-15	198		
23753	RL-08HV	197			23862	RL-15H	198		
23754	RL-08HV	197			23863	RL-15	198		
23755	RL-08HV	197			23864	RL-14H	198		
23756AD	RL-20H	198			23865	RL-08HV	197		
23758	RL-08HV	197			23867	RL-15H	198		
23759	RL-08HV	197			23868	RL-14H	198		
23760	RL-08HV	197			23869	RL-14	198		
23761	RL-08HV	197			23871	RL-08HV	197		
23762	RL-08HV	197			23873	RL-08HV	197		
23765	RL-08HV	197	VR-LC100	80	23874	RL-12H	197		
23766	RL-08HV	197			23876	RL-14	198		

CROSS REFERENCE
Voltage Regulator

CROSS REFERENCE
Rectifier

CROSS REFERENCE
Diode Trio

ALTERNATOR NO.
Reg & Rec

CROSS REFERENCE LIST

OEM Alternator No. → Mobiletron No.

OEM Alternator No.	Rectifier No.	Page	Regulator No.	Page	OEM Alternator No.	Rectifier No.	Page	Regulator No.	Page
23877	RL-14H	198			24026	RL-02H	196		
23878	RL-08HV	197			24027	RL-02H	196		
23879	RL-08HV	197			24028	RL-02H	196		
23880	RL-08HV	197			24029	RL-14H	198	VR-LC200	81
23881	RL-14H	198			24030	RL-14H	198	VR-LC200	81
23882	RL-15	198			24031	RL-15H	198		
23883	RL-15H	198			24032	RL-14H	198		
23884	RL-15	198			24034	RL-04H	196		
23888	RL-08HV	197	VR-LC100	80	24035	RL-02H	196		
23889	RL-08HV	197			24036	RL-02H	196		
23890	RL-12H	197			24037	RL-02H	196	VR-LC200	81
23891	RL-08HV	197			24041	RL-03H	196		
23892A	RL-20H	198			24044	RL-14	198		
23893	RL-08HV	197			24045	RL-14H	198		
23896	RL-08HV	197			24046	RL-05H	196		
23903	RL-08HV	197			24047	RL-05H	196		
23904	RL-08HV	197			24048	RL-08HV	197		
23905	RL-08HV	197			24049			VR-LC201	81
23906	RL-08HV	197			24051	RL-02H	196		
23909	RL-08HV	197			24052	RL-02H	196		
23910	RL-08HV	197			24053	RL-04H	196		
23911	RL-08HV	197			24054	RL-04H	196		
23912	RL-08HV	197			24055	RL-05H	196		
23913	RL-08HV	197			24056	RL-17H	198	VR-LC200	81
23914	RL-08HV	197			24056AB	RL-17H	198		
23915	RL-08HV	197			24058	RL-02H	196		
23916	RL-08HV	197			24059	RL-02H	196		
23917	RL-08HV	197			24060	RL-03H	196		
23918	RL-08HV	197			24061	RL-02H	196	VR-LC200	81
23919	RL-08HV	197			24062	RL-02H	196		
23920	RL-08HV	197			24063	RL-02H	196		
23921	RL-08HV	197			24064	RL-02H	196		
23922	RL-08HV	197			24065	RL-02H	196		
23923	RL-08HV	197			24066	RL-02H	196		
23924	RL-08HV	197			24067	RL-04H	196		
23925	RL-08HV	197			24069	RL-04H	196		
23926	RL-08HV	197			24070	RL-04H	196		
23927	RL-08HV	197			24071	RL-04H	196		
23928	RL-08HV	197			24072	RL-04H	196		
23929	RL-08HV	197			24079	RL-04H	196		
23943	RL-08HV	197			24082	RL-02H	196		
23944	RL-08HV	197			24083	RL-02H	196		
23945	RL-08HV	197			24085	RL-02H	196		
23946	RL-08HV	197			24086	RL-04H	196		
23947	RL-08HV	197			24087	RL-02H	196	VR-LC200	81
23948	RL-08HV	197			24088	RL-04H	196		
23949	RL-08HV	197			24089	RL-04H	196		
23950	RL-08HV	197			24090	RL-04H	196		
23957	RL-14H	198			24091	RL-05H	196		
23958	RL-14	198			24092	RL-02H	196		
23961	RL-12H	197			24093	RL-05H	196		
23962	RL-08HV	197			24094	RL-02H	196		
23963	RL-08HV	197	VR-LC100	80	24095	RL-02H	196		
23967	RL-14H	198			24096	RL-04H	196	VR-LC200	81
23969	RL-05H	196			24098	RL-04H	196		
23970	RL-17H	198	VR-LC200	81	24099	RL-02H	196		
23970AB	RL-17H	198			24100	RL-05H	196		
23971	RL-17H	198	VR-LC200	81	24101	RL-17H	198	VR-LC200	81
23971A	RL-17H	198			24101AE	RL-17H	198		
23980	RL-16	198			24102	RL-17H	198	VR-LC200	81
23983	RL-02H	196			24102AE	RL-17H	198		
23984	RL-02H	196			24103	RL-08HV	197		
23985	RL-02H	196			24108	RL-08HV	197		
23986	RL-02H	196			24110A	RL-17H	198		
23989	RL-08HV	197			24112	RL-02H	196		
23990	RL-08HV	197			24114	RL-04H	196		
23991	RL-08HV	197			24115	RL-04H	196	VR-LC200	81
23993	RL-08HV	197			24116	RL-04H	196		
23994	RL-08HV	197			24117	RL-04H	196		
23996	RL-04H	196	VR-LC200	81	24118	RL-04H	196		
23997	RL-04H	196			24119	RL-04H	196		
23998	RL-04H	196			24123	RL-08HV	197		
23999	RL-04H	196			24125	RL-05H	196		
24010	RL-05H	196			24126	RL-05H	196		
24011	RL-05H	196	VR-LC200	81	24127	RL-05H	196		
24012	RL-08HV	197			24128	RL-04H	196		
24014	RL-08HV	197			24131	RL-02H	196		
24017	RL-14H	198			24132	RL-02H	196		
24018	RL-14	198			24134	RL-02H	196		
24019	RL-08HV	197			24135	RL-02H	196		
24020	RL-04H	196			24136	RL-04H	196		
24022	RL-08HV	197			24137	RL-04H	196		
24023	RL-02H	196			24139	RL-08HV	197		
24024	RL-02H	196			24142	RL-17H	198	VR-LC200	81
24025	RL-04H	196			24142AB	RL-17H	198		

CROSS REFERENCE
Voltage Regulator

CROSS REFERENCE
Rectifier

CROSS REFERENCE
Diode Trio

ALTERNATOR NO.
Reg & Rec

CROSS REFERENCE LIST

OEM Alternator No. → Mobiletron No.

	OEM Alternator No.	Rectifier No.	Page	Regulator No.	Page	OEM Alternator No.	Rectifier No.	Page	Regulator No.	Page
CROSS REFERENCE Voltage Regulator	24144	RL-02H	196			24236	RL-21H	198		
	24145	RL-01H	196		80	24237	RL-02H	196		
	24145AD				80	24238			VR-LC200	81
	24147	RL-02H	196			24240	RL-01H	196		
	24149	RL-04H	196			24241	RL-01H	196		
	24150AD	RL-17H	198			24242	RL-01H	196		
	24150EF	RL-17H	198			24245	RL-01H	196		
	24151	RL-04H	196			24246	RL-01H	196		
	24153	RL-04H	196			24246A			VR-LC113L	81
	24156	RL-01H	196	VR-LC111	80	24249	RL-01H	196		
CROSS REFERENCE Rectifier	24156AD				80	24250	RL-17H	198		
	24157	RL-01H	196	VR-LC111	80	24250A	RL-17H	198		
	24157AD				80	24255	RL-07H	196		
	24158	RL-01H	196	VR-LC111	80	24256	RL-01H	196		
	24161	RL-01H	196	VR-LC111	80	24256AC			VR-LC113L	81
	24164	RL-04H	196			24257	RL-21H	198		
	24165	RL-04H	196			24257A	RL-21H	198		
	24167	RL-03H	196			24258A			VR-LC113L	81
	24168	RL-03H	196			24261A	RL-21H	198		
	24169	RL-01H	196	VR-LC111	80	24262A			VR-LC113L	81
CROSS REFERENCE Diode Trio	24169AE				80	24264	RL-06H	196		
	24170	RL-02H	196			24271	RL-21H	198		
	24171	RL-03H	196			24271A	RL-21H	198		
	24173	RL-17H	198	VR-LC200	81	24273	RL-01H	196	VR-LC113L	81
	24173A	RL-17H	198			24273A			VR-LC113L	81
	24176A	RL-17H	198			24274	RL-01H	196		
	24177	RL-04H	196			24274A			VR-LC113L	81
	24178	RL-04H	196			24275A	RL-17H	198		
	24179	RL-02H	196			24276			VR-LC113L	81
	24180	RL-02H	196			24277			VR-LC113L	81
ALTERNATOR NO. Reg & Rec	24181	RL-02H	196			24278A			VR-LC113L	81
	24182	RL-02H	196			24279A			VR-LC113L	81
	24183	RL-02H	196			24286	RL-10H	197		
	24184	RL-02H	196			24287	RL-07H	196		
	24185	RL-02H	196			24295A			VR-LC113L	81
	24186	RL-17H	198			24299			VR-LC111B	80
	24186AB	RL-17H	198			24322A	RL-22H	198		
	24188	RL-06H	196			24356A	RL-22H	198		
	24188AC			VR-LC111	80	24406			VR-LC111B	80
	24189	RL-04H	196			26021117			VR-LC112	80
24190	RL-04H	196			26021326			VR-LC112	80	
24191	RL-04H	196			284315400101			VR-LC112	80	
24192	RL-04H	196			285001075			VR-LC112	80	
24198	RL-01H	196	VR-LC111	80	35213725	RL-23H	198			
24198AB			VR-LC111	80	35213730	RL-23H	198			
24199	RL-01H	196	VR-LC111	80	35213795			VR-LC115	81	
24199AB			VR-LC111	80	35213940			VR-LC115	81	
24200	RL-01H	196	VR-LC111	80	35213995			VR-LC115	81	
24200A			VR-LC111	80	35214100			VR-LC115	81	
24201A	RL-17H	198			4423302	RL-16	198			
24202			VR-LC111	80	54022159	RL-09H	197			
24203	RL-11H	197	VR-LC111	80	54022203	RL-22H	198			
24203A			VR-LC111	80	54022238	RL-22H	198			
24204	RL-04H	196			60921062	RL-03H	196			
24206			VR-LC111	80	A127			VR-LC111B	80	
24206AB	RL-09H	197	VR-LC111	80	E8NN-10316			VR-LC113L	81	
24207	RL-09H	197	VR-LC111	80	LRA129	RL-20H	198			
24207A	RL-09H	197	VR-LC111	80	LRA461	RL-09H	197			
24208	RL-01H	196	VR-LC111	80	LRA516	RL-21H	198			
24208AB			VR-LC111	80	LRA517	RL-09H	197			
24209	RL-01H	196			LRA518	RL-21H	198			
24209AB			VR-LC111	80	LRA521	RL-21H	198			
24210	RL-02H	196			LRA522			VR-LC113L	81	
24211	RL-02H	196			LRA530			VR-LC113L	81	
24213	RL-06H	196			LRA604	RL-09H	197			
24214	RL-11H	197			LRA775	RL-22H	198			
24215	RL-21H	198			NAB901			VR-LC111B	80	
24215A	RL-21H	198			NAB903			VR-LC111B	80	
24216	RL-09H	197			MAGNETI MARELLI					
24216A	RL-21H	198			102211-8140			VR-F154B	83	
24217	RL-09H	197			102211-8150			VR-F154B	83	
24217A	RL-09H	197			102211-8611			VR-F159	84	
24220	RL-09H	197			102211-8622	RI-35	201			
24220A	RL-09H	197			102211-8641	RI-34	201			
24221	RL-09H	197			102211-8650	RI-34	201			
24221A	RL-09H	197			102211-8660			VR-F159	84	
24223A	RL-22H	198			102211-8661	RI-34	201			
24224	RL-21H	198			12426			VR-F154B	83	
24228	RL-01H	196			12582	RI-35	201			
24229			VR-LC200	81	12814			VR-F154B	83	
24230	RL-06H	196			13256929	RI-35	201			
24231	RL-01H	196			14057			VR-F114A	82	
24232	RL-01H	196			14293			VR-F114A	82	
24235	RL-22H	198			14294			VR-F114A	82	
24235AD	RL-22H	198			14558			VR-F114A	82	

CROSS REFERENCE LIST

OEM Alternator No. → Mobiletron No.

OEM Alternator No.	Rectifier No.	Page	Regulator No.	Page	OEM Alternator No.	Rectifier No.	Page	Regulator No.	Page
20901			VR-F155	83	63305246			VR-F114A	82
21663			VR-F157	84	63305256			VR-F114A	82
22795			VR-F159	84	63305270			VR-F114A	82
23113			VR-F157	84	63305300	RI-01HA	199		
23169			VR-F157	84	63305310	RI-01HA	199	VR-F114A	82
23810			VR-F157	84	63305400	RI-01HA	199	VR-F114A	82
4181511	RI-04H	199			63305401	RI-01HA	199	VR-F114A	82
4378710	RI-04H	199			63305402	RI-01HA	199	VR-F114A	82
4379899	RI-01HA	199			63305403	RI-01HA	199	VR-F114A	82
4380114	RI-04H	199			63305404			VR-F114A	82
4393206	RI-01HA	199	VR-F114A	82	63305405			VR-F114A	82
4395131	RI-01HA	199	VR-F114A	82	63305406			VR-F114A	82
4408631	RI-04H	199			63305420	RI-01HA	199	VR-F114A	82
4419793	RI-01HA	199			63305423	RI-01HA	199	VR-F114A	82
4474524	RI-04H	199			63305425			VR-F114A	82
4474525	RI-04H	199			63305426			VR-F114A	82
4474557	RI-04H	199			63305430	RI-01HA	199	VR-F114A	82
4474904	RI-04H	199			63305431	RI-01HA	199	VR-F114A	82
4475035	RI-04H	199			63305432	RI-01HA	199		
46835095			VR-F159	84	63305440	RI-01HA	199	VR-F114A	82
4715786	RI-01HA	199	VR-F114B	82	63305442			VR-F114A	82
4738563	RI-01HA	199	VR-F114B	82	63305450			VR-F114A	82
4808510	RI-02HA	199			63305506	RI-01HA	199	VR-F114A	82
4808513	RI-02HA	199			63305526	RI-01HA	199	VR-F114A	82
4808517	RI-02HA	199			63305536	RI-01HA	199	VR-F114A	82
4808518	RI-02HA	199			63305556			VR-F114A	82
51784846			VR-F159	84	63305566			VR-F114A	82
54022437	RI-16H	200			63305601	RI-01HA	199		
54022443			VR-F154	83	63305621	RI-01HA	199	VR-F114A	82
54022459	RI-16H	200	VR-F121	83	63305690	RI-01HA	199		
54022469	RI-16H	200	VR-F121	83	63305700	RI-01HA	199	VR-F114A	82
54022470	RI-16H	200	VR-F121	83	63305701	RI-01HA	199	VR-F114A	82
54022510	RI-16H	200			63305702			VR-F114A	82
54022536	RI-16H	200			63305711			VR-F114A	82
54022591	RI-16H	200			63305712			VR-F114A	82
54022606	RI-16H	200	VR-F121	83	63305720	RI-01HA	199	VR-F114A	82
54022646	RI-16H	200			63305721	RI-01HA	199		
54022647	RI-16H	200			63305730			VR-F114A	82
54022651	RI-16H	200			63305800	RI-01HA	199	VR-F114A	82
54022656	RI-16H	200			63305801			VR-F114A	82
54022667			VR-F153MB	83	63305802			VR-F114A	82
5920974	RI-01HA	199	VR-F114A	82	63305820	RI-01HA	199	VR-F114A	82
5999868	RI-02HA	199			63305821			VR-F114A	82
5999869	RI-02HA	199			63305822			VR-F114A	82
62307526			VR-F114A	82	63305832			VR-F114A	82
63300515	RI-01HA	199			63305842			VR-F114A	82
63300905	RI-01HA	199	VR-F114A	82	63305862			VR-F114A	82
63300925	RI-01HA	199	VR-F114A	82	63305900			VR-F114A	82
63301000	RI-04H	199			63305920	RI-01HA	199		
63301020	RI-04H	199			63306000	RI-01HA	199	VR-F114B	82
63303000	RI-04H	199			63306050	RI-01HA	199		
63303001	RI-04H	199			63306060	RI-01HA	199		
63303030	RI-04H	199			63306070	RI-01HA	199		
63303200	RI-05H	199			63306079	RI-01HA	199		
63303202	RI-05H	199			63306089	RI-01HA	199		
63303203	RI-05H	199			63306300	RI-01HA	199	VR-F114B	82
63303213	RI-05H	199			63306350	RI-01HA	199		
63303220	RI-05H	199			63306360	RI-01HA	199		
63303222	RI-05H	199			63306370	RI-01HA	199		
63303223	RI-05H	199			63306379	RI-01HA	199		
63303240	RI-05H	199			63306389	RI-01HA	199		
63303280	RI-05H	199			63306500	RI-01HA	199		
63303282	RI-05H	199			63306520	RI-01HA	199		
63303290	RI-05H	199			63306700	RI-01HA	199	VR-F114A	82
63303300	RI-04H	199			63306701	RI-01HA	199	VR-F114A	82
63303311	RI-05H	199			63306720	RI-01HA	199		
63303380	RI-05H	199			63306721	RI-01HA	199	VR-F114A	82
63303391	RI-05H	199			63306730			VR-F114A	82
63304201	RI-05H	199			63307100			VR-F114A	82
63304520	RI-04H	199			63307101			VR-F114A	82
63305000	RI-01HA	199			63307103			VR-F114A	82
63305020	RI-01HA	199			63307105			VR-F114A	82
63305100	RI-01HA	199	VR-F114A	82	63307106			VR-F114A	82
63305101	RI-01HA	199	VR-F114A	82	63307108			VR-F114A	82
63305102			VR-F114A	82	63307120			VR-F114A	82
63305103			VR-F114A	82	63307123			VR-F114A	82
63305120	RI-01HA	199	VR-F114A	82	63307125			VR-F114A	82
63305122			VR-F114A	82	63307126			VR-F114A	82
63305123			VR-F114A	82	63307127			VR-F114A	82
63305130	RI-01HA	199	VR-F114A	82	63307128			VR-F114A	82
63305131	RI-01HA	199	VR-F114A	82	63307130			VR-F114A	82
63305150			VR-F114A	82	63307131			VR-F114A	82
63305206	RI-01HA	199	VR-F114A	82	63307150			VR-F114A	82
63305226	RI-01HA	199	VR-F114A	82	63307160			VR-F114A	82
63305236	RI-01HA	199	VR-F114A	82	63307206			VR-F114A	82

CROSS REFERENCE
Voltage Regulator

CROSS REFERENCE
Rectifier

CROSS REFERENCE
Diode Trio

ALTERNATOR NO.
Reg & Rec

CROSS REFERENCE LIST

OEM Alternator No. —> Mobiletron No.

OEM Alternator No.	Rectifier No.	Page	Regulator No.	Page	OEM Alternator No.	Rectifier No.	Page	Regulator No.	Page
63307207			VR-F114A	82	63320203			VR-F151A	83
63307208			VR-F114A	82	63320204	RI-21H	200		
63307218			VR-F114A	82	63320219			VR-F151A	83
63307227			VR-F114A	82	63320227	RI-21H	200	VR-F151A	83
63307236			VR-F114A	82	63320228	RI-15H	200	VR-F121	83
63307246			VR-F114A	82	63320238	RI-21H	200	VR-F151A	83
63307256			VR-F114A	82	63320253	RI-21H	200		
63307270			VR-F114A	82	63320255	RI-22H	200		
63307310			VR-F114A	82	63320256	RI-23HD	200		
63307400			VR-F114A	82	63320257	RI-21H	200		
63307401			VR-F114A	82	63320258	RI-21H	200		
63307403			VR-F114A	82	63320259	RI-21H	200		
63307405			VR-F114A	82	63320261	RI-21H	200		
63307406			VR-F114A	82	63320263	RI-21H	200		
63307407			VR-F114A	82	63320264	RI-21H	200		
63307408			VR-F114A	82	63320265	RI-21H	200		
63307410			VR-F114A	82	63320266	RI-22H	200		
63307420			VR-F114A	82	63320277	RI-23HD	200		
63307423			VR-F114A	82	63320279	RI-23H	200		
63307428			VR-F114A	82	63320280	RI-23HD	200		
63307429			VR-F114A	82	63320281	RI-18H	200		
63307430			VR-F114A	82	63320283	RI-23HD	200		
63307431			VR-F114A	82	63320286	RI-23H	200		
63307441			VR-F114A	82	63320287	RI-18H	200		
63307442			VR-F114A	82	63320288	RI-18H	200		
63307450			VR-F114A	82	63320289	RI-15H	200	VR-F121	83
63307452			VR-F114A	82	63320291	RI-18H	200		
63307460			VR-F114A	82	63320292	RI-23HD	200		
63307470			VR-F114A	82	63320296	RI-23H	200		
63307490			VR-F114A	82	63320298	RI-23HD	200		
63307503			VR-F114A	82	63320303	RI-23H	200		
63307506			VR-F114A	82	63320304	RI-23HD	200		
63307508			VR-F114A	82	63320312	RI-16H	200	VR-F121	83
63307509			VR-F114A	82	63320313	RI-16H	200	VR-F121	83
63307518			VR-F114A	82	63320314	RI-16H	200	VR-F121	83
63307523			VR-F114A	82	63320315	RI-15H	200	VR-F121	83
63307526			VR-F114A	82	63320332	RI-23HD	200		
63307536			VR-F114A	82	63320333	RI-23H	200		
63307556			VR-F114A	82	63320334	RI-24H	201		
63307566			VR-F114A	82	63320335	RI-24H	201		
63307602			VR-F114A	82	63320336	RI-24H	201		
63307604			VR-F114A	82	63320338	RI-23HD	200		
63307622			VR-F114A	82	63320339	RI-23H	200		
63307634			VR-F114A	82	63320340	RI-23HD	200		
63307801			VR-F114A	82	63320341	RI-23H	200		
63307802			VR-F114A	82	63320348	RI-23HD	200		
63307804			VR-F114A	82	63320500	RI-21H	200		
63307821			VR-F114A	82	63320502	RI-35	201		
63307822			VR-F114A	82	63320503	RI-21H	200		
63307824			VR-F114A	82	63320504	RI-21H	200		
63307841			VR-F114A	82	63320505	RI-21H	200		
63307842			VR-F114A	82	63320506	RI-21H	200		
63307851			VR-F114A	82	63320507	RI-22H	200		
63307862			VR-F114A	82	63320508	RI-21H	200		
63307872			VR-F114A	82	63320509	RI-22H	200		
63308701			VR-F114A	82	63320510	RI-35	201		
63308721			VR-F114A	82	63320511	RI-21H	200		
63308731			VR-F114A	82	63320512	RI-21H	200		
63320001	RI-02HA	199			63320513	RI-22H	200		
63320002	RI-02HA	199			63320515	RI-21H	200		
63320003	RI-02HA	199			63320519	RI-21H	200		
63320004	RI-02HA	199			63320520	RI-21H	200		
63320005	RI-02HA	199			63320521	RI-22H	200		
63320006	RI-02HA	199			63320522	RI-21H	200		
63320007	RI-02HA	199			63320530	RI-21H	200		
63320008	RI-02HA	199			63320531	RI-21H	200		
63320010	RI-02HA	199			63320535			VR-F160	84
63320013	RI-02HA	199			63320545			VR-F160	84
63320015	RI-02HA	199			63321000	RI-02HA	199		
63320016	RI-02HA	199			63321001	RI-02HA	199		
63320017	RI-02HA	199			63321002	RI-02HA	199		
63320018	RI-02HA	199			63321003	RI-02HA	199		
63320025	RI-02HA	199	VR-F119B	83	63321004	RI-02HA	199		
63320026	RI-02HA	199			63321005	RI-02HA	199		
63320027			VR-F118	82	63321007	RI-02HA	199		
63320028	RI-02HA	199			63321009	RI-02HA	199		
63320039			VR-F118	82	63321010	RI-02HA	199		
63320041	RI-13H	200	VR-F118	82	63321011	RI-02HA	199		
63320042	RI-11H	199			63321013	RI-02HA	199		
63320046	RI-11H	199			63321019	RI-02HA	199		
63320052			VR-F119B	83	63321020	RI-02HA	199		
63320057			VR-F119B	83	63321021	RI-02HA	199		
633-200SERIES			VR-F119	82	63321022	RI-02HA	199		
63320118			VR-F119B	83	63321023	RI-02HA	199		
63320200			VR-F151A	83	63321025	RI-02HA	199		

CROSS REFERENCE
Voltage Regulator

CROSS REFERENCE
Rectifier

CROSS REFERENCE
Diode Trio

ALTERNATOR NO.
Reg & Rec

CROSS REFERENCE LIST

OEM Alternator No. → Mobiletron No.

OEM Alternator No.	Rectifier No.	Page	Regulator No.	Page	OEM Alternator No.	Rectifier No.	Page	Regulator No.	Page
63321036	RI-02HA	199			63321616	RI-21H	200		
63321037	RI-02HA	199			63321617	RI-35	201		
63321042	RI-02HA	199			63321618	RI-14H	200		
63321046			VR-F119B	83	63321620	RI-21H	200		
63321047			VR-F119B	83	63321625	RI-21H	200		
63321048			VR-F119B	83	63321626	RI-21H	200		
63321049			VR-F119B	83	63321629	RI-14H	200		
63321050			VR-F119B	83	63321631	RI-14H	200		
63321052			VR-F119B	83	63321632	RI-21H	200		
63321055			VR-F119B	83	63321640	RI-21H	200		
63321056	RI-02HA	199			63321641			VR-F155	83
63321057			VR-F118	82	63321658			VR-F160	84
63321063			VR-F119B	83	63321660	RI-21H	200		
63321064	RI-02HA	199			63321661	RI-21H	200		
63321071	RI-02HA	199			63321671			VR-F155	83
63321081			VR-F118	82	63321678			VR-F156	84
63321083	RI-11H	199	VR-F118	82	63321679	RI-32M	201	VR-F156	84
63321084	RI-11H	199			63321692	RI-31H	201		
63321096	RI-11H	199			63321693	RI-31H	201		
633-210SERIES			VR-F119	82	63321697	RI-32M	201		
63321102			VR-F119B	83	63321702			VR-F160	84
63321104			VR-F119B	83	63321704	RI-31H	201		
63321110			VR-F119B	83	63321705	RI-31H	201		
63321200			VR-F151A	83	63321712			VR-F158	84
63321204	RI-14H	200	VR-F151A	83	63321713			VR-F158	84
63321205	RI-21H	200			63321718			VR-F158	84
63321206	RI-21H	200			63321733			VR-F157	84
63321207	RI-21H	200			63321734			VR-F157	84
63321208	RI-21H	200			63321740			VR-F157	84
63321209	RI-21H	200			63321741			VR-F157	84
63321210	RI-21H	200			63321744	RI-35	201		
63321211	RI-21H	200			63321746			VR-F156	84
63321213	RI-21H	200			63321829			VR-F157	84
63321215	RI-21H	200			63322101	RI-12H	200		
63321233	RI-14H	200	VR-F151A	83	63324320	RI-16H	200		
63321234	RI-14H	200	VR-F151A	83	63324380	RI-16H	200		
63321235	RI-21H	200	VR-F151A	83	63324390	RI-16H	200		
6332124			VR-F151A	83	63341238	RI-25	201		
63321240	RI-19H	200	VR-F153A	83	63341239	RI-25	201		
63321243	RI-15H	200	VR-F121	83	63341240			VR-F153A	83
63321252	RI-14H	200	VR-F151A	83	63341261			VR-F150A	83
63321253			VR-F121	83	63341321	RI-18H	200	VR-F153A	83
63321258			VR-F121	83	63341333	RI-18H	200	VR-F153A	83
63321261			VR-F150A	83	63341351			VR-F153A	83
63321270	RI-21H	200			63341352	RI-18H	200	VR-F153A	83
63321275	RI-21H	200			63341353	RI-17H	200	VR-F153A	83
63321276	RI-21H	200			63341354	RI-17H	200	VR-F153A	83
63321277	RI-21H	200			63341641			VR-F155	83
63321278	RI-21H	200			63341658			VR-F160	84
63321280	RI-21H	200			63341666	RI-25	201		
63321281	RI-21H	200			63341671			VR-F155	83
63321282	RI-21H	200			63341679	RI-32M	201	VR-F156	84
63321283	RI-21H	200			63341697	RI-32M	201		
63321287	RI-35	201			63341702			VR-F160	84
63321292	RI-35	201			63341704	RI-31H	201		
63321300	RI-21H	200			63341705	RI-31H	201		
63321311	RI-21H	200			63377465			VR-F154B	83
63321321	RI-18H	200	VR-F153A	83	63377466			VR-F154B	83
63321330	RI-35	201			63441243	RI-15H	200		
63321333			VR-F153A	83	63620039	RI-12H	200		
63321348	RI-31H	201			7541401	RI-02HA	199		
63321351	RI-18H	200	VR-F153A	83	7541822	RI-02HA	199		
63321352	RI-18H	200	VR-F153A	83	7541823	RI-02HA	199		
63321353	RI-17H	200	VR-F153A	83	7542145	RI-02HA	199		
63321354	RI-17H	200	VR-F153A	83	7546342	RI-02HA	199		
63321356	RI-31H	201			7546343	RI-02HA	199		
63321358	RI-16H	200			7546660	RI-02HA	199		
63321361	RI-21H	200			7546686	RI-02HA	199		
63321362	RI-21H	200			7546759	RI-02HA	199		
63321367	RI-21H	200			7547660	RI-02HA	199		
63321396	RI-21H	200			7547686	RI-02HA	199		
63321491			VR-F158	84	7548004	RI-02HA	199		
63321494			VR-F158	84	7552284	RI-02HA	199		
63321507			VR-F158	84	7552382	RI-02HA	199		
63321600	RI-21H	200			7552458	RI-02HA	199		
63321601	RI-35	201			7552675	RI-02HA	199		
63321602	RI-21H	200			7553788	RI-02HA	199		
63321603	RI-21H	200			7553853	RI-02HA	199		
63321604	RI-35	201			7554830	RI-02HA	199		
63321605	RI-35	201			7554832	RI-02HA	199		
63321606	RI-35	201			7554833	RI-02HA	199		
63321607	RI-35	201			79014078	RI-04H	199		
63321608	RI-35	201			9-120-330-268	RI-04H	199		
63321612	RI-14H	200			9-120-330-286	RI-04H	199		
63321615	RI-35	201			9-120-330-288	RI-05H	199		

CROSS REFERENCE
Voltage Regulator

CROSS REFERENCE
Rectifier

CROSS REFERENCE
Diode Trio

ALTERNATOR NO.
Reg & Rec

CROSS REFERENCE LIST

OEM Alternator No. → Mobiletron No.

OEM Alternator No.	Rectifier No.	Page	Regulator No.	Page	OEM Alternator No.	Rectifier No.	Page	Regulator No.	Page
9-120-330-289	RI-05H	199			11053			VR-H2009-70A	105
9-120-331-853	RI-06H	199			11055			VR-H2009-70A	105
9-120-331-854	RI-06H	199			11097			VR-H2009-169	94
9-120-331-863	RI-06H	199			11118			VR-H2009-70A	105
9-120-331-872	RI-06H	199			111373			VR-H2009-57	103
98AB-10300GC	RI-32H	201			11168			VR-H2009-114	89
98AB10300GD			VR-F156	84	11169			VR-H2009-114	89
98AB-10300GD	RI-32M	201			11170			VR-H2009-70A	105
98AB-10300GE	RI-32H	201			11173	RM-208	212	VR-H2009-98	109
98AB-10300GF	RI-32M	201			11175			VR-H2009-113	89
98AB-10300GG	RI-32H	201			11176	RM-181	210	VR-H2009-113	89
A1151	RI-25	201	VR-F156	84	11224			VR-H2009-177	95
A115IM			VR-F157	84	11228	RM-199	211		
A124N	RI-04H	199			11271			VR-H2009-140	92
A1271			VR-F151A	83	11272	RM-178HD	210	VR-H2009-140	92
A1271R			VR-F151A	83	11315	RM-194	211	VR-H2009-130	91
A127I			VR-F121T	83	11329			VR-H2009-126	91
A127IM			VR-F158	84	11330			VR-H2009-114	89
A12M	RI-04H	199			11340	RM-199	211		
AA1151			VR-F151A	83	11341	RM-179	210		
AA125-14V-55A-V1			VR-F114A	82	11343	RM-180HV	210	VR-H2009-148	93
AA125-14V-55A-V3			VR-F114A	82	11344	RM-180HV	210	VR-H2009-148	93
AA125-14V-55A-V4			VR-F114A	82	11376			VR-H2009-173	95
AA125-14V-55A-V5			VR-F114A	82	11377			VR-H2009-159	93
AA125-28-30A			VR-F114B	82	11398			VR-H2009-114	89
ALB40N88	RI-05H	199			11410	RM-175	210	VR-H2009-139	92
ALB40N89	RI-05H	199			11411			VR-H2009-140	92
ALP12NR19	RI-06H	199			11413			VR-H2009-122	90
ALS12N53	RI-06H	199			11414			VR-H2009-130	91
ALS12N54	RI-06H	199			11418			VR-H2009-172	95
ALS12N63	RI-06H	199			11420	RM-201	212	VR-H2009-172	95
ALS12N64	RI-06H	199			11421	RM-193HD	211	VR-H2009-172	95
ALS12N72	RI-06H	199			11440	RM-203	212		
ALT12N38	RI-06H	199			11537	RM-224	213	VR-H2009-171	95
AMR2938			VR-F153A	83	11542			VR-H2009-140	92
RTM200.13			VR-F159	84	11578			VR-H2009-126	91
MAGNETON-PAL					11579	RM-221	213	VR-H2009-210	98
443113516630			VR-MP134	85	11684			VR-H2009-140	92
443113516631			VR-MP134	85	11873	RM-245HD	214	VR-H2009-218	99
443113516632			VR-MP134	85	12233			VR-H2009-161	94
443113516650			VR-MP134	85	12563			VR-H2009-205B	98
443113516653			VR-MP134	85	12566	RM-240	214	VR-H2009-120	90
MANDO					12604	RM-157H	209		
13702	RM-198	203			12628	RM-165H	209		
22862			VR-MD12	86	12644			VR-H2009-203	98
37300-22200	RM-117	203	VR-H2009-86	86	12647			VR-H2009-129	91
37300-22600			VR-MD06	86	12728			VR-H2009-64A	104
37300-38310	RM-133	203	VR-H2009-106	86	12734			VR-H2009-64A	104
37300-39600			VR-MD08	86	12745			VR-H2009-153	93
37300-42204			VR-MD01	86	12878			VR-H2009-140	92
37300-42353			VR-MD12	86	12918			VR-H2009-172	95
37300-42355			VR-MD12	86	12976			VR-H2009-172	95
37300-42451			VR-MD12	86	13479			VR-H2009-115	89
A00B0431	RM-123	203			13506528	RM-246	214	VR-H2009-220	99
AB112112	RM-144	203			13649			VR-H2009-152	93
AB112145	RM-144	203	VR-MD08	86	13718	RM-110HV	206		
AB170094	RM-118	203	VR-MD07	86	13723			VR-H2009-118	90
AB180128	RM-132	203	VR-MD06	86	13750			VR-H2009-70A	105
AB190058	RM-198	203			13751			VR-H2009-70A	105
AB195126	RM-133	203	VR-H2009-106	86	13752			VR-H2009-115	89
AC15515	RM-123	203			13787			VR-H2009-70A	105
AC155515	RM-123	203			13840			VR-H2009-70A	105
AC155603	RM-123	203			13886			VR-H2009-70A	105
AC165610	RM-123	203			13889	RM-185	211		
AF111364			VR-MD12	86	13898			VR-H2009-70A	105
AR150A			VR-MD04	86	13929			VR-H2009-70A	105
AR150AA			VR-MD04	86	13966			VR-H2009-94	108
AR150AC			VR-MD04	86	1480-18-300	RM-69	220	VR-H2009	87
AR150BA			VR-MD03	86	1516176	RM-210HV	212	VR-H2009-151B	93
AR150CA			VR-MD03	86	1525447	RM-210HV	212	VR-H2009-151B	93
OK2A2-18300	RM-118	203			1536236			VR-H2009-197B	97
TA000A48401			VR-MD06L	86	1777299			VR-H2009-132B	91
TA000A48402			VR-MD06L	86	1777301			VR-H2009-197B	97
mitsubishi					1777466			VR-H2009-197B	97
02131-9021			VR-H2009-4A	102	20059			VR-H2009-207B	98
04314-P08-014			VR-H2009-40	101	20081	RM-238	214		
04314-P0G-A02			VR-H2009-88	107	20288	RM-237	214	VR-H2009-209	98
04801490AA	RM-203	212			20389	RM-239	214		
11004			VR-H2009-99	109	20629			VR-H2009-70A	105
11006	RM-192	211	VR-H2009-114	89	20778	RM-200	212		
11007			VR-H2009-114	89	21208			VR-H2009-83	107
11024	RM-184	211	VR-H2009-107	88	22446			VR-H2009-59	103
11026	RM-189H	211			22665			VR-H2009-115	89
11028			VR-H2009-70A	105	22684			VR-H2009-59	103
11029	RM-182	211	VR-H2009-159	93	22751			VR-H2009-6A	105

CROSS REFERENCE
Voltage Regulator

CROSS REFERENCE
Rectifier

CROSS REFERENCE
Diode Trio

ALTERNATOR NO.
Reg & Rec

CROSS REFERENCE LIST

OEM Alternator No. → Mobiletron No.

OEM Alternator No.	Rectifier No.	Page	Regulator No.	Page	OEM Alternator No.	Rectifier No.	Page	Regulator No.	Page
22924			VR-H2009-70A	105	23100-EM01B	RM-180HV	210	VR-H2009-148	93
23028			VR-H2009-115	89	23100-EM01BR	RM-180HV	210	VR-H2009-148	93
23100-01B10			VR-H2009-3	100	23100-FU410			VR-H2009-120	90
23100-01B15			VR-H2009-3	100	23100-G3710			VR-H2009-51	103
23100-01F10			VR-H2009-3	100	23100-G3711			VR-H2009-51	103
23100-01W10	RM-60	218			23100-G3715			VR-H2009-51	103
23100-02E10			VR-H2009-6H	105	23100-G3716			VR-H2009-51	103
23100-02E11			VR-H2009-6H	105	23100-H7711	RM-68	219	VR-H2009-3	100
23100-02E15			VR-H2009-6H	105	23100-H9011	RM-68	219		
23100-02E16			VR-H2009-6H	105	23100-JA11A	RM-179	210	VR-H2009-130	91
23100-04D00	RM-73	220			23100-JA11AR	RM-179	210	VR-H2009-130	91
23100-04D01	RM-73	220			23100-JA11B	RM-179	210	VR-H2009-130	91
23100-04F01	RM-06	204			23100-JD200	RM-180HV	210	VR-H2009-148	93
23100-04F10	RM-06	204			23100-JD71A	RM-213	212		
23100-04F11	RM-06	204			23100-JK01A	RM-199	211		
23100-04M10			VR-H2009-3	100	23100-JN81A	RM-180HV	210	VR-H2009-148	93
23100-05B10	RM-85	221			23100-M6610	RM-85	221		
23100-05E17	RM-76	220			23100-N9511	RM-68	219		
23100-05E18	RM-76	220	VR-H2009-56	103	23100-N9512	RM-85	221		
23100-05E70	RM-76	220	VR-H2009-56	103	23100-OB00			VR-H2009-38	101
23100-05P11	RM-74	220	VR-H2009-6H	105	23100-OP515			VR-H2009-45	101
23100-05P12			VR-H2009-6H	105	23100-P2518	RM-68	219		
23100-06T10	RM-60	218			23100-P3016	RM-75	220		
23100-07F11	RM-12	206			23100-P3017			VR-H2009-3	100
23100-0B000	RM-48	217			23100-Q0811	RM-75	220		
23100-0H611	RM-24	214			23100-Q4511	RM-68	219		
23100-0M010			VR-H2009-118	90	23100-Q4611	RM-75	220		
23100-0Y710			VR-H2009-115	89	23100-Q7111	RM-68	219		
23100-10B10	RM-85	221	VR-H2009-3	100	23100-R9011			VR-H2009-3	100
23100-12C10	RM-12	206	VR-H2009-15	93	23100-W1502	RM-68	219		
23100-12C11	RM-12	206	VR-H2009-8H	107	23100-W1615	RM-75	220		
23100-14P11			VR-H2009-6H	105	23100-W1710			VR-H2009-51	103
23100-14P12			VR-H2009-6H	105	23100-W1714			VR-H2009-51	103
23100-15P11	RM-06	204	VR-H2009-6H	105	23100-W1715			VR-H2009-51	103
23100-15P12			VR-H2009-6H	105	23100-W1719			VR-H2009-51	103
23100-15P13			VR-H2009-6H	105	23100W28100	RM-68	219		
23100-15P90			VR-H2009-6H	105	23100-W5811			VR-H2009-3	100
23100-15P91	RM-06	204	VR-H2009-6H	105	23100-W5816	RM-75	220		
23100-17S10			VR-H2009-51	103	23100-W7015	RM-68	219		
23100-17S15			VR-H2009-51	103	23100-W7510	RM-75	220		
23100-1AA1A	RM-179	210	VR-H2009-130	91	23100-ZW40B			VR-H2009-122	90
23100-1AA1B	RM-207	212			23160-07F11			VR-H2009-8H	107
23100-1BN1A			VR-H2009-176	95	23300-D4110			VR-H2009-8H	107
23100-1FC1A			VR-H2009-130	91	23311	RM-155HV	209	VR-H2009-170	94
23100-1HH1A	RM-238	214			23700-AA060	RM-33	215		
23100-1KA1A			VR-H2009-130	91	23700-AA061	RM-42	216		
23100-1KL1A			VR-H2009-130	91	23700-AA180			VR-H2009-65	104
23100-26E10	RM-09HV	205	VR-H2009-8H	107	23700-AA280			VR-H2009-115	89
23100-26E11	RM-09HV	205	VR-H2009-8H	107	23700-AA290	RM-130	207		
23100-26E60	RM-09HV	205			23700-AA370	RM-185	211		
23100-26E61	RM-09HV	205			23700-AA37A	RM-185	211		
23100-27G10	RM-85	221			23700-AA380			VR-H2009-109	88
23100-2DL1B			VR-H2009-130	91	23700-AA420			VR-H2009-109	88
23100-2Y005			VR-H2009-121	90	23700-AA430			VR-H2009-107	88
23100-31P10			VR-H2009-15	93	23700-AA55A	RM-184	211	VR-H2009-107	88
23100-35F10			VR-H2009-15	93	23700-AA620			VR-H2009-180	96
23100-3FY1A	RM-199	211			23700-AA700	RM-221	213		
23100-42L11			VR-H2009-6H	105	23700-KA190	RM-03HV	204		
23100-42L71			VR-H2009-6H	105	23700-KA240	RM-03HV	204	VR-H2009-34	100
23100-4M610			VR-H2009-118	90	23700-KA360	RM-03HV	204	VR-H2009-34	100
23100-4M611			VR-H2009-118	90	23849	RM-176	210		
23100-50K10			VR-H2009-201	98	23856	RM-159	209		
23100-51S10			VR-H2009-27	100	23857			VR-H2009-196	97
23100-53A10	RM-05HV	204	VR-H2009-23	99	23917			VR-H2009-122	90
23100-53A11	RM-05HV	204	VR-H2009-23	99	23918	RM-168	209	VR-H2009-130	91
23100-65E10			VR-H2009-15	93	24468-28100	RM-75	220		
23100-65F17			VR-H2009-115	89	2S6T-10300DB	RM-187H	211	VR-H2009-102	87
23100-6T012			VR-H2009-118	90	2S6U-10300GB	RM-187H	211	VR-H2009-102	87
23100-77A10	RM-14	208			30020754	RM-145	208	VR-H2009-90	108
23100-7B000	RM-134	207	VR-H2009-108	88	3066857101	RM-60	218		
23100-AM610			VR-H2009-99	109	31100-5A2-A02			VR-H2009-208	98
23100-B9810	RM-60	218	VR-H2009-3	100	31100-5R0-004			VR-H2009-204	98
23100-D0111	RM-68	219			31100-5R7-A01			VR-H2009-204	98
23100-D0211	RM-75	220	VR-H2009-3	100	31100-5R7-A02			VR-H2009-204	98
23100-D4110	RM-09HV	205			31100-AHG-A03			VR-H2009-20	98
23100-D4410	RM-09HV	205	VR-H2009-8H	107	31100-O08-014			VR-H2009-40	101
23100-D4415	RM-09HV	205	VR-H2009-8H	107	31100-P00-014	RM-27	214		
23100-DC000	RM-159	209			31100-P0G-A03			VR-H2009-88	107
23100-EB310			VR-H2009-145	92	31100-P2EA02	RM-129	207		
23100-EB315	RM-168	209	VR-H2009-130	91	31100-PE0-906			VR-H2009-32	100
23100-EB31A			VR-H2009-122	90	31100-PE0-9270			VR-H2009-32	100
23100-EB71A	RM-161HV	209	VR-H2009-123	91	31100-PEJ004	RM-129	207		
23100-ED01A			VR-H2009-130	91	31100-PEJ-004			VR-H2009-152	93
23100-EG010	RM-194	211	VR-H2009-130	91	31100-PLM-A01	RM-136	208		
23100-EM01A	RM-180HV	210	VR-H2009-148	93	31100-PLM-A012	RM-136	208		

CROSS REFERENCE
Voltage Regulator

CROSS REFERENCE
Rectifier

CROSS REFERENCE
Diode Trio

ALTERNATOR NO.
Reg & Rec

CROSS REFERENCE LIST

OEM Alternator No. → Mobiletron No.

	OEM Alternator No.	Rectifier No.	Page	Regulator No.	Page	OEM Alternator No.	Rectifier No.	Page	Regulator No.	Page
CROSS REFERENCE Voltage Regulator	31100-PLM-C012	RM-136	208			6E5T-10300BD	RM-208	212		
	31100-PND-004	RM-154HV	209	VR-H2009-94	108	6E5Z-10346BA	RM-208	212		
	31100-R1A-A01	RM-224	213	VR-H2009-171	95	7E5T-10300AA			VR-H2009-98	109
	31100-RB0-004	RM-175	210	VR-H2009-139	92	7E5T-10300BB	RM-208	212		
	31100-RB0-0041			VR-H2009-139	92	8173-18-300			VR-H2009	87
	31100-RB0A-0243			VR-H2009-139	92	8173-18-300B	RM-69	220	VR-H2009	87
	31100-REA-Z01			VR-H2009-144	92	8200404465			VR-H2009-164	94
	31100-RNA-A01	RM-181	210			8200654785	RM-200	212	VR-H2009-164	94
	31100-RNE-A01			VR-H2009-113	89	8200654786			VR-H2009-164	94
	31100-RNE-A010M2			VR-H2009-113	89	8200654789			VR-H2009-195	97
CROSS REFERENCE Rectifier	31100-RSH-004	RM-158H	209	VR-H2009-119	90	8200960536			VR-H2009-164	94
	31150-P2E-A01			VR-H2009-71	105	8200960538			VR-H2009-195	97
	31400-50G10			VR-H2009-44	101	8341-18-300	RM-68	219	VR-H2009	87
	31400-60A20	RM-22	213	VR-H2009-14N	93	8356-18-300	RM-74	220	VR-H2009	87
	31400-60ACI			VR-H2009-44	101	8492-18-300	RM-68	219		
	31400-61J00			VR-H2009-147	92	8574-18-300	RM-74	220	VR-H2009-3	100
	31400-63BD2			VR-H2009-44	101	859918300	RM-71	220		
	31400-65D00			VR-H2009-90	108	8599-18-300			VR-H2009-53	103
	31400-65D01			VR-H2009-90	108	86651830	RM-12	206		
	31400-65J20			VR-H2009-177	95	8A4T-10300AC			VR-H2009-140	92
CROSS REFERENCE Diode Trio	31400-66D00	RM-129A	207			8A4Z-10346A			VR-H2009-140	92
	31400-66D01	RM-129A	207			8S4T-10300AA	RM-178HD	210	VR-H2009-140	92
	31400-73G11			VR-H2009-111	89	8S4Z-10346A	RM-178HD	210	VR-H2009-140	92
	34468-16100	RM-60	218			92058857			VR-H2009-115	89
	3446826100	RM-60	218			92191127			VR-H2009-172	95
	3446828100	RM-60	218			92230902			VR-H2009-188	96
	37011-00J11-A1			VR-H2009-157	93	96058486	RM-22	213		
	37300-02503	RM-124	206			9638275880			VR-H2009-105	88
	37300-21013			VR-H2009-4H	102	9640088080	RM-155HV	209	VR-H2009-105SE	88
	37300-21320			VR-H2009-4H	102	9642124980			VR-H2009-170	94
ALTERNATOR NO. Reg & Rec	37300-32520			VR-H2009-6H	105	9660055080			VR-H2009-160	94
	37300-32800			VR-H2009-78	106	9666030280			VR-H2009-160	94
	37300-33010			VR-H2009-78	106	9L8T-10300-AB			VR-H2009-140	92
	37300-33013			VR-H2009-78	106	9L8T-10300AC			VR-H2009-140	92
	37300-33030			VR-H2009-78	106	9L8Z-10300A			VR-H2009-140	92
	37300-33100			VR-H2009-78	106	9L8Z-10346A			VR-H2009-140	92
	37300-33101			VR-H2009-78	106	A000B0331			VR-H2009-75	106
	37300-33103			VR-H2009-78	106	A000B0431			VR-H2009-75	106
	37300-35020			VR-H2009-6H	105	A001T03191	RM-147	208		
	37300-42354	RM-183H	211	VR-H2009-67	104	A001T04495	RM-147	208		
	37300-42356	RM-183H	211	VR-H2009-67	104	A002T01976			VR-H2009-185	96
	37300-42360			VR-H2009-128	91	A002T19991			VR-H2009-26	99
	37300-42456			VR-H2009-128	91	A002T34477			VR-H2009-26	99
	37300-42459			VR-H2009-128	91	A002T72576	RM-73	220		
	37300-45001			VR-H2009-203	98	A002T73676			VR-H2009-193B	97
	37300-45100			VR-H2009-191B	97	A002TB2891			VR-H2009-107	88
	37300-45101			VR-H2009-191B	97	A002TB2891ZC			VR-H2009-107	88
	37300-4A001			VR-H2009-128	91	A002TB2991			VR-H2009-107	88
	37300-4A002			VR-H2009-128	91	A002TB6291			VR-H2009-107	88
	37300-4A003			VR-H2009-128	91	A002TC1591			VR-H2009-113	89
	37300-4A110			VR-H2009-128	91	A002TC1591ZC			VR-H2009-113	89
	37300-4A111			VR-H2009-128	91	A002TC1591ZCKD			VR-H2009-113	89
	37700-21030	RM-04HV	204			A002TG1391	RM-226HV	213	VR-H2009-126	91
	37700-21320	RM-04HV	204			A002TG1391ZD	RM-226HV	213		
	37900-21030	RM-12	206	VR-H2009-4H	102	A002TJ0281	RM-180HV	210	VR-H2009-148	93
	40Q			VR-H2009-21	98	A002TL0091			VR-H2009-210	98
	4119-18-300	RM-75	220			A002TX0391			VR-H2009-140	92
	4130-18-300	RM-75	220			A002TX0391ZC			VR-H2009-140	92
	4199-18-300	RM-75	220			A002TX0481			VR-H2009-189	96
	4606075	RM-131HV	207			A002TX1381			VR-H2009-188	96
	4609075	RM-125HV	207			A002TX2581ZD	RM-178C	210		
	4609101	RM-53HV	217			A003T06791			VR-H2009-26	99
	4609125	RM-53HV	217			A003T35278	RM-76	220		
	4609300	RM-131HV	207			A003T35299A	RM-76	220		
	4609320	RM-53HV	217			A003TA8199			VR-H2009-207B	98
	4661998	RM-53HV	217			A003TB2691G			VR-H2009-105SE	88
	4671041	RM-53HV	217			A003TB2691H			VR-H2009-105SE	88
	4686106	RM-53HV	217			A003TB2691J			VR-H2009-170	94
	4793189;	RM-53HV	217			A003TB2691K			VR-H2009-170	94
	4801477AA	RM-199	211			A003TB5391			VR-H2009-93	108
	4801490AA	RM-203	212			A003TG1581			VR-H2009-169	94
	4813-18-300			VR-H2009-51	103	A003TG4191	RM-193HD	211		
	4W73-10300AC	RM-189H	211	VR-H2009-98	109	A003TG5381RL			VR-H2009-145	92
	4W7Z-10346AC	RM-189H	211	VR-H2009-98	109	A003TG5591ZC			VR-H2009-102	87
	5001866377	RM-210HV	212	VR-H2009-154B	93	A003TJ3591			VR-H2009-180	96
	5010480765	RM-210HV	212	VR-H2009-154B	93	A003TJ3691	RM-179	210	VR-H2009-130	91
	5705.EG			VR-H2009-160	94	A003TV0691ZC	RM-245HD	214	VR-H2009-218	99
	5705.KW			VR-H2009-160	94	A003TX0091			VR-H2009-140	92
	5M5T-10300AA			VR-H2009-199	97	A003TX0091ZC			VR-H2009-140	92
	5M5T-10300AB			VR-H2009-199	97	A003TX0692ZC	RM-216HD	213		
	5M5T-10300DA			VR-H2009-199	97	A003TX1291ZC			VR-H2009-140	92
	6661611			VR-H2009-75	106	A004A3F30771			VR-H2009-199	97
	6E5T-10300AB			VR-H2009-98	109	A004A3F38071			VR-H2009-199	97
	6E5T-10300AD			VR-H2009-98	109	A004T25788			VR-H2009-69	104
	6E5T-10300BA	RM-208	212			A004T40286			VR-H2009-77B	106

CROSS REFERENCE LIST

OEM Alternator No. → Mobiletron No.

OEM Alternator No.	Rectifier No.	Page	Regulator No.	Page	OEM Alternator No.	Rectifier No.	Page	Regulator No.	Page
A004T40289			VR-H2009-77B	106	A1TA1891A			VR-H2009-110	89
A004T40386			VR-H2009-77B	106	A1TA1991			VR-H2009-110	89
A004T40389			VR-H2009-77B	106	A1TA2291			VR-H2009-112	89
A004T70086			VR-H2009-77B	106	A1TA2293			VR-H2009-112	89
A004T70099			VR-H2009-77B	106	A1TA2491			VR-H2009-110	89
A004T70189			VR-H2009-77B	106	A1TA3391			VR-H2009-105	88
A004T95099			VR-H2009-77B	106	A1TA3392C			VR-H2009-105	88
A004TA8191	RM-169HV	210	VR-H2009-125B	91	A1TG0091			VR-H2009-110	89
A004TA8591			VR-H2009-125B	91	A2R20191			VR-H2009-26	99
A004TJ0181ZC			VR-H2009-98	109	A2T00991	RM-07HV	205	VR-H2009-4H	102
A004TJ0282			VR-H2009-164	94	A2T01077	RM-18	210		
A004TJ0282ZE			VR-H2009-164	94	A2T01384	RM-20HV	212	VR-H2009-28	100
A004TJ0382			VR-H2009-195	97	A2T01483	RM-20HV	212	VR-H2009-28	100
A004TJ0382ZE			VR-H2009-195	97	A2T01583	RM-20HV	212	VR-H2009-28	100
A004TR5491AT			VR-H2009-183B	96	A2T01683	RM-20HV	212	VR-H2009-28	100
A004TR6393ZT			VR-H2009-183B	96	A2T01783	RM-20HV	212	VR-H2009-28	100
A004TR6491AT			VR-H2009-132B	91	A2T01976	RM-18	210		
A004TU3088			VR-H2009-77B	106	A2T02084	RM-20HV	212	VR-H2009-28	100
A004TU3186			VR-H2009-77B	106	A2T02271	RM-07HV	205	VR-H2009-6H	105
A005T03092			VR-H2009-103	87	A2T02394	RM-12	206	VR-H2009-15	93
A005T03192			VR-H2009-103	87	A2T02394B	RM-12	206	VR-H2009-8H	107
A005TA6291G			VR-H2009-105	88	A2T02471	RM-07HV	205	VR-H2009-6H	105
A005TJ0191			VR-H2009-171	95	A2T03072	RM-11	205	VR-H2009-4H	102
A005TJ0191ZD			VR-H2009-171	95	A2T03471	RM-07HV	205	VR-H2009-6H	105
A005TJ0191ZE			VR-H2009-171	95	A2T03477	RM-07HV	205	VR-H2009-6H	105
A005TL0191A	RM-238	214			A2T03591	RM-19	211		
A005TL0491	RM-237	214	VR-H2009-209	98	A2T03691	RM-07HV	205	VR-H2009-4H	102
A009TU5591A			VR-H2009-197B	97	A2T03791	RM-19	211		
A009TU5591ZT			VR-H2009-197B	97	A2T03792	RM-07HV	205	VR-H2009-4H	102
A11578MI	RM-226HV	213			A2T03892	RM-11	205	VR-H2009-4H	102
A1T01691			VR-H2009-32	100	A2T03972	RM-07HV	205	VR-H2009-6H	105
A1T01991	RM-04HV	204	VR-H2009-4H	102	A2T04271			VR-H2009-6H	105
A1T02291			VR-H2009-20	98	A2T04474			VR-H2009-4H	102
A1T02292			VR-H2009-20	98	A2T04992			VR-H2009-6H	105
A1T02592	RM-03HV	204			A2T05192			VR-H2009-15	93
A1T02871	RM-60	218			A2T05772	RM-16	209	VR-H2009-7H	106
A1T03191			VR-H2009-14N	93	A2T05892	RM-10HV	205	VR-H2009-7H	106
A1T03191ZC	RM-147	208			A2T05892C			VR-H2009-99	109
A1T03195	RM-22	213	VR-H2009-14N	93	A2T05893	RM-10HV	205	VR-H2009-7H	106
A1T03391			VR-H2009-34	100	A2T06384			VR-H2009-28	100
A1T03791			VR-H2009-34	100	A2T06871			VR-H2009-6H	105
A1T04892			VR-H2009-20	98	A2T07577	RM-24	214	VR-H2009-4H	102
A1T06391	RM-124	206	VR-H2009-63	104	A2T09493	RM-10HV	205	VR-H2009-6H	105
A1T06672	RM-124	206	VR-H2009-63	104	A2T09591			VR-H2009-65	104
A1T06791			VR-H2009-63	104	A2T09691			VR-H2009-6H	105
A1T06891			VR-H2009-63	104	A2T09792	RM-11	205	VR-H2009-6H	105
A1T22771	RM-60	218			A2T09884			VR-H2009-28	100
A1T22971	RM-60	218	VR-H2009-3	100	A2T10083			VR-H2009-28	100
A1T23277	RM-62	219			A2T12371	RM-68	219	VR-H2009	87
A1T23283	RM-60	218			A2T12671	RM-68	219		
A1T23377	RM-63	219	VR-H2009	87	A2T13391C	RM-100	205	VR-H2009-49	102
A1T23479			VR-H2009-53	103	A2T13391D	RM-100	205		
A1T25077	RM-60	218			A2T13391E	RM-100	205		
A1T25083	RM-60	218	VR-H2009-3	100	A2T13471	RM-08HV	205		
A1T25191			VR-H2009	87	A2T13571	RM-12	206	VR-H2009-4H	102
A1T25477	RM-60	218			A2T13571A			VR-H2009-4H	102
A1T31371	RM-62	219	VR-H2009	87	A2T13894			VR-H2009-15	93
A1T31374	RM-63	219			A2T13977	RM-31	215	VR-H2009-33	100
A1T31377	RM-60	218			A2T14376			VR-H2009-28	100
A1T31699			VR-H2009	87	A2T14591			VR-H2009-49	102
A1T32084			VR-H2009-18	96	A2T14592			VR-H2009-49	102
A1T32779			VR-H2009-53	103	A2T14694			VR-H2009-15	93
A1T33576	RM-78	221			A2T14792			VR-H2009-6H	105
A1T33676	RM-78	221			A2T14876			VR-H2009-28	100
A1T3377	RM-63	219			A2T15384			VR-H2009-18	96
A1T40391	RM-15	208	VR-H2009-4H	102	A2T16371	RM-68	219		
A1T40491	RM-01HV	204	VR-H2009-4H	102	A2T16471	RM-68	219	VR-H2009	87
A1T40791	RM-04HV	204	VR-H2009-4H	102	A2T16471A			VR-H2009	87
A1T40891	RM-04HV	204	VR-H2009-4H	102	A2T16477	RM-68	219		
A1T70379	RM-105	205			A2T16871	RM-68	219	VR-H2009	87
A1T70783	RM-60	218			A2T16874			VR-H2009	87
A1T70883	RM-60	218			A2T17172	RM-68	219		
A1T71076	RM-78	221			A2T17491			VR-H2009-49	102
A1T71176	RM-78	221			A2T17574	RM-98	222	VR-H2009-26	99
A1T71276	RM-78	221			A2T17692			VR-H2009-6H	105
A1T71576	RM-78	221			A2T17783	RM-18	210		
A1TA0091	RM-124	206	VR-H2009-63	104	A2T17872			VR-H2009-4H	102
A1TA0291	RM-124	206	VR-H2009-63	104	A2T18177			VR-H2009-33	100
A1TA0491	RM-124	206	VR-H2009-63	104	A2T18277			VR-H2009-33	100
A1TA0591			VR-H2009-63	104	A2T18792			VR-H2009-15	93
A1TA0691			VR-H2009-63	104	A2T18874	RM-98	222	VR-H2009-33	100
A1TA0791	RM-124	206	VR-H2009-63	104	A2T19677	RM-31	215	VR-H2009-33	100
A1TA0891	RM-124	206			A2T19877	RM-31	215	VR-H2009-33	100
A1TA0991			VR-H2009-63	104	A2T19991	RM-31	215	VR-H2009-26	99
A1TA1891			VR-H2009-110	89	A2T20091	RM-37	216	VR-H2009-7H	106

CROSS REFERENCE
Voltage Regulator

CROSS REFERENCE
Rectifier

CROSS REFERENCE
Diode Trio

ALTERNATOR NO.
Reg & Rec

CROSS REFERENCE LIST

OEM Alternator No. → Mobiletron No.

	OEM Alternator No.	Rectifier No.	Page	Regulator No.	Page	OEM Alternator No.	Rectifier No.	Page	Regulator No.	Page
CROSS REFERENCE Voltage Regulator	A2T20191	RM-31	215	VR-H2009-26	99	A2T40377	RM-83	221	VR-H2009	87
	A2T20191ZC			VR-H2009-26	99	A2T40483	RM-73	220		
	A2T20972	RM-68	219			A2T40484	RM-73	220		
	A2T21191			VR-H2009-26	99	A2T40571	RM-83	221		
	A2T23071	RM-68	219			A2T40577	RM-83	221		
	A2T23171			VR-H2009	87	A2T40671	RM-83	221	VR-H2009-6H	105
	A2T23271	RM-68	219	VR-H2009	87	A2T40971			VR-H2009-3	100
	A2T23277			VR-H2009	87	A2T41191	RM-83	221	VR-H2009	87
	A2T23471	RM-69	220	VR-H2009	87	A2T41371	RM-83	221	VR-H2009	87
	A2T23474	RM-68	219	VR-H2009	87	A2T41377	RM-83	221	VR-H2009	87
CROSS REFERENCE Rectifier	A2T23477	RM-69	220	VR-H2009	87	A2T41477	RM-73	220		
	A2T23494	RM-68	219			A2T41483	RM-73	220		
	A2T24172	RM-68	219			A2T41599	RM-73	220		
	A2T24272	RM-68	219			A2T41674	RM-08HV	205		
	A2T24371	RM-68	219			A2T41677	RM-08HV	205	VR-H2009-4H	102
	A2T24372	RM-68	219			A2T41791	RM-07HV	205	VR-H2009-4H	102
	A2T24377	RM-68	219			A2T41899	RM-73	220		
	A2T24671	RM-68	219			A2T41991	RM-07HV	205	VR-H2009-4H	102
	A2T24771	RM-68	219	VR-H2009	87	A2T42777	RM-07HV	205	VR-H2009-4H	102
	A2T24884			VR-H2009-54	103	A2T43183	RM-73	220		
CROSS REFERENCE Diode Trio	A2T24971	RM-68	219	VR-H2009-3	100	A2T43583	RM-73	220	VR-H2009-18	96
	A2T24972	RM-68	219			A2T43791	RM-07HV	205	VR-H2009-4H	102
	A2T25071	RM-69	220			A2T43891	RM-07HV	205	VR-H2009-4H	102
	A2T25170			VR-H2009	87	A2T43892	RM-07HV	205	VR-H2009-4H	102
	A2T25171	RM-75	220	VR-H2009	87	A2T44991			VR-H2009-4H	102
	A2T25377			VR-H2009-51	103	A2T45272	RM-06	204		
	A2T25378			VR-H2009-51	103	A2T45272A	RM-06	204		
	A2T25470			VR-H2009-53	103	A2T46172			VR-H2009	87
	A2T25479	RM-71	220			A2T46395	RM-09HV	205	VR-H2009-8H	107
	A2T25578			VR-H2009-51	103	A2T46395B	RM-09HV	205	VR-H2009-8H	107
ALTERNATOR NO. Reg & Rec	A2T25584			VR-H2009-51	103	A2T46871	RM-08HV	205		
	A2T25598			VR-H2009-51	103	A2T47371			VR-H2009-4H	102
	A2T25679	RM-71	220			A2T47371A			VR-H2009-4H	102
	A2T25772	RM-68	219			A2T47474			VR-H2009-4H	102
	A2T26072	RM-69	220	VR-H2009	87	A2T47794	RM-24	214	VR-H2009-27	100
	A2T26172	RM-75	220	VR-H2009	87	A2T47794B			VR-H2009-8H	107
	A2T26391			VR-H2009-16	94	A2T47947			VR-H2009-4H	102
	A2T27091			VR-H2009-16	94	A2T48176	RM-06	204	VR-H2009-6H	105
	A2T27176	RM-73	220			A2T48176A			VR-H2009-6H	105
	A2T27376	RM-73	220			A2T48176B			VR-H2009-6H	105

CROSS REFERENCE LIST

OEM Alternator No. → Mobiletron No.

OEM Alternator No.	Rectifier No.	Page	Regulator No.	Page	OEM Alternator No.	Rectifier No.	Page	Regulator No.	Page
A2T73676			VR-H2009-193B	97	A2TC1591ZC			VR-H2009-113	89
A2T74599	RM-73	220			A2TC1591ZCKD			VR-H2009-113	89
A2T74684			VR-H2009-96B	108	A2TG0191	RM-153	209		
A2T74776			VR-H2009-96B	108	A2TG0191ZC	RM-153	209		
A2T74876			VR-H2009-96B	108	A2TG0281	RM-159	209		
A2T74976			VR-H2009-96B	108	A2TG-1081ZT	RM-161HV	209	VR-H2009-123	91
A2T75076			VR-H2009-96B	108	A2TG1391	RM-226HV	213	VR-H2009-126	91
A2T75176			VR-H2009-96B	108	A2TG1391ZD	RM-226HV	213		
A2T75282			VR-H2009-96B	108	A2TG1581			VR-H2009-122	90
A2T75376			VR-H2009-96B	108	A2TG1581AC			VR-H2009-122	90
A2T75476			VR-H2009-96B	108	A2TG4891A	RM-112HV	206		
A2T75576			VR-H2009-96B	108	A2TJ0091			VR-H2009-177	95
A2T75686	RM-73	220			A2TJ0281	RM-180HV	210	VR-H2009-148	93
A2T80591	RM-59HV	218			A2TJ0281ZC	RM-180HV	210	VR-H2009-148	93
A2T81192	RM-53HV	217			A2TJ0291	RM-180HV	210	VR-H2009-148	93
A2T81292	RM-53HV	217			A2TJ0291ZC	RM-180HV	210	VR-H2009-148	93
A2T81391	RM-53HV	217			A2TJ0391	RM-190HV	211	VR-H2009-114	89
A2T81891	RM-90	222	VR-H2009-49	102	A2TJ0391A	RM-190HV	211		
A2T82791	RM-59	218	VR-H2009-73	106	A2TJ0391B	RM-190HV	211		
A2T82792	RM-59HV	218			A2TJ0391C	RM-190HV	211		
A2T82899	RM-59	218			A2TJ0481	RM-180HV	210		
A2T82899A			VR-H2009-203	98	A2TJ0481ZC	RM-180HV	210		
A2T83291	RM-57	218			A2TJ0581			VR-H2009-130	91
A2TA0591			VR-H2009-58	103	A2TJ0591			VR-H2009-130	91
A2TA0592			VR-H2009-58	103	A2TJ0991			VR-H2009-114	89
A2TA0891ZC			VR-H2009-73	106	A2TJ1291			VR-H2009-130	91
A2TA0991	RM-59HV	218			A2TJ1291ZD			VR-H2009-130	91
A2TA1099A			VR-H2009-99	109	A2TJ1291ZE			VR-H2009-130	91
A2TA1981			VR-H2009-58	103	A2TL0091	RM-221	213	VR-H2009-210	98
A2TA1991	RM-94	222			A2TN0076	RM-152	209	VR-H2009-67	104
A2TA1991D	RM-94	222			A2TN0199			VR-H2009-67	104
A2TA1991F	RM-143	208			A2TN0299			VR-H2009-67	104
A2TA1994	RM-94	222	VR-H2009-58	103	A2TN0399			VR-H2009-67	104
A2TA1994B	RM-94	222			A2TN0499			VR-H2009-67	104
A2TA1994C	RM-94	222			A2TN0599			VR-H2009-67	104
A2TA1994D	RM-94	222			A2TN1199	RM-152	209		
A2TA2091			VR-H2009-58	103	A2TN1199A			VR-H2009-203	98
A2TA2091D	RM-94	222			A2TN1199AT			VR-H2009-203	98
A2TA2091E	RM-94	222			A2TN1481	RM-152	209		
A2TA2091F	RM-94	222			A2TN1798	RM-152	209		
A2TA2094	RM-94	222	VR-H2009-58	103	A2TN1798A			VR-H2009-203	98
A2TA2094B	RM-94	222	VR-H2009-58	103	A2TN1798AT			VR-H2009-203	98
A2TA2094C	RM-94	222			A2TN2384ZJ			VR-H2009-80	107
A2TA2094D	RM-94	222			A2TN2476	RM-152	209		
A2TA2191			VR-H2009-88	107	A2TN5084			VR-H2009-96B	108
A2TA2292			VR-H2009-49	102	A2TN5384			VR-H2009-96B	108
A2TA2392			VR-H2009-49	102	A2TX0191			VR-H2009-140	92
A2TA2492			VR-H2009-49	102	A2TX0191ZC	RM-178HD	210		
A2TA2591	RM-90	222	VR-H2009-49	102	A2TX0281	RM-203	212		
A2TA3098			VR-H2009-79	106	A2TX0881			VR-H2009-173	95
A2TA3491	RM-57	218			A2TX0881A			VR-H2009-173	95
A2TA4991			VR-H2009-70A	105	A2TX1081			VR-H2009-173	95
A2TA5191			VR-H2009-70A	105	A2TX1181			VR-H2009-176	95
A2TA5192			VR-H2009-70A	105	A2TX1381			VR-H2009-188	96
A2TA5391	RM-128	207	VR-H2009-70A	105	A2TX1781	RM-221	213	VR-H2009-176	95
A2TA6099A			VR-H2009-99	109	A2TX2581ZC	RM-178C	210		
A2TA7491	RM-53HV	217			A2TX2581ZD			VR-H2009-198	97
A2TA7591			VR-H2009-115	89	A2TX3081			VR-H2009-209	98
A2TA7691	RM-130	207	VR-H2009-115	89	A3R40672			VR-H2009-3	100
A2TB0091	RM-110HV	206	VR-H2009-95	108	A3T00491			VR-H2009-15	93
A2TB0491			VR-H2009-118	90	A3T00692	RM-34HV	215	VR-H2009-6H	105
A2TB0892			VR-H2009-70A	105	A3T00792	RM-31	215	VR-H2009-6H	105
A2TB1491	RM-126	207			A3T01496	RM-30	215	VR-H2009-11H	90
A2TB1941ZC	RM-126	207			A3T01596	RM-29HV	215		
A2TB2391			VR-H2009-95	108	A3T01596MA			VR-H2009-10A	88
A2TB2891	RM-185	211	VR-H2009-107	88	A3T01598	RM-29HV	215		
A2TB2891ZC	RM-185	211	VR-H2009-107	88	A3T01598MA			VR-H2009-10A	88
A2TB2991	RM-135	207			A3T01598NA			VR-H2009-10A	88
A2TB3091			VR-H2009-109	88	A3T01691	RM-33	215		
A2TB3891			VR-H2009-118	90	A3T01877	RM-80	221	VR-H2009-30	100
A2TB4891A			VR-H2009-85	107	A3T01877A	RM-80	221		
A2TB5391			VR-H2009-109	88	A3T01877B			VR-H2009-30	100
A2TB5491			VR-H2009-95	108	A3T02192	RM-40	216	VR-H2009-6H	105
A2TB5791	RM-128	207			A3T02193	RM-40	216	VR-H2009-6H	105
A2TB6291	RM-115	206	VR-H2009-107	88	A3T03291	RM-62	219	VR-H2009-16	94
A2TB6481			VR-H2009-112	89	A3T03292	RM-62	219	VR-H2009-16	94
A2TB7591			VR-H2009-94	108	A3T03298	RM-62	219	VR-H2009-16	94
A2TB7951	RM-154HV	209			A3T03391	RM-40	216		
A2TC0591			VR-H2009-182	96	A3T03392	RM-40	216		
A2TC0691			VR-H2009-94	108	A3T03393	RM-40	216	VR-H2009-6H	105
A2TC0981			VR-H2009-112	89	A3T03493	RM-40	216	VR-H2009-6H	105
A2TC0982			VR-H2009-112	89	A3T03891	RM-42	216		
A2TC1391	RM-181	210	VR-H2009-113	89	A3T04177			VR-H2009-30	100
A2TC1391ZC			VR-H2009-113	89	A3T04178			VR-H2009-30	100
A2TC1591			VR-H2009-113	89	A3T04292	RM-34HV	215	VR-H2009-6H	105

CROSS REFERENCE
Voltage Regulator

CROSS REFERENCE
Rectifier

CROSS REFERENCE
Diode Trio

ALTERNATOR NO.
Reg & Rec

CROSS REFERENCE LIST

OEM Alternator No. → Mobiletron No.

OEM Alternator No.	Rectifier No.	Page	Regulator No.	Page	OEM Alternator No.	Rectifier No.	Page	Regulator No.	Page
A3T04493	RM-40	216	VR-H2009-6H	105	A3TA2391A			VR-H2009-129	91
A3T04999	RM-165H	209			A3TA3098	RM-116	206	VR-H2009-79	106
A3T05192	RM-44	217			A3TA3098A			VR-H2009-120	90
A3T05676			VR-H2009-30	100	A3TA4191	RM-131HV	207		
A3T06099	RM-165H	209			A3TA4191ZC	RM-131HV	207		
A3T07592	RM-45	217	VR-H2009-22	99	A3TA4298	RM-146	208		
A3T08293	RM-40	216			A3TA4298A			VR-H2009-120	90
A3T08491	RM-46	217	VR-H2009-22	99	A3TA4691			VR-H2009-70A	105
A3T08591	RM-46	217	VR-H2009-22	99	A3TA4791			VR-H2009-70A	105
A3T08699	RM-116	206			A3TA5291			VR-H2009-70A	105
A3T08799	RM-116	206			A3TA5491			VR-H2009-70A	105
A3T08891			VR-H2009-26	99	A3TA5691	RM-134	207	VR-H2009-108	88
A3T09198			VR-H2009-79	106	A3TA5691ZC	RM-134	207		
A3T09199			VR-H2009-79	106	A3TA6098			VR-H2009-79	106
A3T09678A			VR-H2009-120	90	A3TA6098A			VR-H2009-120	90
A3T09698	RM-116	206	VR-H2009-79	106	A3TA7991	RM-231HV	214		
A3T09698A			VR-H2009-120	90	A3TA8199	RM-116	206	VR-H2009-207B	98
A3T09699	RM-116	206	VR-H2009-79	106	A3TB1081	RM-127	207	VR-H2009-100	87
A3T09798A			VR-H2009-120	90	A3TB1081A			VR-H2009-100	87
A3T09799	RM-116	206	VR-H2009-79	106	A3TB1891			VR-H2009-109	88
A3T11591			VR-H2009-38	101	A3TB1999			VR-H2009-120	90
A3T11678			VR-H2009-67	104	A3TB19999KD			VR-H2009-120	90
A3T12691			VR-H2009-15	93	A3TB2691	RM-155HV	209	VR-H2009-170	94
A3T12991			VR-H2009-38	101	A3TB2691K			VR-H2009-170	94
A3T13091			VR-H2009-38	101	A3TB3491	RM-139	208		
A3T13191			VR-H2009-38	101	A3TB4291			VR-H2009-99	109
A3T13291			VR-H2009-38	101	A3TB5291			VR-H2009-93	93
A3T14292	RM-131HV	207			A3TB5391			VR-H2009-93	108
A3T21277	RM-75	220			A3TB6581			VR-H2009-126	91
A3T21278	RM-74	220	VR-H2009	87	A3TB6781			VR-H2009-126	91
A3T21371	RM-75	220	VR-H2009	87	A3TG1491			VR-H2009-172	95
A3T21471	RM-75	220			A3TG1581			VR-H2009-169	94
A3T21584			VR-H2009-54	103	A3TG1591			VR-H2009-172	95
A3T21677	RM-75	220	VR-H2009-3	100	A3TG1891	RM-220HV	213		
A3T32172	RM-75	220			A3TG1991	RM-201	212	VR-H2009-169	94
A3T32271	RM-75	220			A3TG2391	RM-184	211	VR-H2009-107	88
A3T32272	RM-75	220			A3TG2491	RM-182	211		
A3T32377	RM-75	220			A3TG2491ZC	RM-182	211		
A3T32674	RM-75	220			A3TG2681	RM-127	207		
A3T32771	RM-75	220			A3TG2681AE			VR-H2009-122	90
A3T32772	RM-75	220	VR-H2009	87	A3TG2681ZE			VR-H2009-145	92
A3T32872	RM-75	220			A3TG3181			VR-H2009-159	93
A3T32877	RM-75	220	VR-H2009	87	A3TG3291ZD			VR-H2009-199	97
A3T32977			VR-H2009-51	103	A3TG3791			VR-H2009-159	93
A3T32989			VR-H2009-51	103	A3TG4091	RM-201	212	VR-H2009-172	95
A3T33272	RM-75	220			A3TG4181			VR-H2009-172	95
A3T33377	RM-75	220			A3TG4191	RM-193HD	211	VR-H2009-172	95
A3T33678	RM-96	222	VR-H2009-51	103	A3TG4679			VR-H2009-159	93
A3T33684	RM-96	222	VR-H2009-51	103	A3TG4791	RM-182	211		
A3T33698	RM-96	222	VR-H2009-51	103	A3TG5281ZEB	RM-220HV	213		
A3T33772	RM-75	220	VR-H2009-3	100	A3TG5381RL			VR-H2009-145	92
A3T33977	RM-75	220			A3TG5691			VR-H2009-126	91
A3T34077	RM-74	220			A3TJ0191	RM-192	211	VR-H2009-114	89
A3T34391	RM-74	220			A3TJ0291			VR-H2009-114	89
A3T34572	RM-74	220	VR-H2009	87	A3TJ0691	RM-194	211	VR-H2009-130	91
A3T34672	RM-74	220	VR-H2009	87	A3TJ0781	RM-168	209	VR-H2009-130	91
A3T34677	RM-74	220	VR-H2009	87	A3TJ0891			VR-H2009-98	109
A3T35091	RM-74	220			A3TJ0891ZC			VR-H2009-98	109
A3T35278	RM-76	220	VR-H2009-56	103	A3TJ0991	RM-208	212		
A3T35299			VR-H2009-56	103	A3TJ0991ZC	RM-208	212	VR-H2009-98	109
A3T40672			VR-H2009-3	100	A3TJ1091			VR-H2009-114	89
A3T41591	RM-47	217			A3TJ1181			VR-H2009-114	89
A3T41876	RM-40	216	VR-H2009-6H	105	A3TJ1191			VR-H2009-114	89
A3T41892	RM-40	216	VR-H2009-6H	105	A3TJ1791	RM-179	210	VR-H2009-130	91
A3T45191	RM-62	219			A3TJ1791A	RM-207	212		
A3T45693			VR-H2009-6H	105	A3TJ1791ZC	RM-179	210	VR-H2009-130	91
A3T45694	RM-40	216	VR-H2009-6H	105	A3TJ1991	RM-199	211		
A3T68071			VR-H2009-17	94	A3TJ1991A	RM-199	211		
A3T75883	RM-170	210	VR-H2009-80B	107	A3TJ1991B	RM-199	211	VR-H2009-130	91
A3T76071			VR-H2009-17	94	A3TJ2481	RM-213	212		
A3T76072			VR-H2009-17	94	A3TJ2581	RM-199	211		
A3T76073			VR-H2009-17	94	A3TJ3281			VR-H2009-114	89
A3T76075			VR-H2009-17	94	A3TJ3591			VR-H2009-180	96
A3T77071			VR-H2009-17	94	A3TJ3691	RM-179	210	VR-H2009-130	91
A3TA0591	RM-87	222			A3TJ3691ZC	RM-179	210	VR-H2009-130	91
A3TA0591C	RM-87	222			A3TN0078			VR-H2009-67	104
A3TA0591D	RM-87	222			A3TN0199			VR-H2009-67	104
A3TA0591E	RM-87	222			A3TN0299			VR-H2009-67	104
A3TA0591F	RM-87	222			A3TN0399			VR-H2009-67	104
A3TA0593C	RM-87	222			A3TN0499			VR-H2009-67	104
A3TA0791	RM-87	222	VR-H2009-38	101	A3TN0699			VR-H2009-67	104
A3TA0991A			VR-H2009-93	108	A3TN1281A			VR-H2009-203	98
A3TA1691			VR-H2009-70A	105	A3TN15099			VR-H2009-67	104
A3TA2291A			VR-H2009-70A	105	A3TN1791	RM-99HV	222	VR-H2009-82	107
A3TA2391			VR-H2009-129	91	A3TN5188	RM-170	210	VR-H2009-80B	107

CROSS REFERENCE
Voltage Regulator

CROSS REFERENCE
Rectifier

CROSS REFERENCE
Diode Trio

ALTERNATOR NO.
Reg & Rec

CROSS REFERENCE LIST

OEM Alternator No. → Mobiletron No.

OEM Alternator No.	Rectifier No.	Page	Regulator No.	Page	OEM Alternator No.	Rectifier No.	Page	Regulator No.	Page
A3TN5288			VR-H2009-80B	107	A4TA0594			VR-H2009-135B	92
A3TN5379			VR-H2009-205B	98	A4TA8191	RM-169HV	210	VR-H2009-125B	91
A3TN5379ZC			VR-H2009-205B	98	A4TA8291			VR-H2009-135B	92
A3TN5387			VR-H2009-205B	98	A4TA8292			VR-H2009-135B	92
A3TN5399			VR-H2009-205B	98	A4TA8591			VR-H2009-125B	91
A3TN5684			VR-H2009-96B	108	A4TJ0084C	RM-222HV	213	VR-H2009-196	97
A3TN6579			VR-H2009-96B	108	A4TJ0181	RM-189H	211	VR-H2009-98	109
A3TN6679			VR-H2009-96B	108	A4TJ0181ZC	RM-189H	211	VR-H2009-98	109
A3TO1496MA			VR-H2009-11H	90	A4TJ0281			VR-H2009-164	94
A3TR0091			VR-H2009-153	93	A4TJ0282	RM-200	212	VR-H2009-164	94
A3TR0091ZT			VR-H2009-153	93	A4TJ0381			VR-H2009-195	97
A3TR0093			VR-H2009-153	93	A4TJ0382			VR-H2009-195	97
A3TR0093ZT			VR-H2009-153	93	A4TJ0581			VR-H2009-164	94
A3TR0094			VR-H2009-153	93	A4TJ0582			VR-H2009-164	94
A3TR0094ZT			VR-H2009-153	93	A4TJ0582ZE			VR-H2009-164	94
A3TR0188ZT	RM-205	212			A4TR5091			VR-H2009-154B	93
A3TU1791B	RM-207	212			A4TR5091ZT			VR-H2009-154B	93
A3TX0091			VR-H2009-140	92	A4TR5188			VR-H2009-151B	93
A3TX0481	RM-239	214			A4TR5191			VR-H2009-151B	93
A3TX0692ZC	RM-216HD	213			A4TR5191ZT	RM-210HV	212	VR-H2009-151B	93
A3TX1291ZC			VR-H2009-140	92	A4TR5391			VR-H2009-132BA	91
A3TX1691			VR-H2009-212	98	A4TR5491			VR-H2009-183B	96
A4A3F13271			VR-H2009-199	97	A4TR5591ZT			VR-H2009-132B	91
A4A3F30771			VR-H2009-199	97	A4TR5691			VR-H2009-183B	96
A4A3F38062			VR-H2009-199	97	A4TR5894ZT			VR-H2009-132B	91
A4A3F38071			VR-H2009-199	97	A4TR6191			VR-H2009-183B	96
A4A3R30062			VR-H2009-141	92	A4TR6191AM			VR-H2009-183B	96
A4T00796	RM-41	216	VR-H2009-25	99	A4TR6293ZT			VR-H2009-183B	96
A4T00891	RM-89	222	VR-H2009-59	103	A4TR6491AT			VR-H2009-132B	91
A4T00991	RM-89	222	VR-H2009-49	102	A4TU0088			VR-H2009-161	94
A4T00991C			VR-H2009-49	102	A4TU3085	RM-120	206		
A4T00991D			VR-H2009-49	102	A4TU3186	RM-120	206		
A4T01493	RM-43	216	VR-H2009-41	101	A5R01577			VR-H2009-26	99
A4T01793			VR-H2009-41	101	A5R41592			VR-H2009-23	99
A4T01893	RM-43	216	VR-H2009-41	101	A5T00192	RM-14	208	VR-H2009-103	87
A4T02591	RM-48	217	VR-H2009-37	101	A5T00272	RM-85	221		
A4T02891	RM-82	221	VR-H2009-59	103	A5T00777			VR-H2009-33	100
A4T02891A	RM-82	221			A5T00877	RM-23	213	VR-H2009-24	99
A4T02891B	RM-82	221			A5T00972			VR-H2009-24	99
A4T02892	RM-82	221	VR-H2009-59	103	A5T01577	RM-23	213	VR-H2009-26	99
A4T02892A	RM-82	221			A5T01892	RM-81	221		
A4T02991			VR-H2009-41	101	A5T01977	RM-23	213	VR-H2009-26	99
A4T03091			VR-H2009-41	101	A5T02377			VR-H2009-35	100
A4T03191	RM-43	216	VR-H2009-41	101	A5T02777	RM-23	213	VR-H2009-24	99
A4T03292	RM-82	221	VR-H2009-59	103	A5T03391			VR-H2009-22	99
A4T03292A	RM-82	221			A5T03677	RM-23	213	VR-H2009-22	99
A4T03392	RM-89	222	VR-H2009-49	102	A5T03777	RM-23	213	VR-H2009-22	99
A4T03492	RM-89	222	VR-H2009-49	102	A5T04072			VR-H2009-20	98
A4T25172	RM-60	218	VR-H2009	87	A5T04092			VR-H2009-40	101
A4T25199	RM-60	218	VR-H2009	87	A5T04292	RM-27	214	VR-H2009-20	98
A4T30399			VR-H2009	87	A5T06291			VR-H2009-20	98
A4T40286	RM-120	206			A5T06391	RM-28	214		
A4T40289	RM-120	206			A5T06491ZC			VR-H2009-50	103
A4T40386	RM-120	206			A5T06591	RM-209	212		
A4T56771			VR-H2009-17	94	A5T07091	RM-22	213		
A4T56772			VR-H2009-17	94	A5T07091ZC			VR-H2009-44	101
A4T56773			VR-H2009-17	94	A5T07092ZC			VR-H2009-44	101
A4T56871			VR-H2009-17	94	A5T10271	RM-66	219		
A4T57371			VR-H2009-17	94	A5T15171	RM-66	219	VR-H2009	87
A4T57471			VR-H2009-17	94	A5T15177	RM-66	219		
A4T57472			VR-H2009-17	94	A5T15371	RM-66	219	VR-H2009	87
A4T57789			VR-H2009-47	102	A5T15471	RM-66	219	VR-H2009	87
A4T57886			VR-H2009-47	102	A5T15584	RM-65	219	VR-H2009	87
A4T58289			VR-H2009-69B	105	A5T15684	RM-65	219		
A4T58686			VR-H2009-69B	105	A5T15784	RM-65	219		
A4T58689			VR-H2009-69B	105	A5T15884	RM-65	219		
A4T58699			VR-H2009-69B	105	A5T16471	RM-02HV	204	VR-H2009-9H	109
A4T58786			VR-H2009-69B	105	A5T20374	RM-66	219	VR-H2009	87
A4T58799			VR-H2009-69B	105	A5T20377	RM-66	219	VR-H2009	87
A4T58986			VR-H2009-69B	105	A5T20484	RM-65	219	VR-H2009	87
A4T58989			VR-H2009-69B	105	A5T20571	RM-66	219	VR-H2009	87
A4T58999			VR-H2009-69B	105	A5T20577	RM-66	219		
A4T59086			VR-H2009-69B	105	A5T20871	RM-85	221		
A4T59199			VR-H2009-69B	105	A5T20872	RM-85	221		
A4T59786			VR-H2009-69B	105	A5T20972			VR-H2009-3	100
A4T65571			VR-H2009-17	94	A5T21071	RM-66	219	VR-H2009	87
A4T65671			VR-H2009-17	94	A5T21077	RM-66	219	VR-H2009	87
A4T65988			VR-H2009-47	102	A5T21171	RM-66	219		
A4T66486			VR-H2009-69B	105	A5T21471	RM-67	219	VR-H2009	87
A4T66786			VR-H2009-69B	105	A5T21472	RM-67	219		
A4T75586			VR-H2009-69B	105	A5T21684	RM-65	219		
A4T75589			VR-H2009-69B	105	A5T21871	RM-85	221	VR-H2009-3	100
A4TA0091D			VR-H2009-59	103	A5T21897	RM-85	221		
A4TA0591			VR-H2009-135B	92	A5T22484	RM-65	219	VR-H2009-18	96
A4TA0592			VR-H2009-135B	92	A5T22578	RM-86	222	VR-H2009-48	102

CROSS REFERENCE
Voltage Regulator

CROSS REFERENCE
Rectifier

CROSS REFERENCE
Diode Trio

ALTERNATOR NO.
Reg & Rec

CROSS REFERENCE LIST

OEM Alternator No. → Mobiletron No.

OEM Alternator No.	Rectifier No.	Page	Regulator No.	Page	OEM Alternator No.	Rectifier No.	Page	Regulator No.	Page
A5T22583	RM-86	222	VR-H2009-48	102	A7TA0477			VR-H2009-64	104
A5T22971B	RM-81	221			A7TA3377	RM-240	214	VR-H2009-120	90
A5T22997	RM-81	221			A9TU5591			VR-H2009-197B	97
A5T22997B	RM-81	221			A9TU5591A			VR-H2009-197B	97
A5T23277	RM-66	219	VR-H2009	87	A9TU5591ZT			VR-H2009-197B	97
A5T30171	RM-67	219			AA5T-10300BA			VR-H2009-140	92
A5T30574	RM-01HV	204	VR-H2009-4H	102	AA5T-10300BB			VR-H2009-140	92
A5T30871	RM-15	208	VR-H2009-4H	102	AA5Z-10346B			VR-H2009-140	92
A5T30977	RM-01HV	204	VR-H2009-9H	109	AB150021			VR-H2009-6A	105
A5T31177	RM-15	208	VR-H2009-9H	109	AB160108	RM-124	206		
A5T31277	RM-15	208			AB175015	RM-10HV	205		
A5T31971	RM-15	208	VR-H2009-9H	109	AB175019	RM-10HV	205		
A5T31971A	RM-15	208	VR-H2009-9H	109	AB175020	RM-41	216	VR-H2009-78	106
A5T40374	RM-15	208	VR-H2009-4H	102	AB190025			VR-H2009-78	106
A5T41094			VR-H2009-6H	105	AB190072			VR-H2009-78	106
A5T41474	RM-01HV	204	VR-H2009-4H	102	AB190119			VR-H2009-78	106
A5T41477	RM-15	208			AC155515			VR-H2009-75	106
A5T41592	RM-05HV	204	VR-H2009-23	99	AC155603			VR-H2009-75	106
A5T41592B	RM-05HV	204	VR-H2009-23	99	AC155604			VR-H2009-75	106
A5T70178	RM-86	222	VR-H2009-12	90	AC155614			VR-H2009-75	106
A5T70183	RM-86	222	VR-H2009-12	90	AC155643			VR-H2009-75	106
A5T70283	RM-86	222	VR-H2009-12	90	AC165617			VR-H2009-75	106
A5T70383			VR-H2009-12	90	AF111225			VR-H2009-128	91
A5TA0091	RM-129	207			AF111382			VR-H2009-128	91
A5TA0291			VR-H2009-73	106	AF111390			VR-H2009-128	91
A5TA0991			VR-H2009-71	105	AF111393			VR-H2009-128	91
A5TA0991ZC	RM-129	207			AF175476			VR-H2009-128	91
A5TA1191ZC			VR-H2009-62	104	AHGA19			VR-H2009-50	103
A5TA2491	RM-145	208			AHGA35			VR-H2009-152	93
A5TA2491ZC	RM-145	208			AHGA53	RM-154HV	209		
A5TA2591			VR-H2009-83	107	AHGA55	RM-154HV	209	VR-H2009-94	108
A5TA3591			VR-H2009-152	93	AHGA58			VR-H2009-144	92
A5TA3891	RM-129A	207			AHGA61			VR-H2009-94	108
A5TA3891A	RM-129A	207			AHGA65	RM-154HV	209		
A5TA4291	RM-145	208	VR-H2009-90	108	AHGA75			VR-H2009-113	89
A5TA4291ZC	RM-145	208	VR-H2009-90	108	AHGA77	RM-175	210	VR-H2009-139	92
A5TA4391			VR-H2009-83	107	AHGA81			VR-H2009-171	95
A5TA4591	RM-129A	207	VR-H2009-152	93	AHGA88	RM-233	214		
A5TA6291			VR-H2009-105	88	AHGA92			VR-H2009-204	98
A5TA6291A			VR-H2009-105	88	AHGA95			VR-H2009-204	98
A5TA6291C			VR-H2009-105	88	AJ51-18-300			VR-H2009-114	89
A5TA6292			VR-H2009-105	88	AJ51-18-W70			VR-H2009-114	89
A5TA6292C			VR-H2009-105	88	AJ57-18-300A			VR-H2009-114	89
A5TA6292F	RM-202	212	VR-H2009-105	88	AQ2240K1	RM-68	219	VR-H2009	87
A5TA6292G	RM-202	212	VR-H2009-105SE	88	AQ2245G	RM-68	219	VR-H2009	87
A5TA6391			VR-H2009-105SE	88	AQ2245G1	RM-68	219	VR-H2009	87
A5TA6391A			VR-H2009-105SE	88	AQ2245G7			VR-H2009	87
A5TA6391B			VR-H2009-105SE	88	AQ2245K1	RM-68	219	VR-H2009	87
A5TA6391C			VR-H2009-105SE	88	AQ2250	RM-68	219		
A5TA6392C			VR-H2009-105SE	88	AQ2250G1	RM-68	219	VR-H2009	87
A5TA6591			VR-H2009-83	107	AQ2250G7	RM-68	219		
A5TA7091	RM-136	208			AQ2250K1	RM-68	219	VR-H2009	87
A5TA7191	RM-136	208			AQ2250K7			VR-H2009	87
A5TA7792			VR-H2009-102	87	AQ2355G1	RM-75	220		
A5TB0291ZD			VR-H2009-144	92	AR160A	RM-04HV	204	VR-H2009-4H	102
A5TB1391	RM-158H	209	VR-H2009-119	90	AT506591			VR-H2009-37	101
A5TG0091	RM-176	210			B101-18-300			VR-H2009-9H	109
A5TG0192B			VR-H2009-160	94	B10-18-300A			VR-H2009-9H	109
A5TG0881ZEB	RM-202	212			B113-18-300B			VR-H2009-24	99
A5TG0991			VR-H2009-110	89	B359-18-300			VR-H2009-4H	102
A5TG1392			VR-H2009-160	94	B366-18-300			VR-H2009-22	99
A5TG1392A			VR-H2009-160	94	B36618300G			VR-H2009-26	99
A5TG1392B			VR-H2009-160	94	B3C7-18-300			VR-H2009-22	99
A5TJ0091	RM-175	210	VR-H2009-139	92	B601-18-300	RM-12	206		
A5TJ0191			VR-H2009-171	95	B603-18-300	RM-01HV	204	VR-H2009-9H	109
A5TJ0191ZC			VR-H2009-171	95	B603-18-300A	RM-15	208	VR-H2009-9H	109
A5TJ0191ZD	RM-224	213	VR-H2009-171	95	B612-18-300A	RM-08HV	205		
A5TJ0191ZE			VR-H2009-171	95	B617-18-300	RM-08HV	205		
A5TL0191A	RM-238	214			B61P-18-300			VR-H2009-22	99
A5TL0491	RM-237	214	VR-H2009-209	98	B64J-18-300B			VR-H2009-22	99
A5TL0581ZC	RM-233	214	VR-H2009-208	98	B655-18-300	RM-12	206	VR-H2009-4H	102
A5TZ0091			VR-H2009-204	98	B655-18-300A	RM-11	205	VR-H2009-4H	102
A6182-C2119-3912Y	RM-237	214			B665-18-300	RM-12	206	VR-H2009-22	99
A641			VR-H2009-21	98	B675-18-300A	RM-10HV	205	VR-H2009-7H	106
A6T41491			VR-H2009-43	101	B675-18-300B	RM-10HV	205	VR-H2009-7H	106
A6T41591			VR-H2009-43	101	B675-18-300C	RM-16	209		
A6T55186			VR-H2009-69B	105	BE5T-10300AA			VR-H2009-140	92
A6T55189			VR-H2009-69B	105	BL1T-10300BB	RM-216HD	213		
A6T65199			VR-H2009-19	97	BL1Z-10346A	RM-216HD	213		
A6T75186			VR-H2009-47	102	BP02-18-300	RM-23	213		
A6T75286			VR-H2009-47	102	BP02-18-300A			VR-H2009-24	99
A7T02077A			VR-H2009-64	104	CA1652IR			VR-H2009-112	89
A7T02874			VR-H2009-45	101	D401-18-300	RM-63	219		
A7T03371A			VR-H2009-201	98	D501-18-300	RM-62	219	VR-H2009	87
A7T03771A			VR-H2009-201	98	DG1T-10300CA			VR-H2009-140	92

CROSS REFERENCE
Voltage Regulator

CROSS REFERENCE
Rectifier

CROSS REFERENCE
Diode Trio

ALTERNATOR NO.
Reg & Rec

CROSS REFERENCE LIST

OEM Alternator No. → Mobiletron No.

OEM Alternator No.	Rectifier No.	Page	Regulator No.	Page	OEM Alternator No.	Rectifier No.	Page	Regulator No.	Page
DG1Z-10346A			VR-H2009-140	92	GY011-8300R	RM-127	207		
E301-18-300C	RM-75	220	VR-H2009	87	GY011-8W9XA	RM-127	207		
E301-18-300D	RM-75	220	VR-H2009	87	H612-18-300	RM-63	219		
E302-18-300	RM-69	220	VR-H2009	87	H834-18-300	RM-83	221		
E303-18-300	RM-68	219			HE19-18-300A	RM-83	221		
E331-18-300A	RM-67	219			HE19-18-300B	RM-08HV	205		
E356-18-300A	RM-15	208	VR-H2009-4H	102	HE21-18-300A	RM-74	220		
E563-18-300A	RM-67	219	VR-H2009	87	HE26-18-300B	RM-74	220		
E5A1-18-300A	RM-67	219			HE41-18-300	RM-83	221	VR-H2009	87
E7GZ-10346A	RM-01HV	204	VR-H2009-9H	109	HE45-18-300	RM-66	219	VR-H2009	87
E804-10346B	RM-12	206			HE4518300A	RM-66	219		
E83F-10300AA	RM-29HV	215	VR-H2009-10A	88	JA500C03801			VR-H2009-157	93
E83F-10300AB	RM-29HV	215	VR-H2009-10A	88	JE15-18-300A	RM-31	215	VR-H2009-33	100
E83F-10300BA	RM-29HV	215	VR-H2009-10A	88	JE27-18-300			VR-H2009-33	100
E83Z-10346A	RM-29HV	215	VR-H2009-10A	88	JE28-18-300			VR-H2009-33	100
E8BZ-10346A			VR-H2009-9H	109	JE48-18-300	RM-45	217	VR-H2009-22	99
E8BZ-10346B			VR-H2009-9H	109	JF07-18-300			VR-H2009-33	100
E8DF-10300AB			VR-H2009-10A	88	JFZ1711			VR-H2009-157	93
E8DZ-10346A			VR-H2009-10A	88	JFZ1929C(new)	RM-236			
E8GY-10346A			VR-H2009-4H	102	K801-18-300			VR-H2009-22	99
E8GY-10346B	RM-11	205	VR-H2009-4H	102	K801-18-300C	RM-46	217		
E8GY-10346C	RM-10HV	205	VR-H2009-7H	106	KK339-18300			VR-H2009-6A	105
E8GY-10346D	RM-10HV	205	VR-H2009-7H	106	L3M6-18-300A			VR-H2009-114	89
E8SF-10300AA	RM-30	215	VR-H2009-11H	90	L3M6-18-300B			VR-H2009-114	89
E8SF-10346A	RM-30	215			LF1F-18-300	RM-182	211		
E8SZ-10346A			VR-H2009-11H	90	LFB6-18-300			VR-H2009-114	89
E92Z-10346A	RM-10HV	205	VR-H2009-7H	106	LK1ST-10300AB			VR-H2009-199	97
E92Z-10346B			VR-H2009-7H	106	M13NI 18 300B	RM-119H	206	VR-H2009-6H	105
E9BZ-10346A			VR-H2009-4H	102	M13NI-18-300B			VR-H2009-6HL	105
E9DF-10300BB			VR-H2009-15	93	MD006187	RM-68	219	VR-H2009	87
E9PZ-10316A			VR-H2009-15	93	MD006197	RM-68	219		
E9SF-10300DA	RM-41	216	VR-H2009-25	99	MD007509	RM-68	219	VR-H2009	87
E9SZ-10346A			VR-H2009-25	99	MD009052	RM-68	219	VR-H2009	87
F0CZ-10346B			VR-H2009-24	99	MD009053	RM-68	219	VR-H2009	87
F202-18-300	RM-10HV	205	VR-H2009-7H	106	MD009054	RM-68	219	VR-H2009	87
F225-18-300	RM-10HV	205			MD013740	RM-65	219	VR-H2009-18	96
F262-18-300	RM-10HV	205			MD015020	RM-83	221		
F28518300C			VR-H2009-26	99	MD015021	RM-83	221		
F285-18-300C	RM-31	215			MD015040	RM-66	219		
F2F8-18300B			VR-H2009-7H	106	MD015041	RM-66	219		
F2G8-18-300			VR-H2009-35	100	MD018230	RM-75	220	VR-H2009	87
F2JY-10346A			VR-H2009-33	100	MD019179	RM-83	221		
F32Z-10346A	RM-59HV	218			MD022572	RM-68	219	VR-H2009	87
F356-18-300A	RM-01HV	204			MD022576	RM-75	220		
F3DZ-10346A			VR-H2009-43	101	MD022578	RM-68	219	VR-H2009	87
F3LU-10300BC	RM-47	217	VR-H2009-43	101	MD022579	RM-68	219	VR-H2009	87
F3LY-10346A	RM-54HV	218			MD025215			VR-H2009	87
F3XA-10300AB	RM-48	217			MD025677	RM-75	220	VR-H2009	87
F3XA-10300AC	RM-48	217	VR-H2009-38	101	MD025679	RM-75	220	VR-H2009	87
F601-18-300A	RM-83	221			MD027660	RM-68	219		
F651-18-300	RM-01HV	204			MD027661	RM-68	219		
F651-18-300B			VR-H2009-9H	109	MD034130	RM-66	219	VR-H2009	87
F65118300C	RM-15	208			MD034132	RM-66	219	VR-H2009	87
F807-18-300A	RM-83	221			MD041700	RM-68	219	VR-H2009	87
F820-18-300			VR-H2009-4H	102	MD041705	RM-75	220		
F82M-18-300			VR-H2009-182	96	MD041706	RM-75	220		
F873-18-300A	RM-15	208			MD050190	RM-73	220	VR-H2009-54	103
F87318300B	RM-15	208			MD050194			VR-H2009-54	103
F881-18-300A	RM-10HV	205	VR-H2009-7H	106	MD060901			VR-H2009	87
F88B-18-300B	RM-10HV	205			MD061150			VR-H2009-6H	105
F8B1-18-300A	RM-10HV	205			MD061430	RM-73	220		
FE01-18-300B	RM-83	221	VR-H2009	87	MD061818	RM-65	219	VR-H2009	87
FE05-18-300B	RM-74	220			MD062007			VR-H2009	87
FE65-18-300B	RM-15	208			MD063781	RM-66	219	VR-H2009	87
FE6518300C	RM-15	208			MD064066	RM-66	219	VR-H2009	87
FE68-18-300			VR-H2009-4H	102	MD064067	RM-66	219	VR-H2009	87
FE68-18-300B			VR-H2009-4H	102	MD064068	RM-66	219	VR-H2009	87
FE68-18-300C	RM-08HV	205			MD068565	RM-65	219		
FE85-18-300	RM-01HV	204	VR-H2009-9H	109	MD069859	RM-65	219		
FELC-18-300			VR-H2009-22	99	MD069978	RM-01HV	204	VR-H2009-4H	102
FL1T-10300-AA	RM-245HD	214	VR-H2009-218	99	MD072582	RM-65	219	VR-H2009-18	96
FL1Z-10346-A	RM-245HD	214			MD073067	RM-07HV	205	VR-H2009-4H	102
FOBZ-10346A			VR-H2009-9H	109	MD074644	RM-07HV	205	VR-H2009-4H	102
FOCZ-10346B			VR-H2009-9H	109	MD074645	RM-83	221	VR-H2009-4H	102
FS05-18-300			VR-H2009-22	99	MD074992	RM-01HV	204	VR-H2009-4H	102
FS1118300A			VR-H2009-22	99	MD082419	RM-07HV	205	VR-H2009-4H	102
FW73-10346AC	RM-189H	211			MD086016	RM-65	219		
GE01-18-300	RM-62	219	VR-H2009	87	MD086046	RM-74	220	VR-H2009	87
GLE-254			VR-H2009-11H	90	MD086047	RM-74	220	VR-H2009	87
GLE-261			VR-H2009-15	93	MD086048	RM-74	220	VR-H2009	87
GLE-265	RM-41	216	VR-H2009-25	99	MD087246	RM-73	220	VR-H2009-18	96
GRE-796			VR-H2009-15	93	MD091793	RM-07HV	205	VR-H2009-4H	102
GY01-18-300E			VR-H2009-100	87	MD091794	RM-07HV	205	VR-H2009-4H	102
GY011-8300E	RM-127	207			MD091849	RM-04HV	204	VR-H2009-4H	102
GY01-18-300R			VR-H2009-100	87	MD091850	RM-04HV	204	VR-H2009-4H	102

CROSS REFERENCE
Voltage Regulator

CROSS REFERENCE
Rectifier

CROSS REFERENCE
Diode Trio

ALTERNATOR NO.
Reg & Rec

CROSS REFERENCE LIST

OEM Alternator No. → Mobiletron No.

	OEM Alternator No.	Rectifier No.	Page	Regulator No.	Page	OEM Alternator No.	Rectifier No.	Page	Regulator No.	Page
CROSS REFERENCE Voltage Regulator	MD099621	RM-18	210	VR-H2009-185	96	MD313384			VR-H2009-129	91
	MD099624	RM-07HV	205	VR-H2009-4H	102	MD313392			VR-H2009-73	106
	MD099625	RM-07HV	205	VR-H2009-4H	102	MD313939	RM-59HV	218		
	MD102084			VR-H2009-6H	105	MD314235	RM-59	218		
	MD102085	RM-07HV	205	VR-H2009-6H	105	MD314236	RM-59HV	218		
	MD102088	RM-07HV	205	VR-H2009-6H	105	MD314374	RM-59	218		
	MD102864			VR-H2009-28	100	MD315430	RM-59HV	218		
	MD102865			VR-H2009-28	100	MD317401	RM-57	218		
	MD103372	RM-20HV	212	VR-H2009-28	100	MD317530	RM-124	206	VR-H2009-63	104
	MD103373	RM-20HV	212	VR-H2009-28	100	MD317531	RM-124	206	VR-H2009-63	104
MD103564	RM-20HV	212	VR-H2009-28	100	MD317862	RM-128	207			
MD104744	RM-66	219	VR-H2009	87	MD318460			VR-H2009-129	91	
MD105339			VR-H2009-6H	105	MD319045			VR-H2009-63	104	
MD105606	RM-18	210	VR-H2009-185	96	MD319317			VR-H2009-63	104	
MD106319	RM-20HV	212	VR-H2009-28	100	MD319575			VR-H2009-63	104	
MD106320	RM-20HV	212	VR-H2009-28	100	MD327535	RM-59HV	218			
MD106332	RM-20HV	212	VR-H2009-28	100	MD344310			VR-H2009-80	107	
MD106508	RM-11	205	VR-H2009-4H	102	MD354802			VR-H2009-93	108	
MD106713	RM-11	205	VR-H2009-6H	105	MD354804			VR-H2009-129	91	
MD108230	RM-07HV	205	VR-H2009-6H	105	MD366051			VR-H2009-203	98	
MD108305	RM-07HV	205	VR-H2009-4H	102	MD366052			VR-H2009-203	98	
MD108509	RM-07HV	205	VR-H2009-6H	105	MD373093	RM-139	208			
MD109166	RM-07HV	205	VR-H2009-6H	105	MD607680	RM-73	220			
MD109741	RM-07HV	205	VR-H2009-4H	102	ME001570	RM-86	222	VR-H2009-48	102	
MD110318	RM-07HV	205	VR-H2009-6H	105	ME007396			VR-H2009-17	94	
MD111151	RM-07HV	205	VR-H2009-4H	102	ME007397			VR-H2009-17	94	
MD111233	RM-40	216	VR-H2009-6H	105	ME007533			VR-H2009-17	94	
MD111607	RM-07HV	205	VR-H2009-4H	102	ME007540			VR-H2009-17	94	
MD112318			VR-H2009-28	100	ME007550			VR-H2009-17	94	
MD112322			VR-H2009-6H	105	ME007577	RM-86	222	VR-H2009-48	102	
MD112323	RM-34HV	215			ME007578	RM-86	222	VR-H2009-12	90	
MD114620			VR-H2009-6H	105	ME007582	RM-73	220			
MD117156	RM-11	205	VR-H2009-6H	105	ME011886	RM-120	206			
MD122338			VR-H2009-6H	105	ME015164			VR-H2009-69	104	
MD124233			VR-H2009-28	100	ME017507			VR-H2009-17	94	
MD124234			VR-H2009-28	100	ME017509			VR-H2009-17	94	
MD125569	RM-11	205	VR-H2009-6H	105	ME017516			VR-H2009-17	94	
MD126110	RM-40	216	VR-H2009-6H	105	ME017550			VR-H2009-17	94	
MD127087			VR-H2009-28	100	ME017552			VR-H2009-17	94	
MD132130			VR-H2009-28	100	ME017553			VR-H2009-17	94	
MD133171	RM-40	216			ME017560	RM-86	222	VR-H2009-12	90	
MD134315			VR-H2009-6H	105	ME017561	RM-86	222	VR-H2009-12	90	
MD135825	RM-165H	209			ME017562	RM-73	220			
MD136838	RM-40	216	VR-H2009-78	106	ME017563			VR-H2009-47	102	
MD136839	RM-40	216	VR-H2009-6H	105	ME017585	RM-73	220			
MD140247			VR-H2009-6H	105	ME017588			VR-H2009-47	102	
MD141855	RM-40	216	VR-H2009-6H	105	ME017602	RM-73	220			
MD147246	RM-165H	209			ME017614			VR-H2009-205B	98	
MD150657	RM-43	216	VR-H2009-33	100	ME017615			VR-H2009-80B	107	
MD158495	RM-40	216			ME017632			VR-H2009-77B	106	
MD168989	RM-40	216			ME037370			VR-H2009-17	94	
MD175810	RM-57	218	VR-H2009-38	101	ME037371			VR-H2009-17	94	
MD175811	RM-36	215	VR-H2009-38	101	ME037372			VR-H2009-17	94	
MD177244	RM-57	218	VR-H2009-38	101	ME037481			VR-H2009-17	94	
MD184278	RM-36	215	VR-H2009-38	101	ME037482			VR-H2009-17	94	
MD184279	RM-57	218	VR-H2009-38	101	ME037593			VR-H2009-17	94	
MD184280	RM-36	215	VR-H2009-38	101	ME037616	RM-73	220			
MD184281	RM-57	218	VR-H2009-38	101	ME037640	RM-73	220	VR-H2009-47	102	
MD189658	RM-36	215	VR-H2009-38	101	ME037641			VR-H2009-47	102	
MD189659	RM-57	218	VR-H2009-38	101	ME037644			VR-H2009-47	102	
MD190812			VR-H2009-38	101	ME037989			VR-H2009-47	102	
MD190819	RM-50HV	217	VR-H2009-38	101	ME049165			VR-H2009-12	90	
MD191402	RM-36	215	VR-H2009-38	101	ME049281			VR-H2009-205B	98	
MD191578			VR-H2009-38	101	ME049321			VR-H2009-205B	98	
MD193323	RM-57	218			ME057658	RM-73	220			
MD194466			VR-H2009-38	101	ME057701			VR-H2009-69B	105	
MD194482	RM-59HV	218			ME060076			VR-H2009-69B	105	
MD195437	RM-57	218			ME067522	RM-73	220			
MD196857			VR-H2009-38	101	ME067529			VR-H2009-47	102	
MD196858			VR-H2009-38	101	ME067611			VR-H2009-17	94	
MD197470	RM-43	216			ME067614			VR-H2009-17	94	
MD198164	RM-50HV	217			ME067617			VR-H2009-17	94	
MD198648			VR-H2009-38	101	ME067622	RM-73	220			
MD198649			VR-H2009-38	101	ME067630			VR-H2009-17	94	
MD300720	RM-124	206	VR-H2009-63	104	ME067631			VR-H2009-17	94	
MD304129	RM-59HV	218			ME067632			VR-H2009-17	94	
MD305885	RM-124	206	VR-H2009-63	104	ME067635			VR-H2009-17	94	
MD305886			VR-H2009-63	104	ME067640			VR-H2009-17	94	
MD306649	RM-59	218			ME067641			VR-H2009-17	94	
MD309331			VR-H2009-63	104	ME067642			VR-H2009-17	94	
MD309837	RM-57	218			ME067644			VR-H2009-17	94	
MD310997	RM-59HV	218			ME077137			VR-H2009-69B	105	
MD311138	RM-124	206	VR-H2009-63	104	ME077138			VR-H2009-69B	105	
MD311711	RM-124	206	VR-H2009-63	104	ME077404			VR-H2009-69B	105	
MD311712	RM-124	206	VR-H2009-63	104	ME077574			VR-H2009-69B	105	

CROSS REFERENCE
Voltage Regulator

CROSS REFERENCE
Rectifier

CROSS REFERENCE
Diode Trio

ALTERNATOR NO.
Reg & Rec

CROSS REFERENCE LIST

OEM Alternator No. → Mobiletron No.

OEM Alternator No.	Rectifier No.	Page	Regulator No.	Page	OEM Alternator No.	Rectifier No.	Page	Regulator No.	Page
ME077788	RM-120	206	VR-H2009-77B	106	V757692180	RM-220HV	213		
ME077789	RM-120	206			V757695680	RM-202	212		
ME077789			VR-H2009-77B	106	XF52-10300AC	RM-134	207	VR-H2009-108	88
ME077790			VR-H2009-77B	106	XF5Z-10346AA	RM-134	207	VR-H2009-108	88
ME077869			VR-H2009-77B	106	Z599-18-300A	RM-110HV	206		
ME087501	RM-73	220			ZJ38-18-300	RM-226HV	213	VR-H2009-126	91
ME087566			VR-H2009-69B	105	NIKKO				
ME087567			VR-H2009-69B	105	0-33000-0050			VR-H2003-1B	110
ME087595	RM-73	220			0-33000-0060			VR-H2003-1B	110
ME087630			VR-H2009-69B	105	0-33000-0071			VR-H2003-1B	110
ME087642	RM-73	220			0-33000-0120			VR-H2003-1B	110
ME087643			VR-H2009-69B	105	0-33000-2200			VR-H2003-1B	110
ME08887			VR-H2009-205B	98	0-33000-2280			VR-H2003-1B	110
ME090198			VR-H2009-69B	105	0-33000-2290			VR-H2003-1B	110
ME090592			VR-H2009-69B	105	0-33000-2800			VR-H2003-1B	110
ME091136			VR-H2009-69B	105	0-33000-2841			VR-H2003-1B	110
ME091535			VR-H2009-69B	105	0-33000-2870			VR-H2003-1B	110
ME092899	RM-120	206	VR-H2009-77B	106	0-33000-2871			VR-H2003-1B	110
ME093221			VR-H2009-69B	105	0-33000-2880			VR-H2003-1B	110
ME093222			VR-H2009-69B	105	0-33000-3070			VR-H2003-1B	110
ME093245	RM-120	206	VR-H2009-77B	106	0-33000-3071			VR-H2003-1B	110
ME093246			VR-H2009-77B	106	0-33000-3130			VR-H2003-1B	110
ME093474			VR-H2009-69B	105	0-33000-3700			VR-H2003-1B	110
ME108147			VR-H2009-207B	98	0-33000-3710			VR-H2003-1B	110
ME150001			VR-H2009-69B	105	0-33000-3760			VR-H2003-1B	110
ME150093			VR-H2009-69B	105	0-33000-3810			VR-H2003-1B	110
ME150142			VR-H2009-69B	105	0-33000-3970			VR-H2003-1B	110
ME150143			VR-H2009-69B	105	0-33000-4400			VR-H2003-1B	110
ME150650			VR-H2009-69B	105	0-33000-4402			VR-H2003-1B	110
ME150651			VR-H2009-69B	105	0-33000-4670			VR-H2003-1B	110
ME150963			VR-H2009-69B	105	0-33000-4750			VR-H2003-1B	110
ME151974	RM-120	206			0-33000-5100			VR-H2003-1B	110
ME160917			VR-H2009-77B	106	0-33000-5280			VR-H2003-1B	110
ME160918			VR-H2009-77B	106	1-81200-206-0			VR-H2003-1B	110
ME192608	RM-205	212	VR-H2009-175	95	1-81200-209-0			VR-H2003-1B	110
ME202755			VR-H2009-120	90	1-81200-234-0			VR-H2003-1B	110
ME203546			VR-H2009-120	90	1-81200-265-0			VR-H2003-1B	110
ME700836	RM-73	220			1-81200-314-0			VR-H2003-1B	110
N221-18-300	RM-66	219	VR-H2009	87	1-81200-459-0			VR-H2003-1B	110
N225-18-300A	RM-08HV	205			1-81200-536-0			VR-H2003-1B	110
N236-18-300	RM-74	220			1-81200-541-0			VR-H2003-1B	110
N245-18-300B	RM-08HV	205			1-81200-541-1			VR-H2003-1B	110
N249-18-300			VR-H2009-4H	102	1-81200-544-1			VR-H2003-1B	110
N249-18-300B	RM-01HV	204	VR-H2009-4H	102	1-81200-545-0			VR-H2003-1B	110
N304-18-300	RM-01HV	204	VR-H2009-4H	102	1-81200-545-1			VR-H2003-1B	110
N304-18-300B	RM-01HV	204	VR-H2009-4H	102	1-81200-549-0			VR-H2003-1B	110
N318-18-300			VR-H2009-4H	102	1-81200-551-0			VR-H2003-1B	110
N320-18-300			VR-H2009-4H	102	1-81200-554-0			VR-H2003-1B	110
N326-18-300			VR-H2009-4H	102	1-81200-558-0			VR-H2003-1B	110
N39018300A			VR-H2009-26	99	1-81200-585-0			VR-H2003-1B	110
N3A1-18-300			VR-H2009-22	99	1-81200-844-0			VR-H2003-1B	110
OK72A-18300			VR-H2009-4A	102	5-81200-212-0			VR-H2003-1B	110
RF03-18-300C	RM-73	220			PRESTOLITE				
RFG7-18-300			VR-H2009-22	99	AC203RA			VR-LC401	
S201-18-300			VR-H2009-53	103	SAWAFUJI				
S201-18-300A			VR-H2009-53	103	0201-102-1020			VR-H2002-2	111
S241-18-300			VR-H2009-53	103	0201-102-1210			VR-H2002-2	111
S241-18-300A			VR-H2009-53	103	0201-102-1220			VR-H2002-2	111
S50218300C	RM-71	220			0201-102-1310			VR-H2002-2	111
S51518300	RM-78	221			0201-102-1410			VR-H2002-2	111
S515-18-300	RM-78	221			0201-102-1710			VR-H2002-2	111
S51618300	RM-73	220			0201-102-2020			VR-H2002-2	111
SE4518300	RM-78	221			0201-102-2610			VR-H2002-2	111
SE45-18-300	RM-78	221			0201-102-2921			VR-H2002-1	111
SE4718300	RM-73	220			0201-102-2963			VR-H2002-1	111
SL0118300	RM-78	221			0201-102-3110			VR-H2002-1	111
SL01-18-300	RM-78	221			0201-102-3112			VR-H2002-1	111
SL0718300	RM-78	221			0201-152-0010			VR-H2002-1	111
SL07-18-300	RM-78	221			0201-152-0021			VR-H2002-1	111
SL2118300A	RM-73	220			0201-152-0043			VR-H2002-1	111
SL2418300	RM-73	220			0201-152-0053			VR-H2002-1	111
SL4418300A	RM-78	221			0201-172-0013			VR-H2002-1	111
SL44-18-300A	RM-78	221			0201-172-0112			VR-H2002-1	111
SL5018300C	RM-78	221			0201-172-0121			VR-H2002-1	111
SL50-18-300C	RM-78	221			0201-202-0011			VR-H2002-1	111
SL5618300A	RM-73	220			0201-202-0210			VR-H2002-1	111
SLA1-18-300B			VR-H2009-193B	97	0201-222-0013			VR-H2002-1	111
T46070			VR-H2009-21	98	0201-222-0023			VR-H2002-1	111
TA000A48201			VR-H2009-128	91	0201-222-0113			VR-H2002-1	111
TA000A-48401	RM-151	208			0201-222-0220			VR-H2002-1	111
TA000A-48402	RM-151	208			0201-222-0262			VR-H2002-1	111
TA000A54701			VR-H2009-128	91	0201-222-0272			VR-H2002-1	111
TA000A56901			VR-H2009-128	91	0201-222-0312			VR-H2002-1	111
TA000A57301			VR-H2009-128	91	0201-222-0412			VR-H2002-1	111
TA000A57401			VR-H2009-128	91	0201-222-0421			VR-H2002-1	111

CROSS REFERENCE
Voltage Regulator

CROSS REFERENCE
Rectifier

CROSS REFERENCE
Diode Trio

ALTERNATOR NO.
Reg & Rec

CROSS REFERENCE LIST

OEM Alternator No. → Mobiletron No.

OEM Alternator No.	Rectifier No.	Page	Regulator No.	Page	OEM Alternator No.	Rectifier No.	Page	Regulator No.	Page
0202-102-1010			VR-H2002-2	111	11258	RP-72	223	VR-V0447	112
0202-102-1011			VR-H2002-2	111	11260			VR-V3231	114
0202-102-1020			VR-H2002-2	111	11261			VR-V3231	114
0202-102-1110			VR-H2002-2	111	11265			VR-V0441	112
0202-102-1111			VR-H2002-2	111	11266			VR-V0441	112
0202-102-1120			VR-H2002-2	111	11313			VR-V0441	112
0202-102-1121			VR-H2002-2	111	11319			VR-V3788	115
0202-102-1211			VR-H2002-2	111	11355			VR-V3231	114
0202-102-1310			VR-H2002-2	111	11358			VR-V3231	114
0202-102-1411			VR-H2002-2	111	11393			VR-V3536	115
0202-102-1510			VR-H2002-2	111	11394			VR-V2604	113
0202-102-1811			VR-H2002-1	111	11397			VR-V2604	113
0202-102-1823			VR-H2002-1	111	11451			VR-V2604	113
0202-102-1910			VR-H2002-1	111	11457			VR-V7059	117
0202-102-1921			VR-H2002-1	111	11491			VR-V9938	119
0202-102-1933			VR-H2002-1	111	11493			VR-V9938	119
0202-102-1943			VR-H2002-1	111	11515			VR-V015	112
0202-152-0010			VR-H2002-1	111	11612			VR-V8054	118
0202-152-0021			VR-H2002-1	111	11648			VR-V8689	119
0202-152-0033			VR-H2002-1	111	11651			VR-V7144	118
0202-152-0043			VR-H2002-1	111	11693			VR-V7131	118
0202-152-0123			VR-H2002-1	111	11706			VR-V8060	118
0202-202-0011			VR-H2002-1	111	11810			VR-V3722	115
0202-222-0012			VR-H2002-1	111	12317516098			VR-V2263	113
0202-222-0023			VR-H2002-1	111	12317516721			VR-V2263	113
0202-222-0110			VR-H2002-1	111	12317516722			VR-V2263	113
0202-222-0142			VR-H2002-1	111	12317521178	RP-59	223	VR-V3231	114
0202-222-0152			VR-H2002-1	111	12317525376	RP-59	223	VR-V3231	114
0202-222-0211			VR-H2002-1	111	12317533469			VR-V2604	113
0202-222-0222			VR-H2002-1	111	12-31-7-535-098			VR-V3591	115
0210-102-2020			VR-H2002-2	111	12317550968			VR-V3231	114
0214-202-0310			VR-H2002-2	111	12317551256			VR-V3231	114
0214-202-0319			VR-H2002-2	111	12317555926			VR-V3231	114
0220-102-1211			VR-H2002-2	111	12317561002			VR-V2604	113
0220-102-1310			VR-H2002-2	111	12317573754			VR-V2604	113
0220-102-1411			VR-H2002-2	111	12317573755			VR-V2604	113
0220-102-1510			VR-H2002-2	111	12-31-7-576-513			VR-V3591	115
23099-96504			VR-H2002-2	111	12-31-7-576-514			VR-V3591	115
23099-96510			VR-H2002-1	111	12-31-7-615-484			VR-V3591	115
23099-965503			VR-H2002-2	111	12317801124			VR-V2604	113
23099-Z5604			VR-H2002-2	111	12317802261			VR-V2604	113
23099-Z5605			VR-H2002-2	111	12317802619			VR-V2604	113
23099-Z5615			VR-H2002-1	111	12317804266			VR-V2604	113
23099-Z5665			VR-H2002-1	111	12317823343			VR-V2988	114
23100-95015			VR-H2002-2	111	12317823344			VR-V2988	114
23100-97507			VR-H2002-1	111	13500586			VR-V5460	117
23100-Z5602			VR-H2002-2	111	13944	RP-44	223		
23100-Z5617			VR-H2002-1	111	13993	RP-44A	223		
27040-1400			VR-H2002-2	111	1469714	RP-57	223		
27040-1410			VR-H2002-2	111	15201678			VR-V0441	112
27040-1440			VR-H2002-2	111	15215546			VR-V0441	112
27040-1460			VR-H2002-2	111	15251755			VR-V0441	112
27040-1811			VR-H2002-1	111	15784559			VR-V0441	112
27050-1240			VR-H2002-2	111	15863714			VR-V0441	112
27050-1250			VR-H2002-2	111	1685793			VR-V7319	118
27050-1260			VR-H2002-2	111	1685794	RP-57	223		
27050-1270			VR-H2002-2	111	1698214	RP-57	223		
VALEO					1704769			VR-V7319	118
03L 903 017B			VR-V8060	118	20147			VR-V3788	115
04801250AB			VR-V3279	114	20148			VR-V3788	115
06E 903 018L			VR-V8060	118	20350			VR-V3788	115
06E 903 018LX			VR-V8060	118	20563			VR-V9446	119
06E903016D			VR-V2975	114	21660			VR-V3419	114
06H 903 017D			VR-V8060	118	22931			VR-V5120	116
06H 903 017K			VR-V8060	118	22966	RP-62	223		
06H-903-016S			VR-V8054	118	23100-0027R			VR-V4803	116
06J-903-023H			VR-V8052	118	23100-22DZ0A			VR-V0447	112
10317647	RP-44	223			23100-4864R			VR-V4803	116
10317648			VR-V2499	113	23100-4BA0A			VR-V8689	119
10327514			VR-V2499	113	23100-4BB0B			VR-V8689	119
10350160			VR-V2499	113	23100-5Z000			VR-V0030	112
10440635	RP-44A	223			23100-5Z020	RP-65HD	223		
11014			VR-V5428	117	23100-7865R			VR-V8689	119
11015			VR-V5001	116	23100-7Y020	RP-65HD	223	VR-V0030	112
11017	RP-65HD	223			23100-JA02A	RP-72	223	VR-V0447	112
11018	RP-65HD	223			23100-JA02B	RP-72	223	VR-V0447	112
11020			VR-V5001	116	23100-ZH00A			VR-V0447	112
11021			VR-V0441	112	23100-ZH00B			VR-V0447	112
11023			VR-V0441	112	23886			VR-V3975	116
11066			VR-V3780	115	23910			VR-V6131	117
11069	RP-66	223			24011	RP-57	223		
11141			VR-V0219	112	24052			VR-V4291	116
11148			VR-V0441	112	24130			VR-V3231	114
11189			VR-V5745	117	2524924A			VR-V2775	113
11256			VR-V0447	112	2541997			VR-V1610	113

CROSS REFERENCE
Voltage Regulator

CROSS REFERENCE
Rectifier

CROSS REFERENCE
Diode Trio

ALTERNATOR NO.
Reg & Rec

CROSS REFERENCE LIST

OEM Alternator No. → Mobiletron No.

OEM Alternator No.	Rectifier No.	Page	Regulator No.	Page	OEM Alternator No.	Rectifier No.	Page	Regulator No.	Page
2541998			VR-V1610	113	37300-03100			VR-V5633	117
2542294			VR-V1610	113	37300-23650			VR-V5745	117
2542298A			VR-V2775	113	37300-23720			VR-V005	112
2542458			VR-V2263	113	37300-25201			VR-V5745	117
2542558	RP-44	223			37300-2A110			VR-V8417	119
2542564			VR-V2599	113	37300-2B101			VR-V8326	118
2542564A			VR-V2599	113	37300-2E400			VR-V3530	115
2542582B			VR-V3780	115	37300-2G150			VR-V9938	119
2542588			VR-V3666	115	37300-2G600			VR-V9938	119
2542608			VR-V2263	113	37300-37400			VR-V5001	116
2542611			VR-V3796	116	37300-37405			VR-V5001	116
2542613			VR-V3796	116	37300-38400			VR-V5428	117
2542637			VR-V3666	115	37300-3A002			VR-V5001	116
2542693			VR-V2775	113	37300-3C250	RP-68	223	VR-V015	112
2542720			VR-V3231	114	437374			VR-V2263	113
2542726			VR-V2775	113	437407			VR-V2775	113
2542751			VR-V3666	115	437471			VR-V2775	113
2542819			VR-V3666	115	437579			VR-V3231	114
2542827			VR-V2975	114	439418			VR-V2263	113
2542832			VR-V2775	113	439502			VR-V2775	113
2542832A			VR-V2775	113	439560			VR-V3231	114
2542852A			VR-V3793	115	439602			VR-V2604	113
2542920			VR-V5120	116	439606			VR-V2604	113
2542921			VR-V5120	116	439613			VR-V2604	113
2542922			VR-V5120	116	439674			VR-V2775	113
2542923			VR-V5120	116	440183			VR-V2604	113
2542989B			VR-V3279	114	440435			VR-V8060	118
2543218			VR-V2604	113	4702118A			VR-V2118	113
2543221			VR-V3231	114	51784848			VR-V5904	117
2543223			VR-V2604	113	543461A			VR-V2604	113
2543304			VR-V3796	116	7700430183	RP-62	223		
2543343			VR-V3666	115	7701499971	RP-62	223		
2543344			VR-V3666	115	7711134926			VR-V3666	115
2543374			VR-V2975	114	7G9N-10300CA	RP-57	223		
2543427			VR-V4291	116	7G9N-10300CC	RP-57	223		
2543436			VR-V2604	113	7G9T-10300AA			VR-V7319	118
2543526A			VR-V2775	113	8200120571	RP-62	223		
2543595			VR-V3666	115	8200138269			VR-V3666	115
2543596			VR-V3666	115	8200205612	RP-62	223		
2605546			VR-V2775	113	8200290220			VR-V3666	115
2605546A			VR-V2775	113	8200757870			VR-V4803	116
2606925			VR-V0219	112	8200849752			VR-V4803	116
2606952B	RP-57	223			8V21-10300AB			VR-V4291	116
2607052			VR-V7052	117	9007561825			VR-V014	112
2607214A			VR-V5366	117	9611366880			VR-V016	112
2607372			VR-V3530	115	9646066880			VR-V2775	113
2608483			VR-V3530	115	9649611280			VR-V2775	113
2610695B			VR-V7319	118	A0002655009			VR-V5428	117
2612741			VR-V3530	115	A0002655010			VR-V5001	116
2650010	RP-44A	223	VR-V2499	113	A0002655516			VR-V5001	116
2650011B			VR-V2499	113	A0002655635			VR-V5745	117
2650016	RP-44	223			A0009062822			VR-V9446	119
2650017A			VR-V2499	113	A11V1106			VR-V3419	114
2650031	RP-65HD	223	VR-V0030	112	A11V1108			VR-V3419SE	114
2650043			VR-V0219	112	A11V1109	RP-42	223		
2650047	RP-65HD	223	VR-V0030	112	A11V1195			VR-V1610	113
2650135A	RP-44	223			A13VI223			VR-V1610	113
2650181			VR-V0441	112	A13VI241			VR-V1610	113
2650304			VR-V0441	112	A13VI276			VR-V3419	114
2650323B			VR-V0219	112	A13VI277			VR-V3419SE	114
2650323O			VR-V0219	112	A13VI278			VR-V3419	114
2650352			VR-V0441	112	A13VI279			VR-V3419SE	114
2650364	RP-72	223			A13VI283			VR-V3419	114
2650364A			VR-V0447	112	A13VI288			VR-V3419SE	114
2650364B			VR-V0447	112	A14VI34			VR-V3406SE	114
2650398			VR-V0219	112	A14VI45			VR-V3406SE	114
2650408			VR-V0219	112	A14VI46			VR-V3406SE	114
2650505			VR-V0441	112	A14VI47			VR-V3406SE	114
2650538			VR-V0447	112	A14VI48			VR-V2775	113
2650709			VR-V0219	112	A14VI49			VR-V2775	113
2655447			VR-V8326	118	A2661540602			VR-V3975	116
2655516			VR-V5001	116	A2661540902			VR-V3975	116
2655553			VR-V5001	116	A2711540902			VR-V3780	115
2655635			VR-V5745	117	AV6N-10300GB			VR-V7319	118
2661540602			VR-V3975	116	AV6N-10300GC			VR-V7319	118
2661540902			VR-V3975	116	AV6N-10300HA	RP-57	223		
27060-0Q140			VR-V0572	113	AV6N-10300MD			VR-V4291	116
27060-0T230			VR-V7131	118	AV6NGB			VR-V7319	118
27060-YV020			VR-V2775	113	AV6NGC			VR-V7319	118
31400-82Z10			VR-V0447	112	CG20U011			VR-V9446	119
37300-02550			VR-V6131	117	FG12T050			VR-V7131	118
37300-02551			VR-V6131	117	FG15S024			VR-V7144	118
37300-02570			VR-V6131	117	FG15S090			VR-V7144	118
37300-02600			VR-V7052	117	FG15T074			VR-V4291	116
37300-02700			VR-V6131	117	FG18D111			VR-V2988	114

CROSS REFERENCE
Voltage Regulator

CROSS REFERENCE
Rectifier

CROSS REFERENCE
Diode Trio

ALTERNATOR NO.
Reg & Rec

CROSS REFERENCE LIST

OEM Alternator No. → Mobiletron No.

OEM Alternator No.	Rectifier No.	Page	Regulator No.	Page	OEM Alternator No.	Rectifier No.	Page	Regulator No.	Page
FG18S019			VR-V2604	113	TG11C069			VR-V8237	118
FG18S045			VR-V2988	114	TG11C074			VR-V3975	116
FG18T063			VR-V8060	118	TG11C076			VR-V5745	117
FG20S015			VR-V8060	118	TG12C0141	RP-65HD	223		
FG20S016			VR-V8060	118	TG12C027			VR-V0219	112
FG20S017			VR-V8060	118	TG12C032	RP-72	223	VR-V0447	112
FG20S018			VR-V8060	118	TG12C037	RP-57	223		
FG20S019			VR-V8060	118	TG12C038			VR-V4291	116
FG20S022			VR-V8060	118	TG12C040			VR-V0219	112
FG23S010			VR-V3536	115	TG12C042			VR-V0219	112
FG23S033			VR-V2988	114	TG12C043			VR-V0219	112
FG9T011			VR-V0572	113	TG12C048			VR-V0219	112
FG9T013			VR-V0572	113	TG12C057			VR-V015	112
JFZ1929C			VR-V005	112	TG12C059			VR-V3591	115
JFZ1929C(new)			VR-V024	112	TG12C061			VR-V3591	115
LRA03470			VR-V7319	118	TG12C062			VR-V4803	116
LRA3470			VR-V7319	118	TG12C070			VR-V5460	117
QK2AA-18-300			VR-V5001	116	TG12C084			VR-V0219	112
RK2AA-18-300U			VR-V5001	116	TG12C087	RP-57	223	VR-V4291	116
SG10S012	RP-52	223			TG12C103			VR-V0447	112
SG10S029	RP-44A	223	VR-V2499	113	TG12C107			VR-V4291	116
SG10S034	RP-44	223			TG12C120			VR-V3591	115
SG10S035	RP-44A	223	VR-V2499	113	TG12C122			VR-V4291	116
SG10S036	RP-44	223			TG12C124			VR-V8689	119
SG10S037	RP-44A	223			TG12C149			VR-V8689	119
SG10S044	RP-44	223			TG12C152			VR-V8689	119
SG12B052			VR-V3689	115	TG12S028			VR-V0441	112
SG12B055			VR-V3689	115	TG12S047			VR-V0441	112
SG12B062			VR-V3780	115	TG12S089			VR-V0441	112
SG12B068			VR-V3689	115	TG13S012			VR-V0441	112
SG12B071			VR-V3689	115	TG13S017			VR-V0441	112
SG12B072			VR-V3689	115	TG13S018			VR-V0219	112
SG12B081			VR-V3689	115	TG13S020			VR-V0441	112
SG12B09			VR-V3689	115	TG13S021			VR-V0219	112
SG12B096			VR-V3689	115	TG13S023			VR-V0219	112
SG12B097			VR-V3689	115	TG13S028			VR-V0219	112
SG12B103			VR-V3689	115	TG13S029			VR-V0441	112
SG12B105			VR-V3689	115	TG14C018			VR-V8052	118
SG12B107			VR-V3689	115	TG14C019			VR-V3788	115
SG12B109			VR-V3689	115	TG14C020			VR-V8052	118
SG12B110			VR-V3689	115	TG14C022			VR-V3788	115
SG12B122			VR-V3689	115	TG14C028			VR-V3788	115
SG12B123			VR-V3689	115	TG14C031			VR-V3788	115
SG12S019			VR-V1658	113	TG14C035			VR-V3788	115
SG12S029	RP-44A	223			TG14C037			VR-V3722	115
SG12S035	RP-44	223			TG14C039			VR-V3788	115
SG14B023	RP-69HD	223			TG14C041			VR-V8052	118
SG15L012	RP-42	223	VR-V3779	115	TG14C043			VR-V8052	118
SG15L020			VR-V3666	115	TG14C044			VR-V3788	115
SG15L026	RP-42	223	VR-V3779	115	TG14C046			VR-V8052	118
SG15L027			VR-V3666	115	TG14C049			VR-V8052	118
SG15L034			VR-V3666	115	TG14C054			VR-V8052	118
SG15S024			VR-V2775	113	TG14C055			VR-V8052	118
SG15S025			VR-V2775	113	TG14C056			VR-V8052	118
SG9B037			VR-V3874	116	TG14C057			VR-V8052	118
SG9B038			VR-V3874	116	TG14C058			VR-V8052	118
SG9B039			VR-V3874	116	TG14C059			VR-V8052	118
SG9B040			VR-V2263	113	TG14C060			VR-V8052	118
SG9B050			VR-V2263	113	TG14C067			VR-V8052	118
SG9B089			VR-V3689	115	TG14C071			VR-V8052	118
SG9B091			VR-V014	112	TG15C020			VR-V2775	113
SG9B108			VR-V3689	115	TG15C026	RP-65HD	223		
SSG7S039			VR-V2118	113	TG15C028			VR-V2775	113
SVES082639			VR-V8060	118	TG15C038			VR-V3793	115
TG10S012			VR-V0441	112	TG15C053			VR-V2775	113
TG10S016			VR-V0441	112	TG15C057			VR-V4291	116
TG10S017			VR-V0441	112	TG15C057B			VR-V4291	116
TG10S022			VR-V0441	112	TG15C057C			VR-V4291	116
TG11C010			VR-V3689	115	TG15C058			VR-V3689	115
TG11C011			VR-V3689	115	TG15C091			VR-V8237	118
TG11C021			VR-V3975	116	TG15C103			VR-V4291	116
TG11C022			VR-V3689	115	TG15C113			VR-V0447	112
TG11C024			VR-V5001	116	TG15C118			VR-V2775	113
TG11C027			VR-V3689	115	TG15C121			VR-V4291	116
TG11C034			VR-V3689	115	TG15C125			VR-V8237	118
TG11C035			VR-V3975	116	TG15C134			VR-V2775	113
TG11C041			VR-V8237	118	TG15C169			VR-V7319	118
TG11C046			VR-V3689	115	TG15C174			VR-V7319	118
TG11C049			VR-V3689	115	TG15C183			VR-V7319	118
TG11C055			VR-V8237	118	TG15S147			VR-V0447	112
TG11C060			VR-V8237	118	TG16C014			VR-V2975	114
TG11C061			VR-V3689	115	TG17C010B			VR-V3796	116
TG11C063			VR-V3689	115	TG17C011			VR-V3796	116
TG11C064			VR-V3689	115	TG17C015			VR-V3231	114
TG11C066			VR-V8237	118	TG17C016			VR-V3231	114

CROSS REFERENCE
Voltage Regulator

CROSS REFERENCE
Rectifier

CROSS REFERENCE
Diode Trio

ALTERNATOR NO.
Reg & Rec

CROSS REFERENCE LIST

OEM Alternator No. → Mobiletron No.

OEM Alternator No.	Rectifier No.	Page	Regulator No.	Page	OEM Alternator No.	Rectifier No.	Page	Regulator No.	Page
TG17C016B			VR-V3231	114	513008B	RU-01H	225		
TG17C020			VR-V2975	114	513008C	RU-01	225		
TG17C021			VR-V3231	114	513008D	RU-01H	225		
TG17C021B			VR-V3231	114	513009			VR-DU510	120
TG17C022			VR-V2975	114	513010			VR-DU510	120
TG17C023			VR-V2975	114	513011			VR-DU510	120
TG17C024			VR-V2975	114	514005			VR-DU512	120
TG17C027			VR-V3231	114	514006A	RU-01	225		
TG17C027B			VR-V3231	114	514006B	RU-01H	225		
TG17C028			VR-V3279	114	514007CDE			VR-DU512	120
TG17C030			VR-V3279	114	514010BC			VR-DU512	120
TG17C030B			VR-V3279	114	514011			VR-DU511	120
TG17C032			VR-V3279	114	514011A	RU-01H	225		
TG17C035			VR-V3231	114	514011B	RU-01	225		
TG17C039			VR-V2975	114	514011C	RU-01H	225		
TG17C040			VR-V2975	114	514011D	RU-01	225		
TG17C044			VR-V2975	114	514012			VR-DU511	120
TG17C048			VR-V3796	116	514012A	RU-01H	225		
TG17C054			VR-V2975	114	514012B	RU-01	225		
TG17C056			VR-V2975	114	514012C	RU-01H	225		
TG23018			VR-V2604	113	514012D	RU-01	225		
TG23C011			VR-V2604	113	514013A	RU-01H	225		
TG23C012			VR-V2604	113	515001A	RU-01	225		
TG23C013			VR-V2604	113	515002			VR-DU510	120
TG23C019			VR-V7059	117	515002A	RU-01	225		
TG7S010			VR-V5120	116	515002B	RU-01H	225		
TG7S011			VR-V5120	116	515002C	RU-01	225		
TG8S017			VR-V3689	115	515003			VR-DU510	120
TG8S021			VR-V5904	117	515003A	RU-01	225		
TG8S022			VR-V5904	117	515003B	RU-01H	225		
TG8S025			VR-V3689	115	515003C	RU-01	225		
TG9B024			VR-V5120	116	515005			VR-DU510	120
TG9B025			VR-V5120	116	515006			VR-DU510	120
TG9B049			VR-V5366	117	515007			VR-DU510	120
TG9B053			VR-V3689	115	515008			VR-DU510	120
TG9B068			VR-V5366	117	515009			VR-DU510	120
TG9S014			VR-V5904	117	515009A	RU-01	225		
TG9S036	RP-80	224	VR-V5904	117	515010			VR-DU510	120
TG9S037			VR-V5904	117	515013			VR-DU510	120
TG9S039			VR-V5904	117	515014			VR-DU510	120
TG9S040			VR-V5904	117	515014A	RU-01	225		
YLE500170			VR-V3793	115	515015			VR-DU510	120
VALEO(DUCELLIER)					515015A	RU-01	225		
2074684			VR-DU509	120	515016			VR-DU510	120
2077791			VR-DU510	120	515016A	RU-01	225		
2093051			VR-DU509	120	515018A	RU-01H	225		
2093073			VR-DU510	120	516002			VR-DU514	121
2095084			VR-DU509	120	516006			VR-DU511	120
2095085			VR-DU510	120	516006A	RU-01H	225		
2095086			VR-DU509	120	516006B	RU-01	225		
2095172			VR-DU510	120	516006C	RU-01H	225		
2095228			VR-DU509	120	516006D	RU-01	225		
2095565			VR-DU510	120	516006E	RU-01H	225		
2095722			VR-DU509	120	516008			VR-DU513	121
2097295			VR-DU510	120	516009			VR-DU511	120
2097973			VR-DU509	120	516015			VR-DU511	120
2102452			VR-DU510	120	516016			VR-DU511	120
40170302			VR-DU509	120	516017			VR-DU511	120
433396			VR-DU510	120	516017A	RU-01H	225		
436305			VR-DU509	120	516017B	RU-01	225		
510-064			VR-DU510	120	516019			VR-DU514	121
510-079			VR-DU510	120	516020			VR-DU511	120
510-157			VR-DU510	120	516020A	RU-01H	225		
512001			VR-DU510	120	516020B	RU-01	225		
512002			VR-DU509	120	516020C	RU-01H	225		
512002A			VR-DU510	120	516020D	RU-01	225		
512002B			VR-DU509	120	516023			VR-DU511	120
512003			VR-DU510	120	516023A	RU-01H	225		
512003A			VR-DU509	120	516023B	RU-01	225		
512003B			VR-DU510	120	516023C	RU-01H	225		
512008			VR-DU511	120	516023D	RU-01	225		
512010			VR-DU511	120	516024			VR-DU511	120
513001			VR-DU510	120	516024A	RU-01H	225		
513001A	RU-01	225			516024B	RU-01	225		
513001B	RU-01H	225			516024C	RU-01H	225		
513001C	RU-01	225			516024D	RU-01	225		
513002			VR-DU510	120	516025			VR-DU511	120
513003			VR-DU510	120	516025A	RU-01H	225		
513003A	RU-01	225			516025B	RU-01	225		
513003B	RU-01H	225			516025C	RU-01H	225		
513003C	RU-01	225			516026			VR-DU511	120
513004			VR-DU510	120	516026A	RU-01H	225		
513005			VR-DU510	120	516026B	RU-01	225		
513008			VR-DU510	120	516027			VR-DU514	121
513008A	RU-01	225			516029			VR-DU511	120

CROSS REFERENCE
Voltage Regulator

CROSS REFERENCE
Rectifier

CROSS REFERENCE
Diode Trio

ALTERNATOR NO.
Reg & Rec

CROSS REFERENCE LIST

OEM Alternator No. → Mobiletron No.

OEM Alternator No.	Rectifier No.	Page	Regulator No.	Page	OEM Alternator No.	Rectifier No.	Page	Regulator No.	Page
516030			VR-DU511	120	7527			VR-DU510	120
516032			VR-DU512	120	7527B	RU-01	225		
516033			VR-DU511	120	7527C	RU-01H	225		
516033A	RU-01H	225			7528B			VR-DU509	120
516033B	RU-01	225			7528C			VR-DU510	120
516033C	RU-01H	225			7529			VR-DU510	120
516034			VR-DU511	120	7531			VR-DU509	120
516035A	RU-01H	225	VR-DU513	121	7531B			VR-DU510	120
516035B	RU-01	225	VR-DU513	121	7532			VR-DU510	120
516035C	RU-01H	225			7533			VR-DU510	120
516037A	RU-01	225			7534			VR-DU510	120
516037B	RU-01H	225			7535			VR-DU510	120
516037C	RU-01	225			7543			VR-DU509	120
516038A	RU-01H	225			7543A			VR-DU510	120
516038B	RU-01	225			7543B			VR-DU509	120
516038C	RU-01H	225			7545			VR-DU510	120
516041			VR-DU515	121	7545A			VR-DU509	120
516042			VR-DU511	120	7548			VR-DU510	120
516044A	RU-01H	225			7548A	RU-01	225		
516044B	RU-01	225			7549A	RU-01H	225		
516044C	RU-01H	225			7549B	RU-01	225		
516045			VR-DU511	120	7549C	RU-01H	225		
516046			VR-DU512	120	7549D	RU-01	225		
516047			VR-DU511	120	7549E	RU-01H	225		
516047A	RU-01H	225			7549F	RU-01	225		
516048			VR-DU511	120	7549G	RU-01H	225		
516048A	RU-01H	225			7550			VR-DU510	120
516048B	RU-01	225			7552			VR-DU509	120
516049			VR-DU511	120	7552A			VR-DU510	120
516053			VR-DU512	120	7552AB			VR-DU509	120
516054			VR-DU512	120	7552B			VR-DU510	120
516055			VR-DU512	120	7552C			VR-DU509	120
516057A	RU-01	225			7552D			VR-DU510	120
516057B	RU-01H	225			7553			VR-DU510	120
516058			VR-DU511	120	7554			VR-DU509	120
516058A	RU-01H	225			7554A			VR-DU510	120
516062			VR-DU511	120	7555			VR-DU510	120
516062A	RU-01H	225			7556			VR-DU510	120
516065			VR-DU512	120	7558A	RU-01	225		
581207A	RU-01	225			7558B	RU-01H	225		
581207B	RU-01H	225			7558C	RU-01	225		
581207C	RU-01	225			7560			VR-DU509	120
581207D	RU-01H	225			7560A			VR-DU510	120
581208A	RU-01	225			7560B			VR-DU509	120
581208B	RU-01H	225			7560C			VR-DU510	120
593009A	RU-01	225			7565			VR-DU509	120
593009B	RU-01H	225			7565A			VR-DU510	120
593009C	RU-01	225			7565AB			VR-DU509	120
71211302			VR-DU509	120	7565B			VR-DU510	120
71220002			VR-DU510	120	7565C			VR-DU509	120
71220102			VR-DU509	120	7565D			VR-DU510	120
71220402			VR-DU510	120	7565DE			VR-DU509	120
71220602			VR-DU509	120	7565E			VR-DU510	120
71220702			VR-DU510	120	7566			VR-DU509	120
71220902			VR-DU509	120	7566A			VR-DU510	120
71221002			VR-DU510	120	7566AB			VR-DU509	120
71223202			VR-DU509	120	7566B			VR-DU510	120
71223402			VR-DU510	120	7566C			VR-DU509	120
71223602			VR-DU509	120	7567			VR-DU510	120
71223802			VR-DU510	120	7567A			VR-DU509	120
71226602			VR-DU509	120	7567AB			VR-DU510	120
71227702			VR-DU510	120	7567B			VR-DU509	120
71270102			VR-DU509	120	7567C			VR-DU510	120
71270202			VR-DU510	120	7567D			VR-DU509	120
71270302			VR-DU509	120	7567DE			VR-DU510	120
71270402			VR-DU510	120	7567E			VR-DU509	120
71271002			VR-DU509	120	7568			VR-DU510	120
71273702			VR-DU510	120	7568A			VR-DU509	120
71427002			VR-DU509	120	7568AB			VR-DU510	120
71470302			VR-DU510	120	7568B			VR-DU509	120
71923002			VR-DU509	120	7568C			VR-DU510	120
7250			VR-DU509	120	7569A			VR-DU509	120
7258			VR-DU510	120	7569ABC			VR-DU510	120
7258C			VR-DU509	120	7569B			VR-DU509	120
750A	RU-01	225			7569C			VR-DU510	120
750B	RU-01H	225			7569D			VR-DU509	120
750C	RU-01	225			7570			VR-DU510	120
750D	RU-01H	225			7570A			VR-DU509	120
750E	RU-01	225			7570B			VR-DU509	120
750F	RU-01H	225			7571			VR-DU510	120
750G	RU-01	225			7572			VR-DU510	120
7522			VR-DU510	120	7575			VR-DU510	120
7526			VR-DU509	120	7575A	RU-01	225		
7526B			VR-DU510	120	7575B	RU-01H	225		
7526C			VR-DU509	120	7575C	RU-01	225		

CROSS REFERENCE
Voltage Regulator

CROSS REFERENCE
Rectifier

CROSS REFERENCE
Diode Trio

ALTERNATOR NO.
Reg & Rec

CROSS REFERENCE LIST

OEM Alternator No. → Mobiletron No.

OEM Alternator No.	Rectifier No.	Page	Regulator No.	Page	OEM Alternator No.	Rectifier No.	Page	Regulator No.	Page
7575D	RU-01H	225			A13R141			VR-DU510	120
7575E	RU-01	225			A13R152			VR-DU510	120
7576			VR-DU510	120	A13R154			VR-DU510	120
7576A	RU-01	225			A13R157			VR-DU510	120
7577			VR-DU510	120	A13R170			VR-DU510	120
7577A	RU-01	225			A13R171			VR-DU510	120
7577B	RU-01H	225			A13R177			VR-DU510	120
7577C	RU-01	225			A13R178			VR-DU510	120
7577D	RU-01H	225			A13R180			VR-DU510	120
7577E	RU-01	225			A13R184			VR-DU510	120
7577F	RU-01H	225			A13R186			VR-DU510	120
7577G	RU-01	225			A13R198			VR-DU510	120
7577H	RU-01H	225			A13R219			VR-DU510	120
7578			VR-DU510	120	A13R223			VR-DU510	120
7578A	RU-01	225			A13R265			VR-DU510	120
7578B	RU-01H	225			A14R29			VR-DU510	120
7578C	RU-01	225			A14R47			VR-DU510	120
7578D	RU-01H	225			VALEO(MOTOROLA)				
7579			VR-DU510	120	008-154-6708			VR-VW009	123
7580			VR-DU510	120	008-154-8702			VR-VW009	123
7581			VR-DU510	120	008-154-8902			VR-VW009	123
7581A	RU-01	225			0091545902			VR-VW010	123
7581B	RU-01H	225			026903015E	RT-10H	227	VR-VW005N	122
7581C	RU-01	225			026903015EV	RT-10H	227	VR-VW005N	122
7582			VR-DU510	120	026903015EX	RT-10H	227	VR-VW005N	122
7582A	RU-01	225			026903015EY	RT-10H	227	VR-VW005N	122
7584C	RU-01H	225			0269033015E	RT-10H	227		
7584D	RU-01	225			030903023AA			VR-VW010	123
7585			VR-DU510	120	030903023EV			VR-VW010	123
7585A	RU-01	225			030903023EX			VR-VW010	123
7585B	RU-01H	225			030903023FV			VR-VW010	123
7585C	RU-01	225			030903023FX			VR-VW010	123
7585D	RU-01H	225			030903023GV			VR-VW010	123
7586			VR-DU510	120	030903023GX			VR-VW010	123
7586A	RU-01	225			030903023QV			VR-VW010	123
7586B	RU-01H	225			030903023QX			VR-VW010	123
7586C	RU-01	225			049903119L	RT-10H	227	VR-VW005N	122
7586D	RU-01H	225			050903017H			VR-VW010	123
7586E	RU-01	225			068903031KV			VR-VW005N	122
7590			VR-DU510	120	068903031KX			VR-VW005N	122
7591			VR-DU510	120	068903171			VR-VW005N	122
7591A	RU-01	225			098603031KV	RT-10H	227		
7591B	RU-01H	225			098603171	RT-10H	227		
7591C	RU-01	225			098903031KX	RT-10H	227		
7591D	RU-01H	225			10-258			VR-VW007	122
7591E	RU-01	225			10-298			VR-VW006	122
7596			VR-DU510	120	10-763			VR-VW002	122
7596A	RU-01	225			10-764			VR-VW002	122
7596B	RU-01H	225			10-765			VR-VW002	122
7596C	RU-01	225			10-766			VR-VW002	122
7596D	RU-01H	225			10-767			VR-VW002	122
7596E	RU-01	225			10-769			VR-VW002	122
7596F	RU-01H	225			10-772			VR-VW002	122
7597			VR-DU510	120	110279	RT-24HD	228		
7597A	RU-01	225			110296	RT-24HD	228		
7597B	RU-01H	225			110309	RT-24HD	228		
7597C	RU-01	225			110555	RT-23HD	228		
7597D	RU-01H	225			2518017			VR-VW005N	122
7597E	RU-01	225			2518044			VR-VW009	123
7597F	RU-01H	225			2518046			VR-VW009	123
7700670275			VR-DU513	121	2521682			VR-VW005N	122
9AL2572K			VR-DU510	120	2523160			VR-VW002	122
9AL2582K			VR-DU510	120	2523207			VR-VW002	122
9AL2679K			VR-DU510	120	2541114			VR-VW005N	122
A12M1			VR-DU509	120	2541115			VR-VW005N	122
A12M10			VR-DU509	120	2541187			VR-VW005N	122
A12M18			VR-DU509	120	2541221	RT-10H	227	VR-VW005N	122
A12M2			VR-DU509	120	2541222	RT-10H	227	VR-VW005N	122
A12M3			VR-DU509	120	2541233			VR-VW005N	122
A12M6			VR-DU509	120	2541234			VR-VW005N	122
A12M7			VR-DU509	120	2541235			VR-VW005N	122
A13M11			VR-DU509	120	2541236			VR-VW005N	122
A13M13			VR-DU509	120	2541246			VR-VW010	123
A13M15			VR-DU509	120	2541297			VR-VW009	123
A13M16			VR-DU509	120	2541299			VR-VW010	123
A13M17			VR-DU509	120	2541301			VR-VW005N	122
A13M2			VR-DU509	120	2541305			VR-VW005N	122
A13M5			VR-DU509	120	2541321			VR-VW010	123
A13M7			VR-DU509	120	2541334			VR-VW005N	122
A13M8			VR-DU509	120	2541348			VR-VW010	123
A13N100			VR-DU510	120	2541355			VR-VW010	123
A13N102			VR-DU510	120	2541357			VR-VW010	123
A13N135			VR-DU510	120	2541360			VR-VW010	123
A13R115			VR-DU510	120	2541361			VR-VW010	123
A13R127			VR-DU509	120	2541362			VR-VW010	123

CROSS REFERENCE
Voltage Regulator

CROSS REFERENCE
Rectifier

CROSS REFERENCE
Diode Trio

ALTERNATOR NO.
Reg & Rec

CROSS REFERENCE LIST

OEM Alternator No. → Mobiletron No.

OEM Alternator No.	Rectifier No.	Page	Regulator No.	Page	OEM Alternator No.	Rectifier No.	Page	Regulator No.	Page
2541372			VR-VW005N	122	2541815			VR-VW010	123
2541391			VR-VW010	123	2541816			VR-VW010	123
2541395	RT-10H	227			2541817			VR-VW010	123
2541396	RT-10H	227	VR-VW005N	122	2541818			VR-VW010	123
2541402	RT-10H	227	VR-VW005N	122	2541821			VR-VW010	123
2541405			VR-VW010	123	290-300	RT-10H	227		
2541408			VR-VW010	123	290-301	RT-10H	227		
2541411			VR-VW010	123	290-302	RT-10H	227		
2541412			VR-VW010	123	290-303	RT-10H	227		
2541415			VR-VW010	123	290-304	RT-10H	227		
2541416			VR-VW010	123	290-306	RT-10H	227		
2541417			VR-VW010	123	290-307	RT-10H	227		
2541418			VR-VW010	123	290-308	RT-10H	227		
2541419			VR-VW010	123	290-309	RT-10H	227		
2541420			VR-VW010	123	290-310	RT-10H	227		
2541428			VR-VW005N	122	290-363	RT-10H	227		
2541429			VR-VW005N	122	290-365	RT-10H	227		
2541430			VR-VW005N	122	290-367	RT-10H	227		
2541431			VR-VW005N	122	290-369	RT-10H	227		
2541432			VR-VW005N	122	290-371	RT-10H	227		
2541438	RT-10H	227	VR-VW005N	122	290-373	RT-10H	227		
2541447			VR-VW010	123	290-375	RT-10H	227		
2541455			VR-VW010	123	2940300	RT-10H	227		
2541457			VR-VW010	123	2940301	RT-10H	227	VR-VW005N	122
2541458			VR-VW010	123	2940302	RT-10H	227	VR-VW005N	122
2541459			VR-VW010	123	2940303	RT-10H	227		
2541461			VR-VW010	123	2940304	RT-10H	227	VR-VW005N	122
2541475			VR-VW010	123	2940305	RT-10H	227	VR-VW005N	122
2541479			VR-VW005N	122	2940306	RT-10H	227	VR-VW005N	122
2541480			VR-VW005N	122	2940307	RT-10H	227	VR-VW005N	122
2541481			VR-VW005N	122	2940308	RT-10H	227	VR-VW005N	122
2541486			VR-VW010	123	2940309	RT-10H	227	VR-VW005N	122
2541494			VR-VW010	123	2940310	RT-10H	227	VR-VW005N	122
2541497			VR-VW005N	122	2940311	RT-10H	227	VR-VW005N	122
2541498			VR-VW005N	122	2940357			VR-VW002	122
2541499			VR-VW005N	122	2940361			VR-VW002	122
2541611			VR-VW010	123	2940363	RT-10H	227	VR-VW005N	122
2541612			VR-VW010	123	2940365	RT-10H	227	VR-VW005N	122
2541617			VR-VW010	123	2940367	RT-10H	227	VR-VW005N	122
2541626			VR-VW010	123	2940369	RT-10H	227	VR-VW005N	122
2541644			VR-VW010	123	2940371	RT-10H	227	VR-VW005N	122
2541646			VR-VW010	123	2940373	RT-10H	227	VR-VW005N	122
2541655			VR-VW010	123	2940375	RT-10H	227	VR-VW005N	122
2541658			VR-VW010	123	2940409			VR-VW005N	122
2541665			VR-VW010	123	2940782			VR-VW002	122
2541676			VR-VW010	123	2941388	RT-06H	226		
2541680			VR-VW010	123	433430	RT-21H	227		
2541682			VR-VW005N	122	433437	RT-21H	227		
2541683			VR-VW010	123	433453	RT-21H	227		
2541694			VR-VW010	123	436112			VR-VW005N	122
2541698			VR-VW010	123	436114			VR-VW005N	122
2541699			VR-VW010	123	436117			VR-VW005N	122
2541703			VR-VW010	123	436132			VR-VW005N	122
2541711			VR-VW010	123	436134			VR-VW005N	122
2541719			VR-VW010	123	436147			VR-VW005N	122
2541724			VR-VW010	123	436191	RT-10H	227	VR-VW005N	122
2541726			VR-VW010	123	436192	RT-10H	227	VR-VW005N	122
2541731			VR-VW010	123	436193	RT-10H	227	VR-VW005N	122
2541733			VR-VW010	123	436220			VR-VW005N	122
2541734			VR-VW010	123	436258			VR-VW010	123
2541736			VR-VW010	123	436260			VR-VW010	123
2541738			VR-VW010	123	436261			VR-VW010	123
2541739			VR-VW010	123	436294			VR-VW005N	122
2541740			VR-VW010	123	436296	RT-10H	227	VR-VW005N	122
2541741			VR-VW010	123	436318	RT-21H	227		
2541747			VR-VW010	123	436330			VR-VW005N	122
2541758			VR-VW010	123	436331			VR-VW005N	122
2541759			VR-VW010	123	436332			VR-VW005N	122
2541760			VR-VW010	123	436333			VR-VW005N	122
2541763			VR-VW010	123	436334			VR-VW005N	122
2541764			VR-VW010	123	436336			VR-VW010	123
2541765			VR-VW010	123	436338			VR-VW010	123
2541767			VR-VW010	123	436339			VR-VW010	123
2541775			VR-VW010	123	436340			VR-VW010	123
2541776			VR-VW010	123	436345			VR-VW010	123
2541784			VR-VW010	123	436346			VR-VW010	123
2541785			VR-VW010	123	436361			VR-VW010	123
2541786			VR-VW010	123	436364			VR-VW010	123
2541793			VR-VW010	123	436368	RT-10H	227	VR-VW005N	122
2541794			VR-VW010	123	436369	RT-10H	227	VR-VW005N	122
2541799			VR-VW010	123	436370	RT-10H	227	VR-VW005N	122
2541801			VR-VW010	123	436379			VR-VW010	123
2541802			VR-VW010	123	436380			VR-VW010	123
2541812			VR-VW010	123	436385			VR-VW010	123
2541814			VR-VW010	123	436386			VR-VW010	123

CROSS REFERENCE
Voltage Regulator

CROSS REFERENCE
Rectifier

CROSS REFERENCE
Diode Trio

ALTERNATOR NO.
Reg & Rec

CROSS REFERENCE LIST

OEM Alternator No. → Mobiletron No.

OEM Alternator No.	Rectifier No.	Page	Regulator No.	Page	OEM Alternator No.	Rectifier No.	Page	Regulator No.	Page
436388			VR-VW010	123	9AR2572K	RT-08H	227		
436389			VR-VW010	123	9AR2592K	RT-08H	227		
436398			VR-VW005N	122	9AR2594G	RT-05H	226		
436399	RT-10H	227	VR-VW005N	122	9AR2596K	RT-07H	227		
436400	RT-10H	227	VR-VW005N	122	9AR2600G	RT-08H	227		
436404			VR-VW005N	122	9AR2602F	RT-05H	226		
436405			VR-VW005N	122	9AR2603F	RT-05H	226		
510-015			VR-VW002	122	9AR2604L	RT-05H	226		
510-031			VR-VW002	122	9AR2605L	RT-02H	226		
510-054			VR-VW002	122	9AR2610G	RT-02H	226		
510-123			VR-VW002	122	9AR2611F	RT-05H	226		
510146	RT-21H	227			9AR2612G	RT-05H	226		
510-146			VR-VW002	122	9AR2613F	RT-05H	226		
510147	RT-21H	227			9AR2614G	RT-05H	226		
510-148			VR-VW002	122	9AR2622L	RT-02H	226		
510-205			VR-VW002	122	9AR2627G	RT-02H	226		
510-246			VR-VW002	122	9AR2630K	RT-05H	226		
510-270			VR-VW002	122	9AR2633G	RT-12H	227		
510-283			VR-VW002	122	9AR2636G	RT-02H	226		
510-296			VR-VW002	122	9AR2637P	RT-05H	226		
510-330			VR-VW002	122	9AR2638P	RT-09H	227	VR-VW002	122
510-357			VR-VW002	122	9AR2650D	RT-02H	226		
510-401			VR-VW002	122	9AR2651D	RT-02H	226		
510-412			VR-VW002	122	9AR2652F	RT-02H	226		
510-453			VR-VW002	122	9AR2653F	RT-02H	226		
510-455			VR-VW002	122	9AR2654G	RT-02H	226		
510-465			VR-VW002	122	9AR2655G	RT-02H	226		
8SC3014U			VR-VW006	122	9AR2662F	RT-12H	227		
91545902			VR-VW010	123	9AR2663K	RT-09H	227		
9AI2617K	RT-09H	227			9AR2664F	RT-12H	227		
9AL2502K	RT-08H	227			9AR2672P	RT-09H	227	VR-VW002	122
9AL2505P	RT-08H	227			9AR2673K	RT-09H	227		
9AL2538K	RT-08H	227			9AR2682F	RT-01H	226		
9AL2559G	RT-08H	227			9AR2683G	RT-02H	226	VR-VW003	122
9AL2572K	RT-08H	227			9AR2684P	RT-05H	226		
9AL2577G	RT-08H	227			9AR2687G			VR-VW003	122
9AL2583K	RT-08H	227			9AR2690P	RT-09H	227		
9AL2584G	RT-08H	227			9AR2691G	RT-09H	227		
9AL2589K	RT-08H	227			9AR2692G	RT-09H	227		
9AL2590K	RT-08H	227			9AR2693P	RT-09H	227		
9AL2591K	RT-08H	227			9AR2694P	RT-09H	227	VR-VW002	122
9AL2592K	RT-08H	227			9AR2697D			VR-VW003	122
9AL2593K	RT-08H	227			9AR2698F			VR-VW003	122
9AL2600G	RT-08H	227			9AR2699G			VR-VW003	122
9AL2615G	RT-05H	226			9AR2700G			VR-VW003	122
9AL2628P	RT-08H	227			9AR2701D			VR-VW003	122
9AL2633G	RT-12H	227			9AR2702			VR-VW003	122
9AL2666F	RT-12H	227			9AR2703F			VR-VW003	122
9AL2688K	RT-05H	226			9AR2704F			VR-VW003	122
9AL2689K	RT-05H	226			9AR2705G			VR-VW003	122
9AL2774G	RT-12H	227			9AR2706G			VR-VW003	122
9AL2834K	RT-08H	227			9AR2707G			VR-VW003	122
9AL2873K	RT-08H	227			9AR2708G			VR-VW003	122
9AL2937K	RT-08H	227			9AR2709L	RT-06H	226		
9AL2939K	RT-08H	227			9AR2714F	RT-07H	227		
9AL2969F	RT-01H	226			9AR2715F	RT-09H	227		
9AL2977			VR-VW005N	122	9AR2716G	RT-01H	226		
9AR11711	RT-05H	226			9AR2717G	RT-01H	226		
9AR2500K	RT-06H	226	VR-VW002	122	9AR2718G	RT-01H	226	VR-VW003	122
9AR2501K	RT-07H	227			9AR2719G	RT-01H	226	VR-VW003	122
9AR2506K	RT-06H	226	VR-VW002	122	9AR2725F	RT-05H	226		
9AR2511F	RT-06H	226			9AR2726G			VR-VW003	122
9AR2512P	RT-05H	226	VR-VW002	122	9AR2727G			VR-VW003	122
9AR2515K	RT-06H	226			9AR2729G	RT-12H	227	VR-VW003	122
9AR2516F	RT-06H	226			9AR27459K02	RT-05H	226		
9AR2517K	RT-06H	226			9AR2748G	RT-12H	227		
9AR2518F	RT-06H	226			9AR2749G	RT-01H	226		
9AR2519F	RT-06H	226			9AR2750G	RT-01H	226	VR-VW003	122
9AR2520K	RT-06H	226	VR-VW002	122	9AR2751G	RT-01H	226	VR-VW003	122
9AR2524F	RT-06H	226			9AR2755P	RT-09H	227	VR-VW002	122
9AR2525K	RT-06H	226			9AR2756F	RT-06H	226		
9AR2526F	RT-02H	226			9AR2759			VR-VW002	122
9AR2527K	RT-02H	226			9AR2759K	RT-05H	226		
9AR2528F	RT-02H	226			9AR2759K0	RT-05H	226		
9AR2530K	RT-05H	226			9AR2759K01	RT-05H	226		
9AR2533P	RT-05H	226	VR-VW002	122	9AR2759K02	RT-05H	226		
9AR2539K	RT-05H	226	VR-VW002	122	9AR2784K	RT-05H	226		
9AR2545K	RT-05H	226			9AR2785K	RT-05H	226		
9AR2556K	RT-09H	227			9AR2786K	RT-05H	226		
9AR2559G	RT-08H	227			9AR2792G			VR-VW003	122
9AR2561K	RT-05H	226	VR-VW002	122	9AR2794K	RT-09H	227		
9AR2562K	RT-05H	226			9AR2799G	RT-01H	226		
9AR2566K	RT-09H	227			9AR2805G			VR-VW002	122
9AR2569G	RT-05H	226			9AR2810L	RT-07H	227		
9AR2570G	RT-05H	226			9AR2814D	RT-01H	226		

CROSS REFERENCE
Voltage Regulator

CROSS REFERENCE
Rectifier

CROSS REFERENCE
Diode Trio

ALTERNATOR NO.
Reg & Rec

CROSS REFERENCE LIST

OEM Alternator No. → Mobiletron No.

OEM Alternator No.	Rectifier No.	Page	Regulator No.	Page	OEM Alternator No.	Rectifier No.	Page	Regulator No.	Page
9AR2814G			VR-VW003	122	9AR3835L	RT-04H	226		
9AR2815K	RT-09H	227			9AR3949K	RT-09H	227		
9AR2819G			VR-VW003	122	9AR3949K0	RT-09H	227		
9AR2820G			VR-VW003	122	9AR3949K01	RT-09H	227		
9AR2821G	RT-01H	226	VR-VW003	122	9AR3949K02	RT-09H	227		
9AR2828G	RT-03H	226			9AR5001K	RT-09H	227	VR-VW002	122
9AR2829G	RT-12H	227			9AR5010F	RT-05H	226		
9AR2830L			VR-VW002	122	9AR5010K	RT-05H	226		
9AR2833K	RT-05H	226			9AR5028K	RT-05H	226		
9AR2834K	RT-08H	227			9AR5028K0	RT-05H	226		
9AR2838L			VR-VW002	122	9AR5028K01	RT-05H	226		
9AR2839G			VR-VW003	122	9AR5028K02	RT-05H	226		
9AR2840D			VR-VW003	122	9AR5036L	RT-06H	226		
9AR2841D			VR-VW003	122	9AR5037L	RT-07H	227	VR-VW002	122
9AR2842G			VR-VW003	122	9AR5039L			VR-VW002	122
9AR2843G			VR-VW003	122	9AR5040K	RT-05H	226		
9AR2846K	RT-05H	226			9AR5044K	RT-05H	226	VR-VW005N	122
9AR2847F	RT-12H	227	VR-VW003	122	9AR5046G	RT-05H	226	VR-VW005N	122
9AR2851K	RT-05H	226			9AR5062K	RT-09H	227		
9AR2852K	RT-05H	226			9AR5070K	RT-05H	226		
9AR2853K	RT-05H	226			9AR5081K	RT-05H	226	VR-VW005N	122
9AR2856K	RT-09H	227			9AR5082G	RT-05H	226	VR-VW005N	122
9AR2861K	RT-05H	226			9AR5083G	RT-05H	226	VR-VW005N	122
9AR2862			VR-VW002	122	9AR5084L	RT-05H	226	VR-VW005N	122
9AR2862K	RT-05H	226			9AR5085L	RT-05H	226	VR-VW005N	122
9AR2867L			VR-VW002	122	9AR5086L	RT-05H	226	VR-VW005N	122
9AR2871F	RT-03H	226			9AR5087K	RT-05H	226	VR-VW005N	122
9AR2871G	RT-12H	227			9AR5088L	RT-05H	226	VR-VW005N	122
9AR2875G	RT-03H	226			9AR5089G	RT-05H	226	VR-VW005N	122
9AR2876D			VR-VW003	122	9AR5090L	RT-05H	226	VR-VW005N	122
9AR2877F			VR-VW003	122	9AR5092K	RT-05H	226		
9AR2878G			VR-VW003	122	9AR5092K0	RT-05H	226		
9AR2880K			VR-VW003	122	9AR5092K01	RT-05H	226		
9AR2882F	RT-01H	226	VR-VW003	122	9AR5092K02	RT-05H	226		
9AR2883G			VR-VW003	122	9AR5097P	RT-09H	227		
9AR2884L	RT-06H	226			9AR5098F1	RT-02H	226		
9AR2887G	RT-01H	226			9AR5099			VR-VW005N	122
9AR2889F			VR-VW003	122	9AR5099L	RT-05H	226	VR-VW005N	122
9AR2890G			VR-VW003	122	9AR5100G	RT-05H	226	VR-VW005N	122
9AR2895F			VR-VW003	122	9AR5101K	RT-05H	226	VR-VW005N	122
9AR2895F02			VR-VW003	122	9AR5107L	RT-05H	226		
9AR2895F03			VR-VW003	122	9AR5108K	RT-05H	226		
9AR2897L	RT-06H	226	VR-VW002	122	9AR6035L	RT-04H	226		
9AR2904L	RT-09H	227			9AR6053L	RT-05H	226		
9AR2909P	RT-09H	227			9AR6057L	RT-04H	226		
9AR2913D			VR-VW003	122	9AR6058L	RT-05H	226		
9AR2914D			VR-VW003	122	9AR6093K	RT-09H	227		
9AR2915F			VR-VW003	122	9AR6095G	RT-07H	227		
9AR2916F			VR-VW003	122	9ASR5043P			VR-VW002	122
9AR2917G			VR-VW003	122	9BB2KA2A01			VR-VW002	122
9AR2918G			VR-VW003	122	9BB2KB2A02			VR-VW002	122
9AR2919P	RT-06H	226			9BB2KB2A06			VR-VW002	122
9AR2920P	RT-06H	226			9BB2KB2A07			VR-VW002	122
9AR2929G	RT-05H	226	VR-VW003	122	9BE2KA2A14			VR-VW002	122
9AR2930G	RT-09H	227			9BE2KB2A06			VR-VW002	122
9AR2938T			VR-VW002	122	9BE2KB2A07			VR-VW002	122
9AR2941L0	RT-09H	227			9BE2KB2A08			VR-VW002	122
9AR2941L02	RT-09H	227			9BE2KB2A15			VR-VW002	122
9AR2941L03	RT-09H	227			9BE2KC2A32			VR-VW002	122
9AR2944K	RT-05H	226			9BE2KD2A40			VR-VW002	122
9AR2960F			VR-VW003	122	9BE2NA2A21			VR-VW002	122
9AR29631	RT-05H	226			9BE2NB2A38			VR-VW002	122
9AR2963L	RT-05H	226			9BE2NE2A41			VR-VW002	122
9AR2964K	RT-09H	227			9FB2KA2A03			VR-VW002	122
9AR2970K	RT-05H	226	VR-VW005N	122	9FB2KB2A04			VR-VW002	122
9AR2971G	RT-05H	226	VR-VW005N	122	9FB2KB2A06			VR-VW002	122
9AR2972G	RT-05H	226	VR-VW005N	122	9FD2LD2A07			VR-VW002	122
9AR2973L	RT-05H	226	VR-VW005N	122	9FD2KB2A12			VR-VW002	122
9AR2974L	RT-05H	226	VR-VW005N	122	9FD2KC2A35			VR-VW002	122
9AR2975L	RT-05H	226	VR-VW005N	122	9FD2LD2A07			VR-VW002	122
9AR2976K	RT-05H	226	VR-VW005N	122	9FD2LE2A13			VR-VW002	122
9AR2977L	RT-05H	226	VR-VW005N	122	9FD2NA2A19			VR-VW002	122
9AR2978F			VR-VW003	122	9FD2NC2A24			VR-VW002	122
9AR2981L	RT-05H	226			9FD2ND2A34			VR-VW002	122
9AR2982L	RT-05H	226			9FD2ND2A42			VR-VW002	122
9AR2990P	RT-09H	227	VR-VW002	122	9FD2NE2A33			VR-VW002	122
9AR2992P			VR-VW002	122	9FD2NE2A43			VR-VW002	122
9AR2995R	RT-09H	227			9FD2NF2A37			VR-VW002	122
9AR2997K	RT-06H	226			9FD2NF2A44			VR-VW002	122
9AR2998K	RT-09H	227			9FD2NG2A39			VR-VW002	122
9AR3599G	RT-07H	227			9FD2PA2A16			VR-VW002	122
9AR3620G	RT-09H	227			9FE2KA2A11			VR-VW002	122
9AR3649G	RT-09H	227			9FE2KA2A18			VR-VW002	122
9AR3802L	RT-05H	226			9FE2KB2A07			VR-VW002	122
9AR3825L	RT-05H	226			9FE2KB2A08			VR-VW002	122

CROSS REFERENCE
Voltage Regulator

CROSS REFERENCE
Rectifier

CROSS REFERENCE
Diode Trio

ALTERNATOR NO.
Reg & Rec

CROSS REFERENCE LIST

OEM Alternator No. → Mobiletron No.

OEM Alternator No.	Rectifier No.	Page	Regulator No.	Page	OEM Alternator No.	Rectifier No.	Page	Regulator No.	Page
9FE2LD2A07			VR-VW002	122	A13VI126			VR-VW010	123
9FE2LD2A08			VR-VW002	122	A13VI132			VR-VW010	123
9FF2LD2A10			VR-VW002	122	A13VI137			VR-VW010	123
9GD2NA2A25			VR-VW002	122	A13VI138			VR-VW010	123
A11VI10			VR-VW010	123	A13VI140			VR-VW010	123
A11VI11			VR-VW010	123	A13VI142			VR-VW010	123
A11VI15			VR-VW010	123	A13VI27			VR-VW010	123
A11VI17			VR-VW010	123	A13VI33			VR-VW010	123
A11VI18			VR-VW010	123	A13VI36			VR-VW010	123
A11VI19			VR-VW010	123	A13VI37			VR-VW010	123
A11VI20			VR-VW010	123	A13VI38			VR-VW010	123
A11VI22			VR-VW010	123	A13VI39			VR-VW010	123
A11VI23			VR-VW010	123	A13VI40			VR-VW010	123
A11VI24			VR-VW010	123	A13VI41			VR-VW010	123
A11VI25			VR-VW010	123	A13VI42			VR-VW010	123
A11VI32			VR-VW010	123	A13VI43			VR-VW010	123
A11VI33			VR-VW010	123	A13VI44			VR-VW010	123
A11VI35			VR-VW010	123	A13VI48			VR-VW010	123
A11VI36			VR-VW010	123	A13VI49			VR-VW010	123
A11VI37			VR-VW010	123	A13VI51			VR-VW010	123
A11VI38			VR-VW010	123	A13VI53			VR-VW010	123
A11VI39			VR-VW010	123	A13VI54			VR-VW010	123
A11VI40			VR-VW010	123	A13VI58			VR-VW010	123
A11VI42			VR-VW010	123	A13VI59			VR-VW010	123
A11VI43			VR-VW010	123	A13VI60			VR-VW010	123
A11VI44			VR-VW010	123	A13VI63			VR-VW010	123
A11VI45			VR-VW010	123	A13VI67			VR-VW010	123
A11VI46			VR-VW010	123	A13VI68			VR-VW010	123
A11VI47			VR-VW010	123	A13VI69			VR-VW010	123
A11VI48			VR-VW010	123	A13VI70			VR-VW010	123
A11VI49			VR-VW010	123	A13VI71			VR-VW010	123
A11VI50			VR-VW010	123	A13VI74			VR-VW010	123
A11VI51			VR-VW010	123	A13VI75			VR-VW010	123
A11VI52			VR-VW010	123	A13VI76			VR-VW010	123
A11VI53			VR-VW010	123	A13VI79			VR-VW010	123
A11VI55			VR-VW010	123	A13VI81			VR-VW010	123
A11VI56			VR-VW010	123	A13VI83			VR-VW010	123
A11VI57			VR-VW010	123	A13VI84			VR-VW010	123
A11VI58			VR-VW010	123	A13VI85			VR-VW010	123
A11VI60			VR-VW010	123	A13VI86			VR-VW010	123
A11VI62			VR-VW010	123	A13VI87			VR-VW010	123
A11VI63			VR-VW010	123	A13VI88			VR-VW010	123
A11VI65			VR-VW010	123	A13VI94			VR-VW010	123
A11VI66			VR-VW010	123	A13VI95			VR-VW010	123
A11VI91			VR-VW010	123	A13VI96			VR-VW010	123
A13E02	RT-10H	227			A13VI99			VR-VW010	123
A13E03	RT-10H	227	VR-VW005N	122	A14V01			VR-VW005N	122
A13E04	RT-10H	227	VR-VW005N	122	A14V02			VR-VW005N	122
A13E05	RT-10H	227	VR-VW005N	122	A14V03			VR-VW005N	122
A13E06	RT-10H	227	VR-VW005N	122	A14V04			VR-VW005N	122
A13E07	RT-10H	227	VR-VW005N	122	A14V05			VR-VW005N	122
A13E08	RT-10H	227	VR-VW005N	122	A14V07			VR-VW005N	122
A13E09	RT-10H	227	VR-VW005N	122	A14V08			VR-VW005N	122
A13E10	RT-10H	227	VR-VW005N	122	A14V09			VR-VW005N	122
A13E11	RT-10H	227	VR-VW005N	122	A14V10			VR-VW005N	122
A13E12	RT-10H	227	VR-VW005N	122	A14V11			VR-VW005N	122
A13E13	RT-10H	227	VR-VW005N	122	A14V12			VR-VW005N	122
A13E19			VR-VW005N	122	A14V13			VR-VW005N	122
A13E21	RT-10H	227	VR-VW005N	122	A14V14			VR-VW005N	122
A13E22	RT-10H	227	VR-VW005N	122	A14V15			VR-VW005N	122
A13E23			VR-VW005N	122	A14V16			VR-VW005N	122
A13E24			VR-VW005N	122	A14V17			VR-VW005N	122
A13E25			VR-VW005N	122	A14V18			VR-VW005N	122
A13E26			VR-VW005N	122	A14V19			VR-VW005N	122
A13E43	RT-10H	227			A14VI10			VR-VW010	123
A13E47	RT-10H	227	VR-VW005N	122	A14VI11			VR-VW010	123
A13E48	RT-10H	227	VR-VW005N	122	A14VI13			VR-VW010	123
A13E49	RT-10H	227			A14VI14			VR-VW010	123
A13E54	RT-10H	227			VALEO(PARIS RHONE)				
A13E58	RT-10H	227			03C-903-023B			VR-PR2292H	127
A13V02			VR-VW009	123	03C-903-025D			VR-PR2292H	127
A13V05			VR-VW009	123	04E-903-023N			VR-PR2292H	127
A13V07			VR-VW009	123	06J-903-023C			VR-PR2292H	127
A13VI10			VR-VW010	123	0-986-045-031			VR-PR2206	127
A13VI100			VR-VW010	123	10246634			VR-PR1935	127
A13VI101			VR-VW010	123	10295859			VR-PR6366	130
A13VI102			VR-VW010	123	11011			VR-PR5023	129
A13VI108			VR-VW010	123	11012			VR-PR5011	129
A13VI109			VR-VW010	123	11013			VR-PR5011	129
A13VI113			VR-VW010	123	11015	RP-43	233		
A13VI114			VR-VW010	123	11016			VR-PR5011	129
A13VI121			VR-VW010	123	11020	RP-43	233		
A13VI123			VR-VW010	123	13866			VR-PR2765	128
A13VI124			VR-VW010	123	13945			VR-PR3389	128
A13VI125			VR-VW010	123	1541683	RP-14	231		

CROSS REFERENCE
Voltage Regulator

CROSS REFERENCE
Rectifier

CROSS REFERENCE
Diode Trio

ALTERNATOR NO.
Reg & Rec

CROSS REFERENCE LIST

OEM Alternator No. → Mobiletron No.

OEM Alternator No.	Rectifier No.	Page	Regulator No.	Page	OEM Alternator No.	Rectifier No.	Page	Regulator No.	Page
1541696	RP-14	231			37300-37405	RP-43	233		
1541697	RP-14	231			37300-39400			VR-PR5011	129
2098216			VR-PR123	124	37300-39435			VR-PR5011	129
2098482			VR-PR123	124	37300-39450			VR-PR5011	129
2101368			VR-PR2700	128	436259	RP-13	231		
2101823			VR-PR132B	125	436261	RP-13	231		
2102052			VR-PR3729A	129	436336	RP-13	231		
2102159			VR-PR123	124	436340	RP-13	231		
2102160			VR-PR123	124	436352			VR-PR132B	125
2102746			VR-PR2700	128	436362	RP-13	231		
2104355			VR-PR2700	128	436381	RP-14	231		
2104905			VR-PR2700	128	436386	RP-14	231		
2180619			VR-PR3729A	129	436387	RP-14	231		
2180620			VR-PR3729A	129	436389	RP-14	231		
2181757			VR-PR132B	125	436712			VR-PR1620H	126
2181758			VR-PR132B	125	436742			VR-PR1620H	126
2181759			VR-PR132B	125	436748			VR-PR1620H	126
2181760			VR-PR132B	125	436750			VR-PR1620H	126
2181991			VR-PR3729A	129	437112			VR-PR1620H	126
23515	RP-40H	233			437119			VR-PR1620H	126
2541168			VR-PR3729A	129	437168			VR-PR1620H	126
2541199			VR-PR3729A	129	437173			VR-PR2292H	127
2541348	RP-14	231			437183			VR-PR1620H	126
2541356	RP-13	231			437196			VR-PR1620H	126
2541360	RP-13	231			437197			VR-PR1620H	126
2541361	RP-13	231			437200			VR-PR1620H	126
2541362	RP-13	231			437306			VR-PR1620H	126
2541455	RP-13	231			437323			VR-PR1620H	126
2541473	RP-14	231			437347			VR-PR1620H	126
2541644	RP-14	231			437353			VR-PR1620H	126
2541656	RP-14	231			437358			VR-PR2292H	127
2541660			VR-PR132B	125	437408			VR-PR1620H	126
2541678	RP-14	231	VR-PR1669	126	437488	RP-43	233		
2541679			VR-PR1669	126	439215			VR-PR1620H	126
2541680	RP-14	231			439218			VR-PR6366	130
2541946			VR-PR1620H	126	439230			VR-PR1620H	126
2541947			VR-PR1620H	126	439260			VR-PR2292H	127
2541953			VR-PR1620H	126	439266			VR-PR1620H	126
2541954			VR-PR1620H	126	439280			VR-PR1620H	126
2541980			VR-PR1620H	126	439281			VR-PR1620H	126
2542227			VR-PR2292H	127	439284			VR-PR1620H	126
2542233C			VR-PR2292H	127	439295	RP-43	233	VR-PR3389	128
2542234			VR-PR2292H	127	439302			VR-PR1620H	126
2542252			VR-PR1620H	126	5010306710	RP-40H	233		
2542270			VR-PR2299H	127	603030256	RP-39H	233		
2542275			VR-PR1620H	126	71635102	RP-03	229		
2542302			VR-PR1620H	126	71635202	RP-04	229		
2542310	RP-40H	233			71635502	RP-04	229		
2542322			VR-PR1620H	126	71635602	RP-03	229		
2542324			VR-PR2292H	127	71635702	RP-04R	230		
2542325			VR-PR1620H	126	71635802	RP-04	229		
2542326			VR-PR1620H	126	71635902	RP-03	229		
2542327			VR-PR1620H	126	71636002	RP-04	229		
2542354			VR-PR1620H	126	71636102	RP-03	229		
2542414A			VR-PR3534	128	71636202	RP-04R	230		
2542433			VR-PR3430	128	71636302	RP-04R	230		
2542433A	RP-38	233			71636402	RP-04R	230		
2542445A			VR-PR1935	127	71636802	RP-04R	230		
2542454A			VR-PR2765	128	71636902	RP-04R	230		
2542464			VR-PR1620H	126	71645002	RP-04	229		
2542466			VR-PR2299H	127	71650002	RP-03	229		
2542479			VR-PR3430	128	71650202	RP-04	229		
2542480			VR-PR1620H	126	71650402	RP-03	229		
2542485A	RP-39H	233	VR-PR3529	128	71650802	RP-03	229		
2542489			VR-PR3534	128	71651202	RP-04	229		
2542489A			VR-PR3534	128	71651302	RP-04	229		
2542493			VR-PR3430	128	71651502	RP-04R	230		
2542495			VR-PR1620H	126	71651602	RP-04	229		
2542500			VR-PR6603H	130	71651802	RP-03	229		
2542551			VR-PR1620H	126	71651902	RP-03	229	VR-PR1000H	124
2542552			VR-PR1620H	126	71652002	RP-04R	230		
2542553			VR-PR1620H	126	71652102	RP-04R	230		
2542564			VR-PR3534	128	71652202	RP-04	229		
2542645			VR-PR1620H	126	71652302	RP-04R	230		
2542691			VR-PR1620H	126	71652402	RP-03	229	VR-PR1000H	124
2542812			VR-PR2206	127	71652602	RP-03	229	VR-PR1000H	124
2542812A			VR-PR2206	127	71652703	RP-04R	230		
2542826			VR-PR2206	127	71653102	RP-04R	230		
2542826A			VR-PR2206	127	71653202	RP-04R	230		
2655010	RP-43	233			71655002	RP-04	229		
2655023			VR-PR5023	129	71655102	RP-04	229		
2655516	RP-43	233			71655302	RP-04	229		
37300-22650			VR-PR5023	129	71655502	RP-04	229		
37300-37250			VR-PR3389	128	71770002	RP-04	229		
37300-37400	RP-43	233			71770102	RP-03	229		

CROSS REFERENCE
Voltage Regulator

CROSS REFERENCE
Rectifier

CROSS REFERENCE
Diode Trio

ALTERNATOR NO.
Reg & Rec

CROSS REFERENCE LIST

OEM Alternator No. → Mobiletron No.

OEM Alternator No.	Rectifier No.	Page	Regulator No.	Page	OEM Alternator No.	Rectifier No.	Page	Regulator No.	Page
71770202	RP-03	229			A12R14	RP-10	231		
9642879480	RP-39H	233	VR-PR3529	128	A12R16	RP-10	231		
A0002655011			VR-PR5011	129	A12R17	RP-10	231		
A0002655023			VR-PR5023	129	A12R19	RP-10	231		
A0002655045			VR-PR5011	129	A12R2	RP-10	231		
A0002655438			VR-PR5011	129	A12R20	RP-10	231		
A0002655516	RP-43	233			A12R21	RP-10	231		
A11M10	RP-11	231			A12R22	RP-10	231	VR-PR2000H	127
A11M14	RP-11	231			A12R23	RP-10	231		
A11R1	RP-10	231			A12R24	RP-10	231		
A11R2	RP-10	231			A12R25	RP-10	231		
A11R3	RP-10	231			A12R26	RP-10	231		
A11R4	RP-10	231			A12R27	RP-10	231		
A11VI10	RP-48	233			A12R28	RP-10	231		
A11VI104	RP-17	232			A12R3	RP-10	231		
A11VI105	RP-17	232			A12R30	RP-10	231		
A11VI106	RP-17	232			A12R31	RP-10	231		
A11VI107	RP-17	232			A12R32	RP-10	231		
A11VI11	RP-15	231			A12R33	RP-10	231	VR-PR2000H	127
A11VI110	RP-48	233	VR-PR1620H	126	A12R34	RP-10	231		
A11VI111	RP-48	233	VR-PR1620H	126	A12R35T			VR-PR127B	125
A11VI13	RP-17	232			A12R36	RP-10	231		
A11VI131	RP-17	232			A12R37	RP-10	231		
A11VI15	RP-13	231			A12R38	RP-10	231	VR-PR130	125
A11VI16	RP-13	231			A12R4	RP-10	231		
A11VI165			VR-PR002H	124	A12R42	RP-10	231		
A11VI17	RP-13	231			A12R43	RP-10	231		
A11VI18	RP-13	231			A12R44	RP-10	231		
A11VI184			VR-PR002H	124	A12R45	RP-10	231		
A11VI209			VR-PR002H	124	A12R46	RP-10	231	VR-PR130	125
A11VI212			VR-PR002H	124	A12R47	RP-10	231		
A11VI216			VR-PR002H	124	A12R48	RP-10	231		
A11VI217			VR-PR002H	124	A12R50	RP-10	231		
A11VI218			VR-PR002H	124	A12R52	RP-10	231	VR-PR2000H	127
A11VI224			VR-PR002H	124	A12R53	RP-10	231		
A11VI225			VR-PR002H	124	A12R54	RP-10	231		
A11VI227			VR-PR002H	124	A12R55	RP-10	231		
A11VI23	RP-15	231			A12R56	RP-10	231		
A11VI24	RP-15	231			A12R59	RP-10	231		
A11VI25	RP-15	231			A12R6	RP-10	231		
A11VI254			VR-PR002H	124	A12R8	RP-10	231		
A11VI28			VR-PR1667	126	A12R9	RP-10	231		
A11VI29	RP-17	232			A13N10			VR-PR126	124
A11VI30	RP-17	232			A13N103	RP-03	229		
A11VI31	RP-17	232	VR-PR1667	126	A13N104	RP-01	229	VR-PR1000H	124
A11VI32	RP-15	231			A13N106	RP-03	229	VR-PR1000H	124
A11VI33	RP-15	231			A13N107	RP-08	230	VR-PR1000H	124
A11VI37	RP-15	231			A13N108	RP-08	230	VR-PR1000H	124
A11VI40	RP-15	231			A13N109	RP-04	229		
A11VI43	RP-15	231			A13N11	RP-06H	230	VR-PR128B	125
A11VI44	RP-15	231			A13N110	RP-01	229	VR-PR1000H	124
A11VI45	RP-15	231			A13N112	RP-08	230		
A11VI47	RP-13	231			A13N113	RP-03	229	VR-PR1000H	124
A11VI48	RP-13	231			A13N114	RP-03	229		
A11VI54	RP-22	232			A13N116	RP-03	229	VR-PR1000H	124
A11VI59	RP-17	232			A13N117	RP-08	230	VR-PR1000H	124
A11VI61	RP-17	232			A13N119	RP-08	230	VR-PR1000H	124
A11VI76	RP-22	232			A13N12	RP-01	229	VR-PR1000H	124
A11VI77	RP-22	232			A13N120	RP-03	229	VR-PR1000H	124
A11VI79	RP-22	232	VR-PR002H	124	A13N121	RP-01	229	VR-PR1000H	124
A11VI85			VR-PR002H	124	A13N123	RP-04H	229		
A11VI87	RP-48	233	VR-PR1620H	126	A13N124	RP-03	229	VR-PR1000H	124
A11VI88	RP-48	233	VR-PR1620H	126	A13N125	RP-03	229		
A11VI92			VR-PR002H	124	A13N126	RP-03	229	VR-PR1000H	124
A11VI93			VR-PR002H	124	A13N127	RP-03	229		
A11VI94	RP-48	233	VR-PR1620H	126	A13N128	RP-03	229		
A11VI95	RP-48	233			A13N129	RP-04	229		
A11VI96			VR-PR002H	124	A13N13	RP-01	229	VR-PR1000H	124
A11VI98	RP-48	233	VR-PR1620H	126	A13N130	RP-04HR	229		
A12M1	RP-11	231			A13N133	RP-06H	230		
A12M10	RP-11	231			A13N135	RP-06H	230		
A12M11			VR-PR123	124	A13N136	RP-01	229		
A12M16			VR-PR123	124	A13N137	RP-01	229	VR-PR1000H	124
A12M17			VR-PR123	124	A13N139	RP-01	229	VR-PR1000H	124
A12M18	RP-11	231			A13N14	RP-01	229	VR-PR1000H	124
A12M2	RP-11	231			A13N140T			VR-PR132B	125
A12M3	RP-11	231			A13N141T			VR-PR132B	125
A12M6	RP-11	231			A13N142T			VR-PR132B	125
A12M7	RP-11	231			A13N143M			VR-PR135B	125
A12M9			VR-PR123	124	A13N146T	RP-03	229		
A12R1	RP-10	231			A13N147M	RP-02	229		
A12R10	RP-10	231			A13N148M	RP-02	229		
A12R11	RP-10	231			A13N149M	RP-02	229		
A12R12	RP-10	231			A13N15	RP-01	229	VR-PR1000H	124
A12R13	RP-10	231			A13N150	RP-01	229		

**CROSS REFERENCE
Voltage Regulator**

**CROSS REFERENCE
Rectifier**

**CROSS REFERENCE
Diode Trio**

**ALTERNATOR NO.
Reg & Rec**

CROSS REFERENCE LIST

OEM Alternator No. → Mobiletron No.

OEM Alternator No.	Rectifier No.	Page	Regulator No.	Page	OEM Alternator No.	Rectifier No.	Page	Regulator No.	Page
A13N152M	RP-02	229	VR-PR135B	125	A13N7	RP-01	229		
A13N156	RP-01	229			A13N76	RP-19	232	VR-PR126	124
A13N157	RP-01	229			A13N80			VR-PR128	125
A13N158	RP-01	229			A13N81	RP-08	230	VR-PR1000H	124
A13N159	RP-03	229			A13N82	RP-03	229		
A13N160	RP-01	229			A13N83	RP-04	229		
A13N161	RP-01	229			A13N84	RP-03	229		
A13N162	RP-01	229			A13N85	RP-01	229	VR-PR1000H	124
A13N163	RP-01	229			A13N86	RP-01	229	VR-PR1000H	124
A13N164	RP-08	230			A13N87	RP-03	229	VR-PR1000H	124
A13N165			VR-PR128	125	A13N88	RP-07	230	VR-PR1000H	124
A13N167	RP-09R	231			A13N89	RP-01	229	VR-PR1000H	124
A13N17	RP-01	229	VR-PR1000H	124	A13N9	RP-04	229		
A13N171	RP-07	230			A13N90	RP-08	230	VR-PR1000H	124
A13N172	RP-03	229			A13N91	RP-03	229		
A13N173	RP-03	229			A13N92	RP-03	229	VR-PR126	124
A13N174			VR-PR128B	125	A13N93			VR-PR128	125
A13N178	RP-04H	229			A13N94	RP-04	229		
A13N179	RP-04H	229			A13N95	RP-09R	231		
A13N18	RP-03	229	VR-PR1000H	124	A13N97	RP-01	229	VR-PR1000H	124
A13N180	RP-03	229			A13R218			VR-PR1000H	124
A13N181	RP-09R	231			A13R221			VR-PR1000H	124
A13N182	RP-09	230			A13R222			VR-PR1000H	124
A13N183	RP-09	230			A13R228			VR-PR1000H	124
A13N184			VR-PR1926	126	A13R230			VR-PR1000H	124
A13N185	RP-08	230			A13R231			VR-PR1000H	124
A13N186	RP-02	229			A13R242			VR-PR1000H	124
A13N187	RP-01	229			A13R243			VR-PR1000H	124
A13N188	RP-01	229			A13R247			VR-PR1000H	124
A13N19	RP-03	229	VR-PR1000H	124	A13R248	RP-04R	230		
A13N190			VR-PR128B	125	A13R255			VR-PR1000H	124
A13N1M	RP-02	229			A13R256			VR-PR1000H	124
A13N20	RP-03	229	VR-PR1000H	124	A13R258	RP-03	229	VR-PR1000H	124
A13N218	RP-09	230			A13R259	RP-04R	230		
A13N21T			VR-PR128	125	A13R260			VR-PR1000H	124
A13N220	RP-09A	231			A13R266	RP-04R	230		
A13N22T	RP-06HR	230	VR-PR128B	125	A13R267	RP-04R	230	VR-PR2000H	127
A13N234			VR-PR7736	130	A13R268	RP-04R	230	VR-PR2000H	127
A13N25	RP-04	229			A13R270			VR-PR1000H	124
A13N256			VR-PR132B	125	A13R33	RP-06H	230		
A13N259			VR-PR7736	130	A13V172			VR-PR1669	126
A13N26			VR-PR128	125	A13V173			VR-PR1669	126
A13N27	RP-01	229	VR-PR1000H	124	A13V110	RP-48	233		
A13N285			VR-PR7736	130	A13V1101	RP-13	231		
A13N28M	RP-02	229	VR-PR135	125	A13V1102	RP-13	231		
A13N28T	RP-06HR	230			A13V111			VR-PR1667	126
A13N29	RP-01	229	VR-PR1000H	124	A13V1118	RP-23	232		
A13N2M	RP-02	229			A13V1126	RP-48	233		
A13N30	RP-01	229	VR-PR1000H	124	A13V1130	RP-48	233		
A13N31	RP-03	229	VR-PR1000H	124	A13V1134	RP-14	231		
A13N32	RP-04R	230	VR-PR2000H	127	A13V1135	RP-14	231		
A13N32T	RP-06HR	230			A13V1136			VR-PR002H	124
A13N33M	RP-02	229	VR-PR135BA	125	A13V1137	RP-14	231		
A13N34	RP-02	229	VR-PR128	125	A13V1138	RP-14	231		
A13N35M	RP-02	229			A13V114	RP-17	232	VR-PR1667	126
A13N36M	RP-02	229	VR-PR135BA	125	A13V1147			VR-PR6366	130
A13N37	RP-19	232			A13V1150	RP-48	233	VR-PR3617H	129
A13N38	RP-04R	230			A13V1151			VR-PR1060H	124
A13N39	RP-04	229	VR-PR2000H	127	A13V1153	RP-17	232		
A13N3T	RP-06HR	230			A13V1155	RP-14	231		
A13N40	RP-04R	230			A13V1156	RP-14	231		
A13N41	RP-04	229	VR-PR2000H	127	A13V1157			VR-PR002H	124
A13N42	RP-04	229			A13V116	RP-17	232	VR-PR1667	126
A13N43	RP-03	229	VR-PR126	124	A13V1160			VR-PR3617H	129
A13N44T	RP-06H	230			A13V1163			VR-PR002H	124
A13N45T	RP-06H	230			A13V1167	RP-35	232		
A13N46	RP-04	229			A13V117	RP-17	232	VR-PR1667	126
A13N47	RP-04	229			A13V1170	RP-14	231		
A13N49	RP-01	229	VR-PR1000H	124	A13V1175	RP-14	231		
A13N4T	RP-06HR	230	VR-PR128B	125	A13V1176	RP-14	231		
A13N50	RP-01	229	VR-PR1000H	124	A13V1178	RP-27	232	VR-PR003H	124
A13N51	RP-02	229	VR-PR132B	125	A13V1180	RP-14	231		
A13N52	RP-02	229	VR-PR128	125	A13V1188			VR-PR1620H	126
A13N53	RP-01	229	VR-PR1000H	124	A13V1194			VR-PR6366	130
A13N56M			VR-PR135B	125	A13V1195			VR-PR1620H	126
A13N57M	RP-02	229			A13V1198	RP-14	231		
A13N59M			VR-PR135BA	125	A13V120	RP-17	232	VR-PR1667	126
A13N5T	RP-06HR	230	VR-PR128B	125	A13V1202	RP-27	232	VR-PR003H	124
A13N6	RP-01	229	VR-PR1000H	124	A13V121	RP-17	232	VR-PR1667	126
A13N61T	RP-06HR	230			A13V122	RP-17	232		
A13N62	RP-07	230			A13V123	RP-17	232	VR-PR1667	126
A13N64	RP-01	229	VR-PR1000H	124	A13V1235			VR-PR1620H	126
A13N65	RP-01	229	VR-PR1000H	124	A13V1237	RP-27	232	VR-PR003H	124
A13N66M	RP-02	229			A13V1238			VR-PR1620H	126
A13N69	RP-19	232	VR-PR126	124	A13V124	RP-14	231		

CROSS REFERENCE
Voltage Regulator

CROSS REFERENCE
Rectifier

CROSS REFERENCE
Diode Trio

ALTERNATOR NO.
Reg & Rec

CROSS REFERENCE LIST

OEM Alternator No. → Mobiletron No.

OEM Alternator No.	Rectifier No.	Page	Regulator No.	Page	OEM Alternator No.	Rectifier No.	Page	Regulator No.	Page
A13VI249			VR-PR1620H	126	A14N150	RP-03	229		
A13VI25	RP-17	232	VR-PR1667	126	A14N151	RP-01	229		
A13VI251			VR-PR1620H	126	A14N16	RP-09R	231	VR-PR2000H	127
A13VI252			VR-PR1620H	126	A14N172			VR-PR1926	126
A13VI253			VR-PR1620H	126	A14N18	RP-04H	229		
A13VI257	RP-27	232	VR-PR003H	124	A14N19	RP-19	232		
A13VI259			VR-PR1620H	126	A14N2	RP-03	229	VR-PR130	125
A13VI28	RP-17	232	VR-PR1667	126	A14N200			VR-PR3729A	129
A13VI285			VR-PR1620H	126	A14N200M			VR-PR3729A	129
A13VI289			VR-PR1620H	126	A14N206M			VR-PR135B	125
A13VI290			VR-PR1620H	126	A14N22	RP-03	229	VR-PR126	124
A13VI291			VR-PR1620H	126	A14N23	RP-04	229	VR-PR2000H	127
A13VI297			VR-PR1620H	126	A14N30M			VR-PR135BA	125
A13VI30	RP-17	232			A14N33M			VR-PR3729A	129
A13VI300			VR-PR1620H	126	A14N35	RP-03	229	VR-PR126	124
A13VI31	RP-13	231	VR-PR1667	126	A14N36	RP-03	229	VR-PR126	124
A13VI32	RP-17	232	VR-PR1667	126	A14N37			VR-PR126	124
A13VI34	RP-17	232	VR-PR1667	126	A14N38	RP-05H	230	VR-PR2700	128
A13VI35	RP-17	232	VR-PR1667	126	A14N39			VR-PR128B	125
A13VI45	RP-17	232	VR-PR1667	126	A14N4	RP-08	230		
A13VI46	RP-15	231			A14N40	RP-01	229		
A13VI47	RP-17	232	VR-PR1667	126	A14N42	RP-03	229		
A13VI48	RP-13	231			A14N47M	RP-02	229	VR-PR135BA	125
A13VI49	RP-15	231			A14N48M			VR-PR135	125
A13VI52	RP-17	232			A14N50	RP-01	229	VR-PR1000H	124
A13VI54	RP-14	231			A14N51	RP-03	229	VR-PR1000H	124
A13VI55	RP-17	232			A14N53	RP-08	230	VR-PR1000H	124
A13VI57	RP-17	232			A14N54	RP-08	230	VR-PR1000H	124
A13VI62	RP-17	232			A14N55	RP-03	229	VR-PR126	124
A13VI64	RP-17	232			A14N56	RP-03	229	VR-PR1000H	124
A13VI65	RP-17	232			A14N59	RP-03	229	VR-PR126	124
A13VI66	RP-17	232			A14N60	RP-03	229	VR-PR1000H	124
A13VI67	RP-14	231			A14N62			VR-PR1000H	124
A13VI69	RP-14	231			A14N63	RP-03	229	VR-PR1000H	124
A13VI70	RP-14	231			A14N64	RP-03	229	VR-PR1000H	124
A13VI74	RP-14	231			A14N65	RP-03	229	VR-PR1000H	124
A13VI75	RP-14	231			A14N66M			VR-PR135	125
A13VI77	RP-14	231			A14N67	RP-21	232	VR-PR2700	128
A13VI78	RP-14	231			A14N69	RP-01	229	VR-PR1000H	124
A13VI79	RP-14	231			A14N70	RP-01	229	VR-PR1000H	124
A13VI85	RP-13	231			A14N71	RP-05H	230	VR-PR2700	128
A13VI86	RP-13	231			A14N73	RP-20	232	VR-PR126	124
A13VI87	RP-13	231			A14N75	RP-21	232	VR-PR126	124
A13VI97			VR-PR1671	126	A14N76	RP-20	232	VR-PR1000H	124
A14E25T			VR-PR1000H	124	A14N77	RP-03	229	VR-PR1000H	124
A14E45			VR-PR1000H	124	A14N78	RP-04	229	VR-PR2000H	127
A14N07	RP-04	229			A14N80	RP-04HR	229	VR-PR2000H	127
A14N1	RP-03	229	VR-PR130	125	A14N81M	RP-02	229	VR-PR135BA	125
A14N10	RP-03	229	VR-PR126	124	A14N82	RP-04HR	229		
A14N100M	RP-02	229	VR-PR3729A	129	A14N83	RP-03	229	VR-PR126	124
A14N101	RP-03	229			A14N84	RP-03	229	VR-PR126	124
A14N102	RP-03	229	VR-PR1000H	124	A14N85	RP-01	229	VR-PR1000H	124
A14N103	RP-03	229			A14N86	RP-01	229	VR-PR1000H	124
A14N104	RP-20	232	VR-PR128B	125	A14N88	RP-04HR	229	VR-PR2000H	127
A14N106	RP-01	229			A14N89	RP-03	229	VR-PR1000H	124
A14N107	RP-01	229			A14N9	RP-03	229	VR-PR126	124
A14N11	RP-05H	230			A14N90	RP-04	229		
A14N112M	RP-02	229	VR-PR135B	125	A14N91	RP-04H	229	VR-PR2000H	127
A14N113	RP-03	229	VR-PR1000H	124	A14N92	RP-04H	229		
A14N114T			VR-PR132B	125	A14N93	RP-04	229		
A14N115M			VR-PR135B	125	A14N95	RP-21	232	VR-PR1000H	124
A14N116M			VR-PR135B	125	A14N96			VR-PR1000H	124
A14N117	RP-03	229	VR-PR1000H	124	A14N97	RP-04	229	VR-PR1000H	124
A14N118M	RP-02	229			A14N99	RP-03	229	VR-PR1000H	124
A14N119M	RP-02	229	VR-PR3729A	129	A14R33			VR-PR128B	125
A14N12	RP-01	229	VR-PR1000H	124	A14R341T			VR-PR127B	125
A14N121	RP-03	229			A14R34T			VR-PR127B	125
A14N122M	RP-02	229	VR-PR135BA	125	A14R35			VR-PR130	125
A14N124	RP-21	232			A14R37			VR-PR130	125
A14N125	RP-01	229			A14R42			VR-PR130	125
A14N13	RP-01	229	VR-PR1000H	124	A14R46			VR-PR130	125
A14N130	RP-03	229			A14R541T			VR-PR127B	125
A14N131	RP-01	229			A14R542T			VR-PR127B	125
A14N132	RP-08	230			A14R543T			VR-PR127B	125
A14N133			VR-PR128B	125	A14R54T			VR-PR127B	125
A14N134	RP-03	229			A14VI10	RP-37	232		
A14N135			VR-PR128B	125	A14VI11	RP-37	232		
A14N137			VR-PR3729A	129	A14VI13	RP-37	232		
A14N137M	RP-02	229	VR-PR135BA	125	A14VI130	RP-37	232		
A14N138			VR-PR128B	125	A14VI131	RP-37	232		
A14N139			VR-PR1926	126	A14VI14	RP-37	232		
A14N14			VR-PR1000H	124	A14VI19			VR-PR3960	129
A14N140	RP-20	232			A14VI21			VR-PR1935	127
A14N141M			VR-PR135BA	125	A14VI39			VR-PR1935	127
A14N142	RP-03	229			A14VI63			VR-PR2339	128

CROSS REFERENCE
Voltage Regulator

CROSS REFERENCE
Rectifier

CROSS REFERENCE
Diode Trio

ALTERNATOR NO.
Reg & Rec

CROSS REFERENCE LIST

OEM Alternator No. → Mobiletron No.







OEM Alternator No.	Rectifier No.	Page	Regulator No.	Page	OEM Alternator No.	Rectifier No.	Page	Regulator No.	Page
CVS082576			VR-PR2292H	127					
CVS082593			VR-PR2292H	127					
CVS082613			VR-PR2292H	127					
HD90S013			VR-PR3430	128					
HD90S014			VR-PR3430	128					
HD90S015			VR-PR3430	128					
S13E50	RT-20H	233							
SA14V163			VR-PR2339	128					
SG10B010			VR-PR2299H	127					
SG10B011			VR-PR2299H	127					
SG10B016			VR-PR2299H	127					
SG10B018			VR-PR2765	128					
SG10B019			VR-PR2299H	127					
SG10B020			VR-PR2299H	127					
SG10B021	RP-51	233							
SG10B022	RP-51	233							
SG10B023	RP-51	233							
SG10B031			VR-PR2299H	127					
SG10B032			VR-PR2299H	127					
SG10B041			VR-PR3534	128					
SG10B048	RP-51	233							
SG10S028			VR-PR2765	128					
SG10S030			VR-PR2765	128					
SG12B010			VR-PR2292H	127					
SG12B011			VR-PR2292H	127					
SG12B015			VR-PR2292H	127					
SG12B017			VR-PR2299H	127					
SG12B018			VR-PR2292H	127					
SG12B020	RP-40H	233							
SG12B024			VR-PR2293	127					
SG12B025			VR-PR2292H	127					
SG12B030			VR-PR2299H	127					
SG12B042			VR-PR2292H	127					
SG12B047			VR-PR2292H	127					
SG12B054			VR-PR2292H	127					
SG12S057			VR-PR2765	128					
SG12S075			VR-PR2765	128					
SG12S083			VR-PR2765	128					
SG12S104			VR-PR2765	128					
SG12S120			VR-PR2765	128					
SG14B020			VR-PR2206	127					
SG15L020	RP-41	233							
SG15L023	RP-41	233							
SG15L027	RP-41	233							
SG15S019			VR-PR4920	129					
SG15S021			VR-PR3534	128					
SG15S022			VR-PR3534	128					
SG7S014			VR-PR3534	128					
SG7S024			VR-PR3534	128					
SG8B020			VR-PR3534	128					
SG9B010			VR-PR2292H	127					
SG9B011			VR-PR2292H	127					
SG9B013			VR-PR2292H	127					
SG9B015			VR-PR2292H	127					
SG9B018			VR-PR2292H	127					
SG9B019			VR-PR2292H	127					
SG9B023			VR-PR2292H	127					
SG9B042			VR-PR2292H	127					
TG11C024	RP-43	233							
TG11S115			VR-PR2292H	127					
TG12C013			VR-PR4920	129					
TG15C015			VR-PR3534	128					
TG9C013			VR-PR4920	129					
VISTEON									
1S7T-10300BA			VR-VN001	131					
1S7T-10300BB			VR-VN001	131					
1S7T-10300BC			VR-VN001	131					
20-150-01005			VR-VN001	131					
20-150-01011			VR-VN005	131					
2S6T-10300FA			VR-VN002	131					
3N21-10300BB			VR-VN002	131					
8440			VR-VN001	131					
XS611-0300BD			VR-VN002	131					
XS611-0300BE			VR-VN002	131					
XS611-0300BG			VR-VN002	131					

CROSS REFERENCE
Voltage Regulator

CROSS REFERENCE
Rectifier

CROSS REFERENCE
Diode Trio

ALTERNATOR NO.
Reg & Rec

 <p>BH-ND01</p> <p>Replaces DENSO : 021620-2180,021620-2630</p>	 <p>BH-ND03</p> <p>Replaces DENSO : 021620-2430</p>
 <p>BH-ND06</p> <p>Replaces DENSO : 104210-3512 FORD : 3M5T-10300PC</p>	 <p>BH-ND08</p> <p>Replaces DENSO : 104210-8310 HYUNDAI : 37300-3C170 TOYOTA : 27060-40060</p>
 <p>BH-ND10</p> <p>Replaces DENSO : 021620-2720 TOYOTA : 27370-42010</p> <p>Unit No. DENSO : 100211-6030,100211-6031,100211-6050...</p>	 <p>BH-ND11</p> <p>Replaces DENSO : 021620-3001</p> <p>Unit No. DENSO : 421000-0030,421000-0021,421000-0022...</p>
 <p>BH-ND12</p> <p>Unit No. DENSO : 104210-205,104210-208,104210-209... FORD : 7C3T-10300EE</p>	

- Brush Holder
- Voltage Regulator
- Repair Circuit
- Rectifier
- Diode Trio
- Diode
- Tester



BH-H02

Unit No.

HITACHI : LR1100-704B,LR1100-709,LR160-727...

Brush Holder

Voltage Regulator

Repair Circuit



Rectifier

Diode Trio

Diode

Tester

 <p>BH-H02</p> <p>Unit No. HITACHI : LR1100-704B,LR1100-709,LR160-727...</p>	

 <p>BH-M01 Unit No. CHRYSLER : 4661998,4671041,4686106,4793189,4793190 MITSUBISHI : A2T81192,A2T81292,A2T81391</p>	 <p>BH-M03 Unit No. FORD : FL1T-10300AA,FL1Z-10346A HONDA : 31100-5R0-004,31100-5R7-A01... MITSUBISHI : A5TZ0091,A003TV0691ZC</p>

- Brush Holder
- Voltage Regulator
- Repair Circuit
- Rectifier
- Diode Trio
- Diode
- Tester

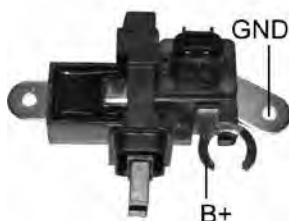
**TB-B001**

*Terminal Block

Replaces

BOSCH : 6-004-MR0-000,F-00M-145-250,F-00M-145-426...

Unit No.

BOSCH : 0-124-425-001,0-124-515-084...

CHRYSLER : 56028237,56028237AB,56028238,56028238AB...

**VR-B020**

*B-Circuit
 *LIN 1-1
 *19200 Baud Rate
 *Requires COM01 test adaptor for testing
 *ID Code: 48

Replaces

BOSCH : F-00M-346-020,F-00M-346-036,F-00M-346-048...

Unit No.

BOSCH : 0-120-000-025,0-121-813-001...

**VR-B021**

*B-Circuit
 *Voltage Set Point: 14.2V
 *LIN 1-1
 *19200 Baud Rate (4 Byte)
 *Requires COM01 test adaptor for testing
 *ID Code: 56

Replaces

BOSCH : F-00M-346-008,F-00M-346-021,F-00M-346-037...

Unit No.

BOSCH : 0-121-715-006,0-121-715-007...

MERCEDES : 0131543502,0131545602,0131547002...

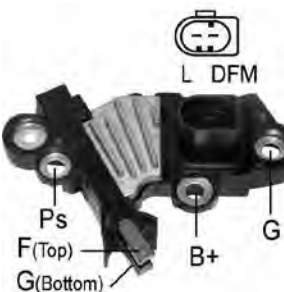
**VR-B026**

*B-Circuit
 *Soft Start
 *8.5 sec. LRC
 *Short Circuit Protection
 *Voltage Set Point: 14.5V
 *FR is in phase with F

Replaces

BOSCH : F-00M-346-010,F-00M-346-015,F-00M-346-026...

Unit No.

BOSCH : 0-121-615-001,0-121-615-002...

FORD : 6C1T-10300AA,6C1T-10300AB,6C1T-10300AC

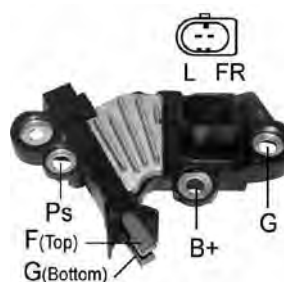
**VR-B029**

*B-Circuit
 *Soft Start
 *3.0 sec. LRC
 *Short Circuit Protection
 *Voltage Set Point: 14.4V

Replaces

BOSCH : F-00M-346-029,F-00M-346-053,F-00M-346-136

Unit No.

BOSCH : 0-121-615-013,0-121-615-029...

**VR-B033**

*B-Circuit
 *BSS 3 Connections
 *Requires COM01 test adaptor for testing
 *ID Code: 6

Replaces

BMW : 12317551254,12317551256,12317561924,12317561939

BOSCH : F-00M-346-013,F-00M-346-024,F-00M-346-033...

Unit No.

BMW : 12317542351,12317550469,12317551254...

BOSCH : 0-121-715-012,0-121-715-016...

**VR-B056**

- *B-Circuit
- *Voltage Set Point: 13.8V
- * LIN-1
- * 9600 Baud Rate (4 Byte)
- *Requires COM01 test adaptor for testing
- *ID Code: 88

Replaces

BOSCH : F-00M-346-005,F-00M-346-019,F-00M-346-056...
FORD : CN15-10316AA
VOLVO : 300667453,300667454

Unit No.

BOSCH : 0-120-000-003,0-120-000-029...

**VR-B057**

- * B-Circuit
- * Voltage Set Point: 13.8V
- * LIN-1
- * 9600 Baud Rate (4 Byte)
- * Requires COM01 test adaptor for testing
- *ID Code: 88

Replaces

BOSCH : F-00M-346-074,F-00M-346-165,F-00M-346-023...

Unit No.

BOSCH : 0-125-711-005,0-121-615-011...
FORD : BG9T-10300AB

**VR-B066**

- *B-Circuit
- *BSS Connections
- *Requires COM01 test adaptor for testing

Replaces

BOSCH : F-00M-346-066,F-00M-346-061

Unit No.

BOSCH : 0-121-615-027,0-121-615-012...

**VR-B0701**

- *B-Circuit
- *Soft Start
- *2.5sec LRC
- *Short Circuit Protection
- *Voltage Set Point :14.5V

Replaces

BOSCH : 0-272-220-701,0-272-220-720,0-272-220-731...

Unit No.

BOSCH : F-000-BL0-730,F-000-BL0-424...
VOLKSWAGEN : 04E903025J,06K903023,06K903023X

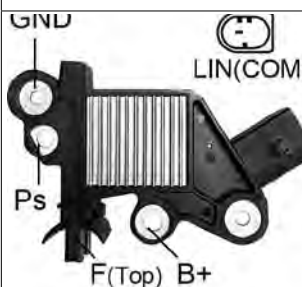
**VR-B0818**

- *B-Circuit
- *Voltage Set Point: 14.3V
- *LIN
- *9600/19200 Baud Rate (4 Byte)
- *ID Code: 120

Replaces

BOSCH : 0-272-220-818

Unit No.

BMW : 12318614277
BOSCH : 0-125-813-016,0-125-813-015

**VR-B088**

- *B-Circuit
- *BSS Connections
- *Requires COM01 test adaptor for testing

Replaces

BOSCH : F-00M-346-032,F-00M-346-025,F-00M-346-014...

Unit No.

BMW : 12317550967,12317551254
BOSCH : 0-121-615-010

**VR-B092**

*B-Circuit
 *Voltage Set Point: 14.2V
 * LIN 1-1
 * 19200 Baud Rate (4 Byte)
 * Requires COM01 test adaptor for testing
 *ID Code: 40

Replaces

BOSCH : F-00M-346-092,F-00M-346-139

Unit No.

BOSCH : 0-121-715-078,0-121-715-049...

**VR-B100**

*B-Circuit
 *24V
 *Inactive Lamp
 *Voltage Set Point:28.0V

Replaces

BOSCH : 9-190-085-000

Unit No.

BOSCH : 9-120-080-039,
9-120-080-049...

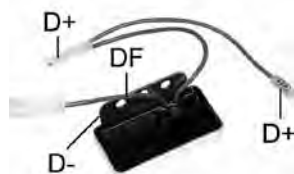
**VR-B102**

*B-Circuit
 *Inactive Lamp
 *Voltage Set Point:14.2V

Replaces

BOSCH : 9-190-457-007

Unit No.

BOSCH : 9-120-450-998

**VR-B103**

*A-Circuit
 *Voltage Set Point: 14.0V

Replaces

BOSCH : 9-190-087-026,
9-190-087-032

Unit No.

BOSCH : 0-120-484-011,
0-120-484-205...

**VR-B104**

*A-Circuit
 *Voltage Set Point: 14.2V

Replaces

BOSCH : 9-190-087-028

Unit No.

BOSCH : 9-120-080-161,
9-120-080-163...

**VR-B112**

*B-Circuit
 *Voltage Set Point: 14.3V
 *LIN
 *9600 & 19200 Baud Rate
 (4 Byte)
 *ID Code: 120

Replaces

BOSCH : F-00M-346-112

Unit No.

BOSCH : 0-125-813-002,0-125-813-009

**VR-B118B**

*24V
 *B-Circuit
 *Soft Start
 *S open Lamp on
 *Short Circuit Protection
 *Voltage Set Point: 28.3V

Replaces

BOSCH : F-00M-144-118,F-00M-145-299,F-00M-145-267...

Unit No.

BOSCH : 0-124-555-003,0-124-555-036...

**VR-B122B**

*24V
 *B-Circuit
 *Soft Start
 *Short Circuit Protection
 *Voltage Set Point: 25.6V

Replaces

BOSCH : F-00M-145-300,F-00M-144-122,F-00M-145-294...
HITACHI : 2500625

Unit No.

BOSCH : 0-124-555-013,0-124-555-014...

MAN : 51256010006

SCANIA : 1797688

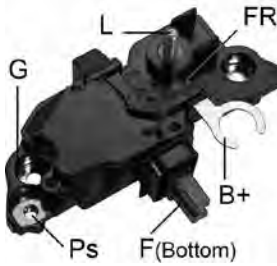
**VR-B129**

- *Soft Start
- *2.5 sec. LRC
- *Short Circuit Protection
- *Self Exciting
- *Voltage Set Point: 14.5V

Replaces

BOSCH : F-00M-144-129

Unit No.

BOSCH : 0-124-615-029,F-00M-145-313...

**VR-B131**

- *B-Circuit
- *BSS Connections
- *Requires COM01 test adaptor for testing

Replaces

BOSCH : F-00M-144-131,F-00M-145-304,F-00M-145-321...

Unit No.

BOSCH : 0-124-425-011,0-124-425-013...

RENAULT : 8000429905,8200323137,82 0323137...

**VR-B132**

- *A-Circuit
- *COM
- *BSS 3 Connections
- *Requires COM01 test adaptor for testing
- *ID Code: 12

Replaces

BOSCH : F-00M-144-108,F-00M-144-132,F-00M-145-292...

MERCEDES-BENZ : 0031544106,A0031545906,A0031547106...

Unit No.

BOSCH : 0-124-625-014,0-124-625-015...

MERCEDES-BENZ : 0121549902,0131540002

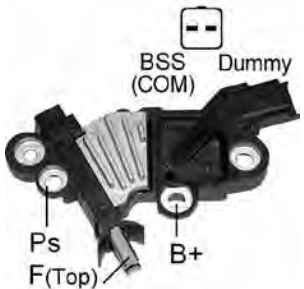
**VR-B135**

- *B-Circuit
- *BSS Connections
- *Requires COM01 test adaptor for testing

Replaces

BOSCH : F-00M-346-135

Unit No.

BMW : 12317604782,12317613445

BOSCH : 0-125-711-011

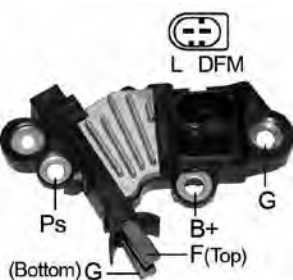
**VR-B137**

- * B-Circuit
- * Soft Start
- * 8.5 sec. LRC
- * Short Circuit Protection
- * Voltage Set Point: 14.5V
- * FR phase and F phase reverse

Replaces

BOSCH : F-00M-346-137

Unit No.

BOSCH : 0-121-715-003

**VR-B150**

- *B-Circuit
- *Voltage Set Point: 14.2V
- *LIN-2
- *19200 Baud Rate (4 Byte)
- *Requires COM01 test adaptor for testing
- *ID Code: 8

Replaces

BOSCH : F-00M-145-665,F-00M-145-698,F-00M-145-323...

MERCEDES-BENZ : 003-154-72-06,003-154-96-06,31547206...

Unit No.

BOSCH : 0-124-325-170

MERCEDES : A6461540002

**VR-B160**

- *B-Circuit
- *Soft Start
- *8.5 sec. LRC
- *Short Circuit Protection
- *Voltage Set Point: 14.5V

Replaces

BOSCH : F00M144109,F00M144160,F00M145345

Unit No.

BOSCH : 0-124-325-163,0-124-325-171...

Brush Holder

Voltage Regulator

Repair Circuit

Rectifier

Diode Trio

Diode

Tester

**VR-B190**

- *Mechanic Type
- *Voltage Set Point:14.8V

Replaces

ALFA ROMEO : 530165

AUDI/VW : 021903803A,043903803B,059903803A,21903803...

BMW : 01244409,1350052,1355456,8708000

BOSCH : 0-190-600-001,0-190-600-002,0-190-600-003...

FAUN : 1713068

FIAT : 4224467

FORD : 11436766,11444238,11444273

IHC : 3136411R92,3144046R1

ISKRA : 11-125-009,11-125-015,11-125-106,AER2901...

JOHN DEERE : AT31413

KLOCKNER-HUMBOL-DEUTZ : 1160363EF8976...

LAMBORGHINI : 29429600

LIEBHRR : 6930211

LUCAS : 21931004,21931013,37697,NCB205,NCB403

MAGIRUS-DEUTZ : 1160363,1160376

MAGNETI MARELLI : 63400006,64800001

MAN : 51256017037,81256010002,81256010003...

MASSEY FERGUSON : 1718347M1

MERCEDES-BENZ : 11545106,11546806,11546906,11548406...

OPEL : 1204226,1204229,1204230,1204231,1204235...

PORSCHE : 90160320301,90160320600,90160320601...

RENAULT : 5000255685,5000273021,5001001392,7701014809

SAAB : 7334634

SCANIA : 229511,263903

SEAT : HB90600000

SEV MARCHAL : 72160602,72160702,72160902,72210002...

STEYR : 609F090019,614090017

VALEO : 505043,78700,97163,NC328

VALEO(DUCELLIER) : 510003,519002,8375

VALEO(MOTOROLA) : 9RH7005

VALEO(PARIS RHONE) : AYC2112,YL414

VOLVO : 01214719,1234519,1308030,241534,241808...

Unit No.

BOSCH : 0-120-400-522,0-120-400-537...

FORD : E8GY-10346-A,E8GY-10346-B,E9BZ-10346-A

HYUNDAI : 37300-21013,37300-21320,37900-21030

MANDO : AR160A

**VR-B191**

*Electronic Type

*Voltage Set Point:14.5V

Replaces

ALFA ROMEO : 530165

AUDI/VW : 021903803A,043903803B,059903803A,21903803...

BMW : 01244409,1350052,1355456,8708000

BOSCH : 0190600001,0190600002,0190600003,0190600004...

FAUN : 1713068

FIAT : 4224467

FORD : 11436766,11444238,11444273

IHC : 3136411R92,3144046R1

ISKRA : 11-125-009,11-125-015,11-125-106,AER2901...

JOHN DEERE : AT31413

KLOCKNER-HUMBOL-DEUTZ : 1160363EF8976...

LAMBORGHINI : 29429600

LIEBHERR : 6930211

LUCAS : 21931004,21931013,37697,NCB205,NCB403

MAGIRUS-DEUTZ : 1160363,1160376

MAGNETI MARELLI : 63400006,64800001

MAN : 51256017037,81256010002,81256010003...

MASSEY FERGUSON : 1718347M1

MERCEDES-BENZ : 11545106,11546806,11546906,11548406...

OPEL : 1204226,1204229,1204230,1204231,1204235...

PORSCHE : 90160320301,90160320600,90160320601...

RENAULT : 5000255685,5000273021,5001001392,7701014809

SAAB : 7334634

SCANIA : 229511,263903

SEAT : HB90600000

SEV MARCHAL : 72160602,72160702,72160902,72210002...

STEYR : 609F090019,614090017

VALEO : 505043,78700,97163,NC328

VALEO(DUCELLIER) : 510003,519002,8375

VALEO(MOTOROLA) : 9RH7005

VALEO(PARIS RHONE) : AYC2112,YL414

VOLVO : 01214719,1234519,1308030,241534,241808...

Unit No.

BOSCH : 0-120-400-522,0-120-400-537...

FORD : E8GY-10346A,E8GY-10346B,E9BZ-10346A

HYUNDAI : 37300-21013,37300-21320,37900-21030

MANDO : AR160A

**VR-B192**

*For 32mm OD slip ring

*Voltage Set Point:14.7V

Replaces

AUDI/VW : 028903803A,049903803B,049903803E...

BOSCH : 0-192-052-001,0-192-052-002,0-192-052-003...

FIAT : 4475269,9927829,9934791

FORD : 1477502,71BB-10316AA

MAGIRUS-DEUTZ : 42484638

MAGNETI MARELLI : 64808010,64808011,64808100,RTT110A...

MERCEDES-BENZ : 21540606,21541806,21542506,21545806

OPEL : 1204244

VALEO : 505055

VALEO(MOTOROLA) : 9RC7062

VOLVO : 244332

Unit No.

BOSCH : 0-120-339-526,0-120-339-527...

**VR-B193M**

*A-Circuit

*VR-B193M:V Setting 14.7V

*VR-B193ML:V Setting 14.2V

*VR-B193MA:V Setting 15.0V

*VR-B193MH:Heavy duty;V
Setting 14.7V

*For 32mm OD slip ring

Replaces**ALFA ROMEO** : 7001656**BMW** : 12311268073,12311268387,12311286073,12311710732**BOMAG** : 5710950,5710957**BOSCH** : 1197311000,1197311001,1197311002,1197311090...**DELCO** : 9009353**DELCO REMY (LUCAS)** : 21221347**FENDT** : K830060011010**FIAT** : 42490291,4474755,4731653,82302913,9933186...**FORD** : 50111364,6036646,6057627,74GB-10316AA...**GM** : 90009353**IHC** : 3079037R91,3079123R91**ISKRA** : 10-120-110,11-125-003,11-125-040,11-125-049...**JOHN DEERE** : AL36101,AZ24490**KLOCKNER-HUMBOL-DEUTZ** : 1173068,1177496,1306557...**LAMBORGHINI** : 294295100,294390903,296195100**LUCAS** : 1221152,21221347,21221373,21221411,21931009...**MAGNETI MARELLI** : 64808012,64808109**MAN** : 81256016020**MASSEY FERGUSON** : 3188023M1**MERCEDES-BENZ** : 21543206**OPEL** : 1204246,1204252**SAAB** : 8558306,8559577,8581779**SEAT** : 3894469,3899291,NG98102329**STEYR** : 30800090740,61000090742**VALEO** : NB411,505-055**Unit No.****BOSCH** : 0-120-339-515,0-120-339-516...**ISKRA** : 11201068,11201071,11201077,11201078...**VR-B194**

*A-Circuit

*VR-B194:V Setting 14.7V

*VR-B194L:V Setting 14.2V

*For 28mm OD slip ring

Replaces**BOSCH** : 0-192-052-015,0-192-052-016,0-192-052-020...**IHC** : 3079412R92**ISKRA** : 11-125-094,AER1519**JOHN DEERE** : AL30420,AL35999,AL65077**KLOCKNER-HUMBOL-DEUTZ** : 1308784**MERCEDES-BENZ** : 21544006**SAAB** : 8559585**SCANIA** : 280942**VOLVO** : 1323467,244489,244612**Unit No.****BOSCH** : 0-120-468-028,0-120-469-522...

**VR-B195M**

- *V setting 14.7V
- *VR-B195ML:V setting 14.2V
- *VR-B195MA:V setting 15.0V
- *VR-B195MH:Heavy duty;V setting 14.7V
- *For 28mm OD slip ring

Replaces

- AUDI/VW : 068903803B,068903803D,68903803,J2700004010
- BMW : 12311726002
- BOSCH : 1-197-311-004,1-197-311-005,1-197-311-006...
- DELCO REMY (LUCAS) : 21221432
- FIAT : 60743997,60751439,9938171,9942848,9942885...
- FORD : 1640169,6113735,82BB-10316AA,E5RD-10316BA
- GM : 90349704,90349907
- KLOCKNER-HUMBOLD-DEUTZ : 1318548,8121111
- LUCAS : 21221349,UCB403
- OPEL : 1204253,1204256,1204259,90007041,90349704
- PORSCHE : 92860315300,94460314100,94460314101
- SEAT : 3899919

Unit No.

- BOSCH : 0-120-468-001,0-120-468-002...

**VR-B196M**

- *With Resistor
- *For 28mm OD slip ring
- *VR-B196M:V Setting 14.7V
- *VR-B196ML:V Setting 14.2V

Replaces

- BMW : 12311279548,12321271644,12321711399,1711391
- BOSCH : 1197311003,1197311007,1197311009,1197311018...
- DELCO REMY (LUCAS) : 21221416
- FERRARI : 0121840
- FIAT : 60743883
- FORD : 86GB10316AA
- LUCAS : 21221412,UCB413,21221416
- MERCEDES-BENZ : 21544106,21545106,21547206
- PEUGEOT : 5761.47,5761.59
- SAAB : 8559619,8571846
- SEAT : 3980592

Unit No.

- BOSCH : 0-120-468-009,0-120-468-010...

**VR-B196MH**

- *For 28mm OD slip ring
- *With 68 ohm Resistor
- *Heavy duty type
- *Voltage Set Point:14.7V

Replaces

- AUDI/VW : 34903803
- BOSCH : 1-197-311-008,1-197-311-022,1-197-311-026...
- CITROEN : 9405761558
- FORD : 6165056,86GB-10316AA
- MERCEDES-BENZ : 21547902,21547906
- PEUGEOT : 5761.55
- PORSCHE : 96460314100
- SAAB : 8590549
- VOLVO : 1324617,3523710-6

**VR-B197**

*24V
 *For 32mm OD slip ring
 *Voltage Set Point:28.3V

Replaces

BOSCH : 0-192-053-001,0-192-053-002,0-192-053-004...
FIAT : 4701484,79022473,9988935
IHC : 3079147R91
ISKRA : 11-125-004,11-125-055,AER1403,AER1504,AER1507
IVECO : 9988935
KLOCKNER-HUMBOL-DEUTZ : 1306480,4701484,8122154
LUCAS : 21221125,21221348,UCB402
MAGIRUS-DEUTZ : 4701484
MAGNETI MARELLI : 64800007
MAN : 81256016013,81256016017
STEYR : 61500090706
VALEO : 505059,NB412
VALEO(MOTOROLA) : 9RC8090
VOLVO : 244344,244426

Unit No.

BOSCH : 0-120-339-537,0-120-339-538...

**VR-B198**

*24V
 *For 28mm OD slip ring
 *Voltage Set Point:28.3V

Replaces

BOSCH : 0-192-053-005,0-192-053-006,0-192-053-011...
DELCO REMY (LUCAS) : 21221350
FORD : 6094906
IHC : 3079392R91
ISKRA : 11-125-095,AER1520
IVECO : 79078923
KLOCKNER-HUMBOL-DEUTZ : 1171370,8122152
LIEBHRR : 5004185,5603582
LUCAS : 21931011,UCB404
MAN : 81256016014,81256016016,81256016023...
MERCEDES-BENZ : 21543806,21543906,21544706,21544906...
SONACOME : 1117344
STEYR : 61200090707,61500090729

Unit No.

BOSCH : 0-120-468-037,0-120-469-518...

**VR-B199-3**

*24V
 *Voltage Set Point:28.3V

Replaces

BOSCH : 0-192-033-001,0-192-033-002,0-192-033-004
FORD : 11635831
IHC : 3055449R91,3132862R1
KLOCKNER-HUMBOL-DEUTZ : 114440747,1161178,2404414...
LANCIA : 82243312,82294110
LIEBHRR : 6000094,6912707
LUCAS : 21931016,NCB407
MAGNETI MARELLI : 64800004
MAN : 30535010001,51256017029,51256017036...
MASSEY FERGUSON : 2945680M1
MERCEDES-BENZ : 11547006,11548106,11549106,21540506
RENAULT : 7701008802
SCANIA : 225662
STEYR : 610090021
VERSORGUNGS : 2920-12-158-8890
VOLVO : 102746
VOLVO/DAF : 241630,249264,870864

**VR-B199-3A**

*Voltage Set Point:14.5V

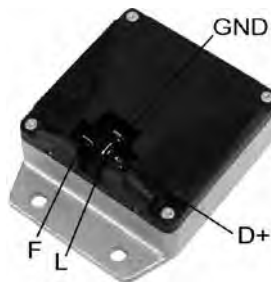
Replaces**BOSCH** : 9-190-087-005**VR-B199-4**

*24V

*Voltage Set Point:28.3V

Replaces**BOSCH** : 0-192-033-003,0-192-033-005**FAUN** : 1713071**IHC** : 3144931R1**KLOCKNER-HUMBOL-DEUTZ** : 1162829,2404417,8122110...**LANCIA** : 82301179**LIEBHERR** : 6201558,6912701**LUCAS** : 21931015,NCB406**MAGIRUS-DEUTZ** : 1162829**MAGNETI MARELLI** : 64800005**MAN** : 81256010010,81256010011,90801101322**MASSEY FERGUSON** : 2868511M91**MERCEDES-BENZ** : 11548806,21540206,3505477102**RENAULT** : 26563108,7701012214,7701015670**VOLVO/DAF** : 4785003**VR-B200H**

*A-Circuit

*w/o resistor

*Heavy Duty

*Voltage Set Point:14.6V

Replaces**AUDI/VW** : 021903803B,028903803B,028903803C,78903803**BOSCH** : 1197311212,1197311223,1197311224,1197311225...**DELCO** : 90487255**MERCEDES-BENZ** : 21548502**NISSAN** : 23215-72J00**VALEO** : 572587**Unit No.****BOSCH** : 0-120-465-007,0-120-465-008...**VR-B201H**

*w/180 ohm resistor

*Heavy Duty

*Voltage Set Point:14.6V

Replaces**BOSCH** : 1197311211,1197311213,1197311217,1197311219...**MERCEDES-BENZ** : 0021548106,0021548206,0021548506...**PEUGEOT** : 5761.85,5761.86,95644494**VALEO** : 3544570**Unit No.****BOSCH** : 0-120-465-004,0-120-465-006...**VR-B202**

*For 28mm OD slip ring

*Voltage Set Point:14.7V

Replaces**BOMAG** : 5710956**BOSCH** : 0-192-052-035,1-197-311-029,1-197-311-030...**KLOCKNER-HUMBOL-DEUTZ** : 1173069,1177145,1178644**MERCEDES-BENZ** : 1541805,21543706**Unit No.****BOSCH** : 0-120-469-526,0-120-469-540...

**VR-B202L**

*For 28mm OD slip ring
 *Voltage Set Point:14.2V
 *Same as VR-B202 but with lower volts setting

Replaces

BOSCH : 0192052033,0192052035,0192053032,1197311029...
KLOCKNER-HUMBOL-DEUTZ : 1173069,1177145,1178644
MERCEDES-BENZ : 1541805,21543706

Unit No.

BOSCH : 0-120-469-526,0-120-469-540...

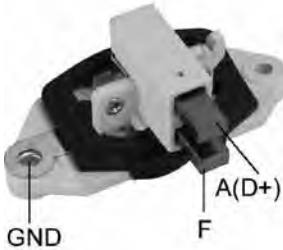
**VR-B203**

*A-Circuit
 *24V
 *For 28mm OD slip ring
 *Volts setting 28.3V

Replaces

BOSCH : 1197311300,1197311301,1197311304,0192053011...
KLOCKNER-HUMBOL-DEUTZ : 1178336
MERCEDES-BENZ : 1541705,21548406
SCANIA : 117253,305160,362645
VOLVO : 1606935,1625880,1698185,3239266,9600908

Unit No.

BOSCH : 0-120-468-053,0-120-468-065...

**VR-B204**

*For 28mm OD slip ring
 *Voltage Set Point:14.7V

Replaces

BOSCH : 0-192-052-023

Unit No.

BOSCH : 0-120-489-059,
 0-120-489-999...

**VR-B205**

*A-Circuit
 *For 28mm OD slip ring
 *Voltage Set Point:14.7V

Replaces

BOSCH : 0-192-052-030
TALBOT : 43269200

Unit No.

BOSCH : 9-120-144-231

**VR-B206**

*24V
 *For 28mm OD slip ring
 *Voltage Set Point:28.3V

Replaces

BOSCH : 0-192-053-003,0-192-053-009,0-192-053-012...
IVECO : 93157259
KLOCKNER-HUMBOL-DEUTZ : 1320082,1320381,8122275
MAN : 81256016015,81256016021,81256016025,81256016030
MERCEDES-BENZ : 21543506,21545506,21546806
VOLVO : 1698764

Unit No.

BOSCH : 0-120-689-503,0-120-689-512...

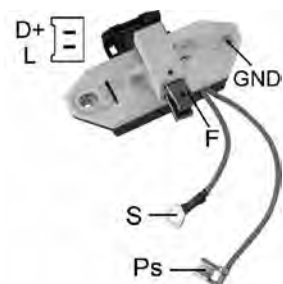
**VR-B207**

*For 28mm OD slip ring
 *Voltage Set Point:14.7V

Replaces

BOSCH : 0-192-052-023

Unit No.

BOSCH : 9-120-144-257,
 9-120-144-258...

Replaces

BOSCH : 0-120-689-503,0-120-689-512...

VR-B208H

*Same as VR-B201H except with 68 Ohm Resistor
 *Voltage Set Point:14.6V

Replaces

BOSCH : 1-197-311-234,1-197-311-239,1-197-311-514

Unit No.

BOSCH : 0-120-465-006,0-123-510-017...

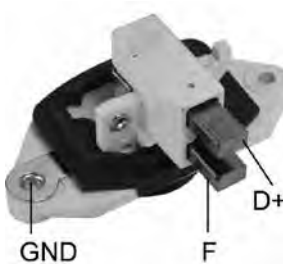
**VR-B209**







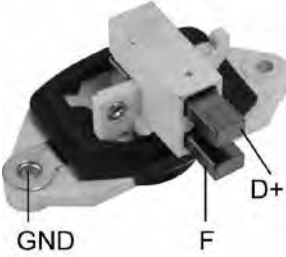

*24V
 *Same as VR-B203 but with higher volts setting(28.5V)

Replaces

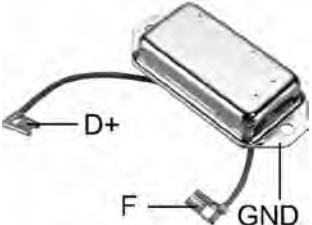
BOSCH : 1197311304,1197311324,6033RD2006
MERCEDES-BENZ : 21548406
SCANIA : 117253,362645
VOLVO : 1606935,1625880

Unit No.

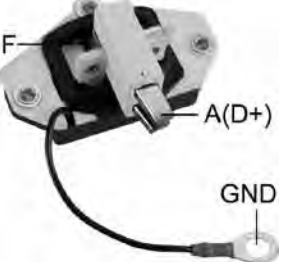
BOSCH : 0-120-468-065,0-120-468-066...

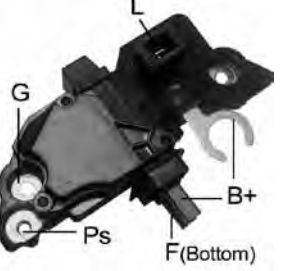
 <p>VR-B210 *A-Circuit *24V *Same as VR-B203 but with higher volts setting(29.0V)</p> <p>Replaces BOSCH : 1-197-311-309</p> <p>Unit No. BOSCH : 0-120-468-053, 0-120-468-065...</p>	 <p>VR-B211 *Voltage Set Point:14.2V</p> <p>Replaces BOSCH : 9-121-080-303, 9-190-087-003 VW/BRAZIL : 409038031</p> <p>Unit No. BOSCH : 9-120-080-061, 9-120-080-072...</p>	Brush Holder
 <p>VR-B212 *Voltage Set Point:14.7V</p> <p>Replaces BOSCH : 9-190-457-006 VW/BRAZIL : 409038031</p> <p>Unit No. BOSCH : 9-120-450-044, 9-120-450-071...</p>	 <p>VR-B215 *Electronic Type *Voltage Set Point:14.5V</p> <p>Replaces BOSCH : 9-190-455-001, 9-190-455-009</p>	Voltage Regulator
 <p>VR-B217H *A-Circuit *Heavy Duty *Voltage Set Point:14.2V</p> <p>Replaces BOSCH : 9-190-087-040</p>	 <p>VR-B218 *Voltage Set Point:14.2V</p> <p>Replaces BOSCH : 9-190-457-002</p> <p>Unit No. BOSCH : 9-120-450-006, 9-120-450-134...</p>	Repair Circuit
 <p>VR-B219 *24V *For 28mm OD slip ring *Bus Type Regulator *Scania Autobus with Mercedes Engine *Voltage Set Point:28.3V</p>	<p>Replaces BOSCH : 9190457003,192053021,1197311319,1197311320...</p> <p>Unit No. BOSCH : 9-120-456-003,9-120-456-014...</p>	Rectifier
 <p>VR-B220 *A-Circuit *Voltage Set Point:14.7V</p>	<p>Replaces BOSCH : 0192052007,1197311047,9191337311,0192052010 LUCAS : UCB407 MAGNETI MARELLI : 940038005</p> <p>Unit No. BOSCH : 0-120-489-506,0-120-489-565...</p>	Diode Trio
 <p>VR-B221 *A-Circuit * L Terminal Drives Choke *Soft Start *8.5 sec. LRC *Voltage Set Point:14.4V</p>	<p>Replaces BOSCH : F-00M-145-229,F-00M-A45-207,F-00M-145-352...</p> <p>Unit No. BOSCH : 0-124-515-017,0-124-515-054... VOLVO : 9442841</p>	Diode Tester

**VR-B222**

- *For 14mm OD slip ring
- *Voltage Set Point:14.6V

Replaces

AUDI/VW : 028903803D
 BOSCH : 1197311500,1197311523,1197311530,1197311531...

Unit No.

BOSCH : 0-123-325-005,
 0-123-325-006...

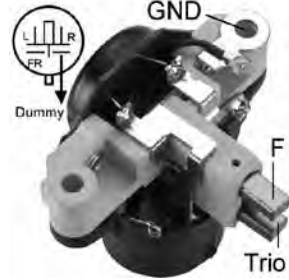
**VR-B225**

- *A-Circuit
- *For 14mm OD slip ring
- *Voltage Set Point:14.7V

Replaces

BOSCH : 1-119-311-231,
 1-197-311-231

Unit No.

BOSCH : 0-123-315-020,
 0-123-315-007

**VR-B226**

- *24V
- *For 28mm OD slip ring
- *Voltage Set Point:28.3V

Replaces

BOSCH : 9-191-337-310

Unit No.

BOSCH : 0-120-469-103,6033GB3047

**VR-B229**

- *For 14mm OD slip ring
- *Voltage Set Point:14.2V

Replaces

BOSCH : 1-197-311-518,
 1-197-311-520

Unit No.

BOSCH : 0-123-315-016,
 0-123-315-021 ...

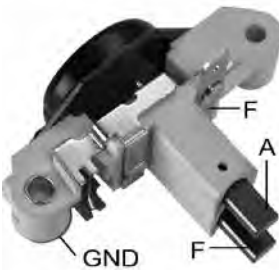
**VR-B235**

- *For 14mm OD slip ring
- *Voltage Set Point:14.6V

Replaces

BOSCH : 1-197-311-511

Unit No.

BOSCH : 0-123-505-017,
 0-123-510-007...

**VR-B238**

- *A-Circuit
- *For 14mm OD slip ring
- *Voltage Set Point:14.5V

Replaces

BOSCH : 1197311545,1197311506,1197311516,1197311536...

Unit No.

BOSCH : 0-123-315-013,
 0-123-325-010...

**VR-B240H**

- *For 14mm OD slip ring
- *Low Cut In Speed
- *VR-B240HL
 (Volts Setting 14.4V)
- *Voltage Set Point:14.6V

Replaces

BOSCH : 1-197-311-240,1-197-311-512,1-197-311-551...
 VOLVO : 1698764

Unit No.

BOSCH : 0-120-110-007,0-120-335-007...

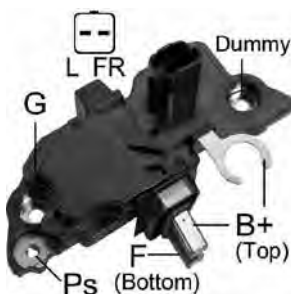
**VR-B242**

- *A-Circuit
- *Active Lamp
- *Soft Start
- *8 sec. LRC
- *Short Circuit Protection
- *Voltage Set Point:14.5V

Replaces

BOSCH : F-00M-141-381,F-00M-145-276,F-00M-145-368...

Unit No.

BOSCH : 0-124-525-028,0-124-525-043...

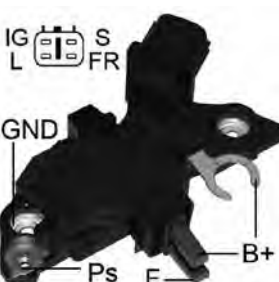
**VR-B243**

- *A-Circuit
- *Active Lamp
- *Soft Start
- *5.0 sec. LRC
- *Short Circuit Protection
- *Voltage Set Point:14.4V

Replaces

BOSCH : F00M145236,F00M145305,F00M145324,F00M145376...
 TOYOTA : 27700-0L020

Unit No.

BOSCH : 0-120-000-023,0-124-315-015...
 TOYOTA : 27060-0P010,27060-0J061

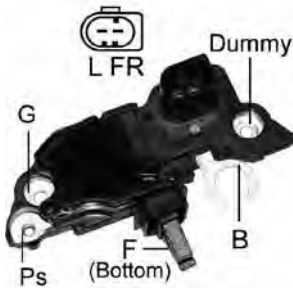
**VR-B244**

- *A-Circuit
- *Soft Start
- *2.5 sec. LRC
- *Soft Start delay 10 sec.
- *Short Circuit Protection
- *Voltage Set Point: 14.2V

Replaces

BOSCH : F-00M-145-244

Unit No.

BOSCH : 0-124-225-020

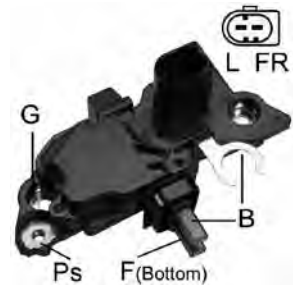
**VR-B247**

- *A-Circuit
- *Soft Start
- *2.5 sec. LRC
- *Short Circuit Protection
- *Voltage Set Point: 14.5V

Replaces

BOSCH : F-00M-145-247,F-00M-145-357,F-00M-144-138...

Unit No.

BOSCH : 0-124-325-040,0-124-515-055...

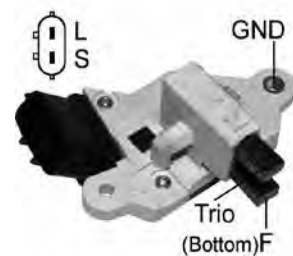
**VR-B250**

- *A-Circuit
- *Voltage Set Point: 14.6V

Replaces

BOSCH : 9-190-041-002

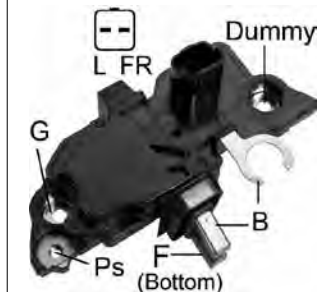
**VR-B251**

- *A-Circuit
- *For 14mm OD slip ring
- *Voltage Set Point: 14.5V

Replaces

BOSCH : F-00M-145-239, F-00M-A45-234,F-00M-144-111...

Unit No.

BOSCH : 0-124-325-024, 0-124-415-007...

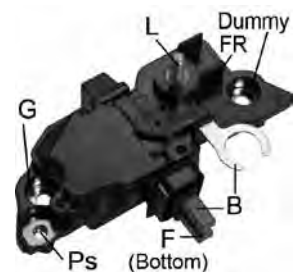
**VR-B252**

- *A-Circuit
- *For 14mm OD slip ring
- *Soft Start
- *8.5 sec. LRC
- *Short Circuit Protection
- *Voltage Set Point: 14.5V

Replaces

BOSCH : F-00M-145-201,F-00M-145-231,F-00M-144-142...

FIAT : 9949575

MERCEDES-BENZ : 0031541506

OPEL : 1204289,9117942,9201135,93176380

Unit No.

BOSCH : 0-124-215-001,0-124-215-003...

**VR-B253**

- *A-Circuit
- *Soft Start
- *Short Circuit Protection
- *Voltage Set Point: 14.5V

Replaces

BOSCH : F00M145214,F00M144183,F00M145348

Unit No.

BOSCH : 0-124-325-063,0-124-325-064...

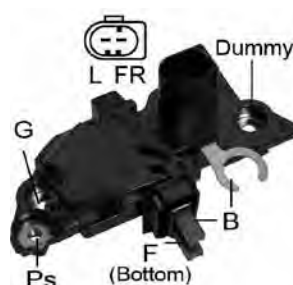
**VR-B254**

- *A-Circuit
- *For 14mm OD slip ring
- *2.5 Second LRC
- *Soft Start 30%
- *Short Circuit Protection
- *Voltage Set Point: 14.5V

Replaces

BOSCH : F-00M-145-225,F-00M-144-136,F-00M-145-350...

Unit No.

BOSCH : 0-124-215-006,0-124-225-012...

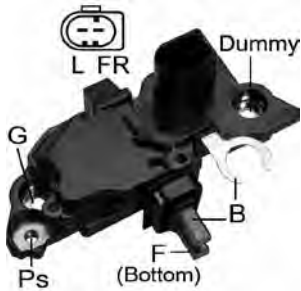
**VR-B255**

- *A-Circuit
- *For 14mm OD slip ring
- *Soft Start
- *8.5 Second LRC
- *Short Circuit Protection
- *Voltage Set Point:14.5V

Replaces

BOSCH : F-00M-145-206,F-00M-145-240,F-00M-145-269...

Unit No.

BOSCH : 0-124-325-006,0-124-325-007...

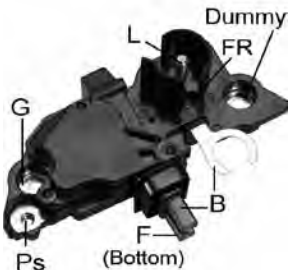
**VR-B256**

- *A-Circuit
- *For 14mm OD slip ring
- *Soft Start
- *2.5 sec. LRC
- *Short Circuit Protection
- *Voltage Set Point:14.5V

Replaces

BOSCH : F-00M-145-220,F-00M-145-349

Unit No.

BOSCH : 0-124-215-001,0-124-215-002...

**VR-B257**

- *A-Circuit
- *Soft Start
- *2.5 Second LRC
- *Short Circuit Protected
- *Voltage Set Point:14.3V

Replaces

BOSCH : 01229AA0X0,F00M225401,F00M225201

Unit No.

BOSCH : 0-122-0AA-0B0,0-122-0AA-2A0...

**VR-B259**

- *A-Circuit
- *Soft Start
- *2.5 sec. LRC
- *Short Circuit Protection
- *Voltage Set Point:14.6V

Replaces

BOSCH : F-00M-145-224,F-00M-145-241,F-00M-145-073

Unit No.

BOSCH : 6004MA5008,6004ML0017,6004ML0024

GM : 10418888

**VR-B260**

- *A-Circuit
- *For 32mm OD slip ring
- *Voltage Set Point:14.2V

Replaces

BOSCH : 1197311032,1197311033,1197311045,1197311046...

Unit No.

BOSCH : 0-120-484-011,0-120-488-134...

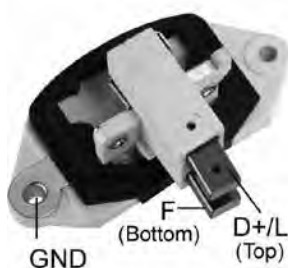
**VR-B260B**

- *24V
- *A-Circuit
- *Voltage Set Point:28.5V

Replaces

BOSCH : 1-197-311-310,1-197-311-313,1-197-311-314...

Unit No.

BOSCH : 0-120-488-206,0-120-488-234...

**VR-B261**

- *A-Circuit
- *Voltage Set Point: 14.4V

Replaces

BOSCH : 1-197-311-541

Unit No.

BOSCH : 0-123-320-040,0123320046,0123320047...

**VR-B262**

- *A-Circuit
- *Active Lamp
- *Soft Start
- *8.5 sec. LRC
- *Short Circuit Protection
- *Voltage Set Pont:14.5V

Replaces

BOSCH : F-00M-145-255,F-00M-A45-210,F-00M-145-361

Unit No.

BOSCH : 0-124-315-019,0-124-315-027...

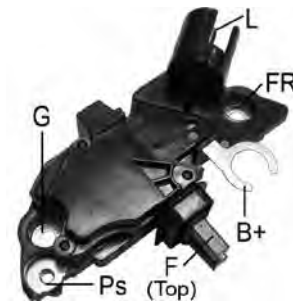
**VR-B263**

- *B-Circuit
- *Soft Start
- *2.5 Second LRC
- *Short Circuit Protected
- *Voltage Set Point:14.4V

Replaces

BOSCH : F-00M-145-252

Unit No.

BOSCH : 0-124-615-002,0-124-615-027

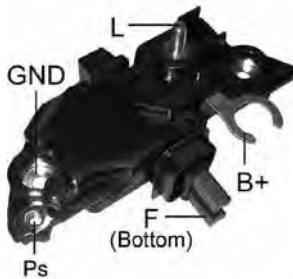
**VR-B264**

- *A-Circuit
- *Active Lamp
- *Soft Start
- *2.5 sec. LRC
- *Short Circuit Proection
- *Voltage Set Point:14.4V

Replaces

BOSCH : 0-031-542-906,F-00M-145-248,F-00M-145-358
MERCEDES-BENZ : 0031542806,0031545506,0031545606

Unit No.

BOSCH : 0-124-325-039,0-124-325-046...
CHRYSLER : 5134199AA,5134204AA,5134205AA
MERCEDES-BENZ : 0121541502,0121542002,0121542402...

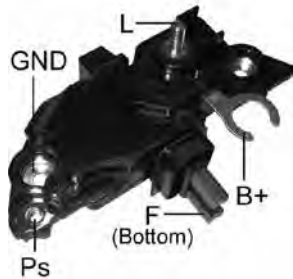
**VR-B265**

- *A-Circuit
- *Soft Start
- *2.5 sec LRC
- *Short Circuit Protection
- *Voltage Set Point:14.7V

Replaces

BOSCH : F-00M-145-227

Unit No.

BOSCH : 0-124-515-008,0-124-515-043
GM : 21019217,22674550,9227893

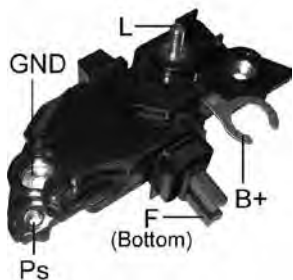
**VR-B266**

- *A-Circuit
- *Soft Start
- *0.5 Second LRC
- *Short Circuit Protected
- *Voltage Set Point:14.4V

Replaces

BOSCH : F-00M-145-271,F-00M-145-366

Unit No.

BOSCH : 0-124-525-016

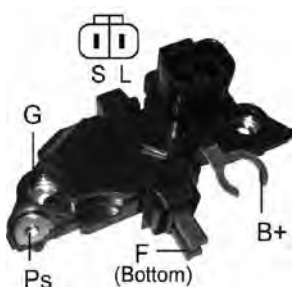
**VR-B267**

- *A-Circuit
- *Soft Start
- *5 Second LRC
- *Short Circuit Protected
- *Voltage Set Point:14.5V

Replaces

BOSCH : F-00M-145-207,F-00M-145-347,F-00M-A45-228

Unit No.

BOSCH : 0-124-325-008,0-124-325-010...

**VR-B268**

- *B-Circuit
- *Soft Start
- *0.5 Second LRC
- *Short Circuit Protected
- *Loss of Sense Lamp On
- *Voltage Set Point:28.3V

Replaces

BOSCH : F-00M-144-103,F-00M-144-119,F-00M-145-246...

Unit No.

BOSCH : 0-124-555-005,0-124-555-009...
CASE : 87715948
DAF : 1450808,1624197,1794477,1806492
IVECO : 42537055,42540208,42560643
KHD : 01182475
MERCEDES-BENZ : 0001542405
RENAULT : 7420523391
VOLVO : 2052339

**VR-B269**

- *A-Circuit
- *Voltage Set Point:14.5V

Replaces

BOSCH : F002G10376079

**VR-B270**

- *B-Circuit
- *Soft Start
- *2.5 Second LRC
- *Short Circuit Protected
- *Voltage Set Point:14.4V

Replaces

BOSCH : F00M145286,F00M145394,F00MA45233

Unit No.

BOSCH : 0-124-525-035

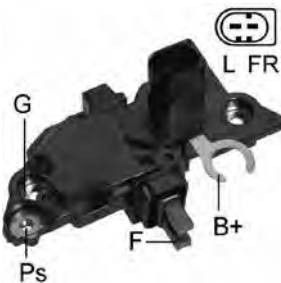
**VR-B271**

- *A-Circuit
- *0.5 Second LRC
- *Soft Start 18%
- *Voltage Set Point:14.4V

Replaces

AUDI/VW : 038903803F

BOSCH : F-00M-145-237,F-00M-145-238,F-00M-145-354...

Unit No.

BOSCH : 0-124-325-019,0-124-515-028

PICTURE IS NOT AVAILABLE

VR-B278

- *Requires COM01 test adaptor for testing
- *ID Code: 20

Replaces

BOSCH : F-00M-145-278,F-00M-A45-218,F-00M-145-678

Unit No.

BMW : 12-31-7-519-721,12-31-7-519-723...
BOSCH : 0-124-525-026

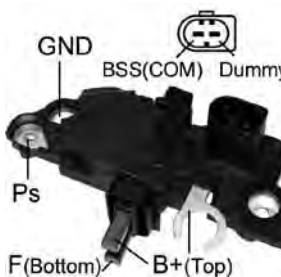
**VR-B280**

- *A-Circuit
- *BSS 3 Connections
- *Requires COM01 test adaptor for testing
- *ID Code: 08

Replaces

BMW : 12317515319

BOSCH : F-00M-145-280,F-00M-145-679,F-00M-A45-219

Unit No.

BOSCH : 0-124-515-105,0-124-425-001...

**VR-B285**

*A-Circuit
 *COM
 *Voltage Set Point: 14.3V
 *Requires COM01 test adaptor for testing

Replaces

BOSCH : F-00M-145-285

Unit No.

BOSCH : 0-124-525-042

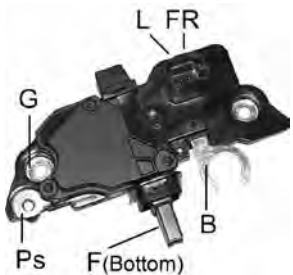
**VR-B295**

* Soft Start
 * 2.5 sec. LRC
 * Short Circuit Protection
 * Voltage Set Point: 14.5V

Replaces

BOSCH : F-00M-145-295,F-00M-145-375

Unit No.

BOSCH : 0-124-525-049,0-124-525-135...

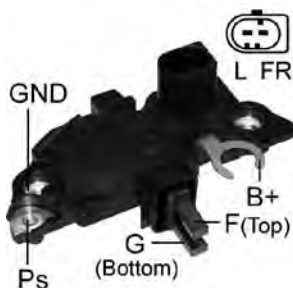
**VR-B296**

*B-Circuit
 *Soft Start
 *2.5 Second LRC
 *Short Circuit Protected
 *Voltage Set Point:14.6V

Replaces

BOSCH : F-00M-145-261,F-00M-145-296,F-00M-145-341...
VOLKSWAGEN : 06F903803,06F903803A,06F903803AX...

Unit No.

BOSCH : 0-124-215-008,0-124-325-044...

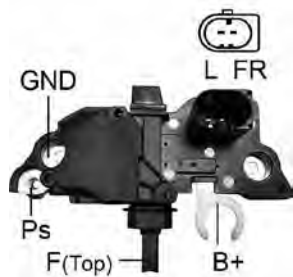
**VR-B300****Replaces**

BOSCH : F-00M-A45-300,F-00M-144-175,F-00M-145-891...

Unit No.

BOSCH : 0-124-315-037,0-124-325-126...

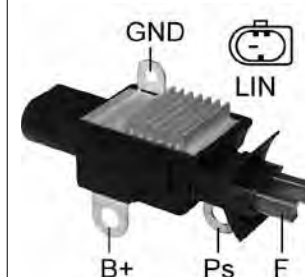
**VR-B3010**

*B-Circuit
 *Voltage Set Point: 14.3V
 *LIN
 *9600 & 19200 Baud Rate (4 Byte)

Replaces

BOSCH : 0-272-223-010

Unit No.

BOSCH : 0-126-312-014, 0-126-312-016

PICTURE
 IS NOT
 AVAILABLE

VR-B3102**Replaces**

BOSCH : 0-272-223-102,0-272-223-105

Unit No.

BOSCH : 0-126-312-006

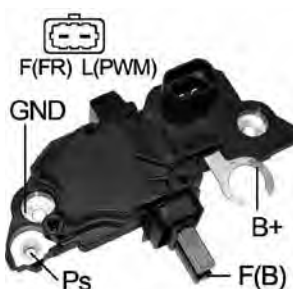
**VR-B314**

*B-Circuit
 *Voltage Set Point: 13.8V
 *Soft Start
 *2.5 sec. LRC
 *Short Circuit Protection
 *Regulated Voltage Control(RVC)
 *Requires VR-RVC01 test adaptor for testing

Replaces

BOSCH : F-00M-145-314,F-00M-145-328,F-00M-145-696

Unit No.

BOSCH : 0-124-425-032,0-124-425-049...
GM : 10335497,10366269,15233597

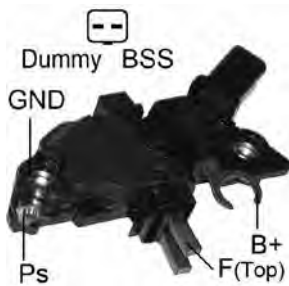
**VR-B322**

- *B-Circuit
- *BSS 3 Connections
- *Requires COM01 test adaptor for testing
- *ID Code: 22

Replaces

BOSCH : F-00M-145-322

Unit No.

BOSCH : 0-124-525-063

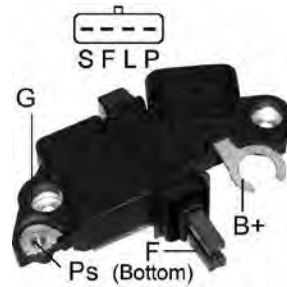
**VR-B330**

- *B-Circuit
- *Soft Start
- *2.5 sec. LRC
- *Short Circuit Protection
- *Voltage Set Point: 14.7V

Replaces

BOSCH : F-00M-145-330

Unit No.

BOSCH : 0-124-325-134

PICTURE
IS NOT
AVAILABLE

VR-B340**Replaces**

BOSCH : F-00M-346-340,F-00M-346-102,F-00M-346-011...

Unit No.

BOSCH : 0-121-715-101,0-121-715-001

**VR-B360**

- *A-Circuit
- *Soft Start
- *10 sec. LRC
- *Short Circuit Protection
- *Voltage Set Point: 14.5V

Replaces

BOSCH : F00M145251,F00M145254,F00M145360,F00MA45236

Unit No.

BOSCH : 0-124-515-050

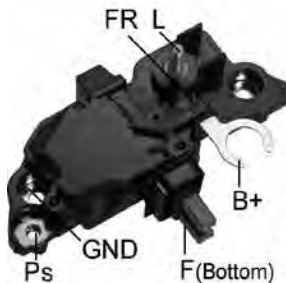
**VR-B363**

- *A-Circuit
- *Active Lamp
- *Soft Start
- *5.0 sec. LRC
- *Short Circuit Protection
- *Self-Exciting
- *Voltage Set Point: 14.3V

Replaces

BOSCH : F-00M-145-363,F-00M-144-140,F-00M-145-260...
MERCEDES-BENZ : 0031545606,0031542906,0031549106

Unit No.

BOSCH : 0-124-325-046,0-124-325-105...
MERCEDES-BENZ : 0111547402,0121541702,0121542202...

**VR-B369**

- *B-Circuit
- *Soft Start
- *5 sec. LRC
- *Short Circuit Protection
- *Voltage Set Point: 14.6V

Replaces

BOSCH : F00M145369,F00M145279,F00MA45211

Unit No.

BOSCH : 0-124-625-001,0-124-625-003
VOLVO : 8602713,8602714,8637849,8651665,8676499

**VR-B371**

- *A-Circuit
- *Soft Start
- *10 Second LRC
- *Short Circuit Protected
- *Voltage Set Point: 14.5V

Replaces

BOSCH : F00M145228,F00M145283,F00M145364,F00M145371...
GM : 93173428,93176049

Unit No.

BOSCH : 0-124-415-009,0-124-415-025...

**VR-B372**

- *A-Circuit
- *Soft Start
- *2.5 Second LRC
- *Short Circuit Protection
- *Voltage Set Point: 14.5V

Replaces

BOSCH : F-00M-145-226
OPEL : 12793278

Unit No.

BOSCH : 0-124-425-031,0-124-425-033...



VR-B378

- *B-Circuit
- *Voltage Set Point: 14.1V
- *LIN 1-1
- *19200 Baud Rate (4 Byte)
- *Requires COM01 test adaptor for testing
- *ID Code: 32

Replaces

BOSCH : F-00M-145-378,F-00M-145-886,F-00M-145-852...

Unit No.

BOSCH : 0-124-625-023
CHRYSLER : 68011841AA,68011841AB
MERCEDES-BENZ : 272-154-01-02,A272-154-01-02

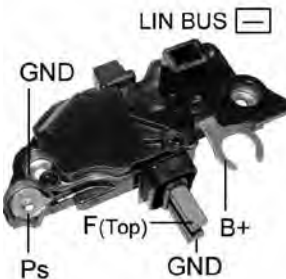

VR-B379

- *B-Circuit
- *Voltage Set Point: 13.8V
- *LIN-1
- *9600 Baud Rate (4 Byte)
- *Requires COM01 test adaptor for testing
- *ID Code: 88

Replaces

BOSCH : F-00M-145-311,F-00M-145-379,F-00M-A45-212

Unit No.

BOSCH : 0-986-047-380,0-124-625-024...
VOLVO : 30658086,30667893,8603264,30658084...



VR-B385

- *A-Circuit
- *BSS 3 Connections
- *Requires COM01 test adaptor for testing
- *ID Code: 12

Replaces

BOSCH : 0-031-543-706,0-031-545-806,F-00M-145-293...

Unit No.

BOSCH : 0-124-615-028,0-124-515-198
MERCEDES : A2711540802



VR-B391

- *A-Circuit
- *For 28mm OD slip ring
- *Voltage Set Point:14.4V

Replaces

BOSCH : 9-190-067-016,9-190-067-017,9-190-067-019...
FORD : E9JY-10316A
MOTORCRAFT : GRE802

Unit No.

BOSCH : 9-120-060-009,9-120-060-020
FORD : 89JA-10300AA,E9JY-10346A



VR-B392

- *A-Circuit
- *For 28mm OD slip ring
- *Soft Start
- *short Circuit Protection
- *Voltage Set Point:14.2V

Replaces

BOSCH : 9190067018

Unit No.

BOSCH : 9-120-060-023



VR-B393

- *A-Circuit
- *For 28mm OD slip ring
- *Voltage Set Point:14.4V

Replaces

BOSCH : 9-191-067-043

Unit No.

BOSCH : 9-120-061-100



VR-B394

- *A-Circuit
- *Soft Start
- *10 Second LRC
- *Short Circuit Protected
- *Voltage Set Point:14.5V

Replaces

BOSCH : F00M255200,F00M255201,F00M255202,F00M255200

Unit No.

BOSCH : 0-122-468-015

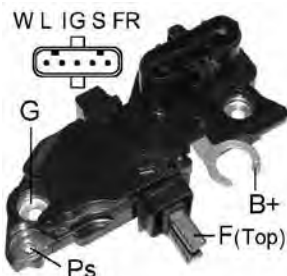
**VR-B396**

- *B-Circuit
- *Soft Start
- *0.5 sec. LRC
- *Short Circuit Protection
- *Loss of Sense Lamp Off
- *Voltage Set Point:28.3V

Replaces

BOSCH : F-00M-145-256,F-00M-145-298,F-00M-145-302...
DAF : 1600348
MERCEDES-BENZ : 1542405,1542406,1542605,1542705
SCANIA : 1501245,1501246,1502245
VOLKSWAGEN : 2TB903803A

Unit No.

BOSCH : 0-124-355-001,0-124-355-002...
MERCEDES-BENZ : 0001542605,0001542705,0031542606
SCANIA : 1501245,1502245
VOLKSWAGEN : 2TB903803A

**VR-B414**

- *A-Circuit
- *Active Lamp
- *Soft Start
- *2.5 sec. LRC
- *Short Circuit Protection
- *Voltage Set Point:14.3V

Replaces

BOSCH : F-00M-144-143,F-00M-145-287,F-00M-145-372
MERCEDES-BENZ : 31546006

Unit No.

BOSCH : 0-124-325-077,0-124-615-025...

**VR-B4197**

- *B-Circuit
- *LIN 1-1
- *19200 Baud Rate(4 bytes)
- *Voltage Set Point: 14.1V
- *ID Code: 24

Replaces

BOSCH : F-00M-144-197,
F00M 144 151

Unit No.

BOSCH : 0-124-525-200,
0-124-525-113

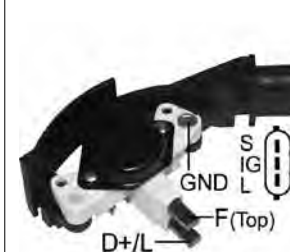
**VR-B510**

- *A-Circuit
- *Active Lamp
- *Voltage Set Point:14.4V

Replaces

BOSCH : 1-197-311-510

Unit No.

BOSCH : 0-123-325-002,0-123-325-012...
TOYOTA : 27060-02100

**VR-B5204**

- *A-Circuit
- *BSS Connections
- *ID Code: 54

Replaces

BOSCH : F-00M-255-204

Unit No.

BMW : 12-31-7-507-741,12-31-7-507-995
BOSCH : 0-122-0AA-090

**VR-B543B**

- *24V
- *B-Circuit
- *Voltage Set Point: 28.4V

Replaces

BOSCH : 1197311543,123500520
IVECO : 42532975

Unit No.

BOSCH : 0-123-525-500,0-123-525-502

**VR-B558B**

- *B-Circuit
- *L Terminal Drive Choke
- *Soft Start
- *Short Circuit Protection
- *Voltage Set Point:25.6V

Replaces

BOSCH : 1-197-311-558
MAN : 81256010025

Unit No.

BOSCH : 0-123-325-500,0-123-525-501

**VR-B6151**

- *B-Circuit
- *LIN
- *19200 & 9600 Baud Rate (4 Byte)
- *Voltage Set Point: 14.3V

Replaces

BOSCH : F-00M-346-151

Unit No.

BOSCH : 0-125-711-030

**VR-B6164**

*LIN 1-1
 *9600&19200 Baud Rate (4 Byte)
 *Requires COM01 test adaptor for testing
 *Voltage Set Point: 14.3V
 *ID Code: 64

Replaces

BOSCH : F-00M-346-164,F-00M-346-152,F-00M-346-163
VOLKSWAGEN : 06H903803B,06H903803D

Unit No.

BOSCH : 0-125-711-090

PICTURE IS NOT AVAILABLE

VR-B657**Replaces**

BOSCH : F-00M-145-881

Unit No.

BOSCH : 0-124-525-083

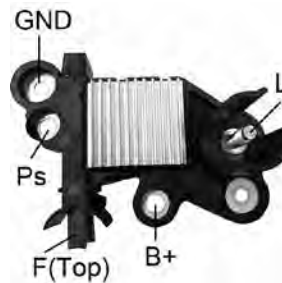
**VR-B703**

*B-Circuit
 *Soft Start
 *2.5 sec. LRC
 *Short Circuit Protection
 *Voltage Set Point: 14.5V

Replaces

BOSCH : 0-272-220-703

Unit No.

BOSCH : F-000-BL0-740
FIAT : 51905540

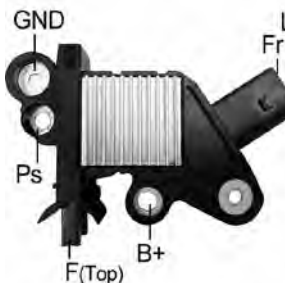
**VR-B704**

*B-Circuit
 *Soft Start
 *2.5 sec. LRC
 *Short Circuit Protection
 *Voltage Set Point: 14.5V

Replaces

BOSCH : 0-272-220-704
FIAT : 77365937

Unit No.

BOSCH : F-000-BL0-633,F-000-BL0-605...

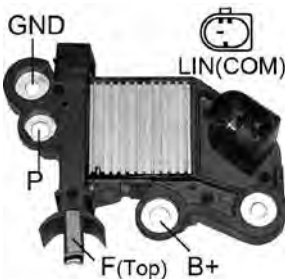
**VR-B807**

*B-Circuit
 *LIN
 *9600 & 19200 Baud Rate (4 Byte)
 *Voltage Set Point: 14.3V
 *ID Code: 64

Replaces

BOSCH : 0-272-220-807
VOLKSWAGEN : 06H 903 803 E

Unit No.

AUDI : 06E903019D,06E903019DX,059903019N...
BOSCH : 0-125-711-124,0-125-711-149...

**VR-B822**

*Voltage Set Point: 14.3V
 *LIN
 *19200 Baud Rate (4 Byte)
 *Requires COM01 test adaptor for testing
 *ID Code:80

Replaces

BOSCH : 0-272-220-822

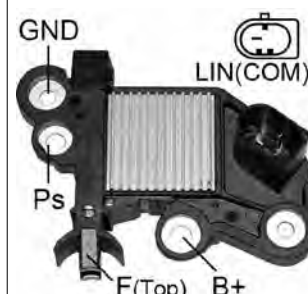
**VR-B823**

*B-Circuit
 *Voltage Set Point: 13.7V
 *LIN 2.1
 *19200 Baud Rate (4 Byte)
 *ID Code: 88

Replaces

BOSCH : 0-272-220-823

Unit No.

BOSCH : 0 125 711 041,0 125 812 012...

**VR-B827**

*Voltage Set Point: 14.3V
 *LIN 2.1
 *19200 Baud Rate (4 Byte)
 *ID Code: 48

Replaces

BOSCH : 0-272-220-827

Unit No.

BOSCH : F-000-BL0-825,F-000-BL0-8E0...
NISSAN : 23100-4EA0A

**VR-B835**

*B-Circuit
 *Voltage Set Point: 14.3V
 *LIN
 *19200 Baud Rate
 *Requires COM01 test adaptor for testing
 *ID Code: 16

Replaces

BOSCH : 0-272-220-835
Unit No.
BOSCH : 0-125-811-054

**VR-B839**

*B-Circuit
 *Voltage Set Point: 14.3V
 *LIN
 *19200 Baud Rate
 *ID Code: 24

Replaces

BOSCH : 0-272-220-839,0-272-220-809
Unit No.
BOSCH : 0-125-812-009,0-125-711-030...
MERCEDES : A0009060022,A0009061903
VOLVO : 30659580,36002812

**VR-B840**

*B-Circuit
 *Voltage Set Point: 14.3V
 *LIN 2.1
 *19200 Baud Rate (4 Byte)

Replaces

BOSCH : 0-272-220-840

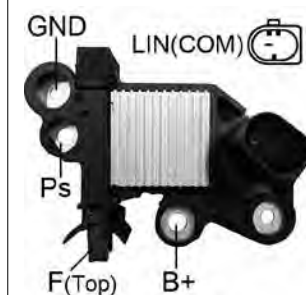
**VR-B842**

*Voltage Set Point: 14.3V
 *LIN
 *19200 Baud Rate (4 Byte)
 *Requires COM01 test adaptor for testing
 *ID Code: 16

Replaces

BOSCH : 0-272-220-842
Unit No.
BOSCH : F-000-BL0-797

**VR-B843**

*Voltage Set Point: 14.3V
 *LIN
 *19200 Baud Rate (4 Byte)
 *Requires COM01 test adaptor for testing
 *ID Code: 32

Replaces

BOSCH : 0-272-220-843

**VR-B854**

*Voltage Set Point: 14.3V
 *LIN
 *19200 Baud Rate (4 Byte)
 *Requires COM01 test adaptor for testing
 *ID Code: 24

Replaces

BOSCH : 0-272-220-854,0-272-220-824,0-272-220-804
Unit No.
AUDI : 04C903023L,06J903023G,04E903023J...
BOSCH : F-000-BL0-805,F-000-BL0-802...

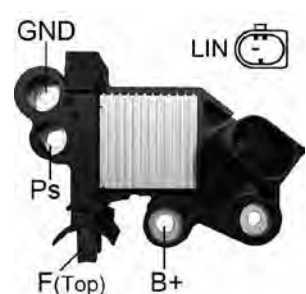
**VR-B855**

*B-Circuit
 *Voltage Set Point: 14.3V
 *LIN
 *19200 Baud Rate (4 Byte)

Replaces

BOSCH : 0-272-220-855

Unit No.

BOSCH : 0-125-811-033,
 0-125-811-035...

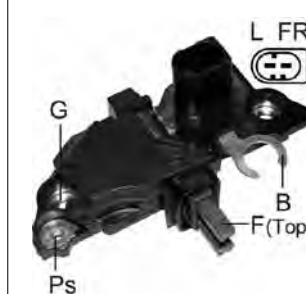
**VR-B861**

*B-Circuit
 *Soft Start
 *Short Circuit Protection
 *Voltage Set Point: 14.5V

Replaces

BOSCH : F-00M-145-340,F-00M-145-861

Unit No.

BOSCH : 0-124-625-007,
 0-124-515-055...

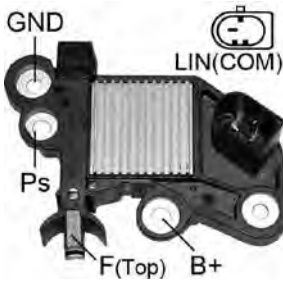
**VR-B867**

- *B-Circuit
- *Voltage Set Point: 13.7V
- *LIN
- *9600 Baud Rate (4 Byte)
- *Requires COM01 test adaptor for testing
- *ID Code: 88

Replaces

BOSCH : 0 272 220 867

Unit No.

BOSCH : 0 125 711 131,0 125 711 132...

**VR-B880**

- *B-Circuit
- *COM
- *BSS 3 Connections
- *Voltage Set Point: 14.3V
- *Requires COM01 test adaptor for testing
- *ID Code: 20

Replaces

BOSCH : F-00M-145-880,F-00M-145-262,F-00M-A45-221...

Unit No.

BMW : 12317521384,12317521490,12317521491...
BOSCH : 0-124-525-045,0-124-525-059...

**VR-B883**

- *A-Circuit
- *Soft Start
- *5.0 sec. LRC
- *Short Circuit Protection
- *Voltage Set Point:14.0V

Replaces

BOSCH : F-00M-145-266,F-00M-145-365,F-00M-145-883
MERCEDES-BENZ : 0031545706

Unit No.

BOSCH : 0-124-625-019,0-124-525-161...

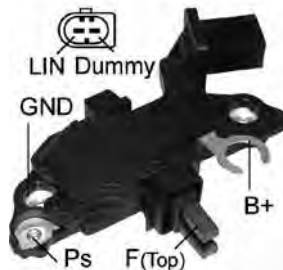
**VR-B885**

- *B-Circuit
- *Voltage Set Point: 14.2V
- *LIN
- *19200 Baud Rate (4 Byte)
- *Requires COM01 test adaptor for testing
- *ID Code: 24

Replaces

BOSCH : F-00M-144-157,F-00M-145-309,F-00M-145-377...
MERCEDES-BENZ : 0031546106

Unit No.

BOSCH : 0-124-525-054,0-124-525-055...
MERCEDES : 0141543702,2721540002,6361540102...

**VR-B903**

- *B-Circuit
- *Voltage Set Point: 13.7V
- *LIN 2
- *19200 Baud Rate (4 Byte)

Replaces

BOSCH : 0-272-220-903

Unit No.

BOSCH : F-000-BL0-7Z9

Brush Holder

Voltage Regulator

Repair Circuit

Rectifier

Diode Trio

Diode

Tester



VR-C524
 *Electronic type
 *Voltage Set Point:14.5V

Replaces
CHRYSLER : 1889960,2095700,2098300,3000074,CH524

Unit No.
CHRYSLER : 2095000,2095060,2095100,2095300,2095425...



VR-C545
 *Voltage Set Point:14.7V

Replaces
CHRYSLER : 3438150,3755850,3755960,3874520





Unit No.
CHRYSLER : 3237797,3438846,3438847,3656570,3755585...



VR-C545H
 *Heavy Duty
 *Voltage Set Point: 14.7V

Replaces
CHRYSLER : 3438150,3755850,3755960,3874520,3755970...

Unit No.
CHRYSLER : 3237797,3438846,3438847,3656570,3755585...

 <p>VR-D271 *Voltage Set Point:14.6V Replaces DAEWOO : 271910,93740796 Unit No. DAEWOO : 219170,96380673</p>	 <p>VR-D276 *Voltage Set Point:14.7V Replaces DAEWOO : 276010 DELCO : 276010 Unit No. DAEWOO : 96303556</p>
 <p>VR-K03 *Voltage Set Point: 14.4V Unit No. DAEWOO : 31410-A80D00</p>	 <p>VR-K04 *Voltage Set Point: 14.6V Replaces DAEWOO : DAD25006D Unit No. DAEWOO : 31400-A78B02,31400-A78-130</p>
 <p>VR-K06B *24V *Has an internal diode *Voltage Set Point: 28.8V Unit No. DELCO : A124041,A134153,390104</p>	

- Brush Holder
- Voltage Regulator
- Repair Circuit
- Rectifier
- Diode Trio
- Diode
- Tester

Brush Holder

Voltage Regulator

Repair Circuit

Rectifier

Diode Trio

Diode

Tester

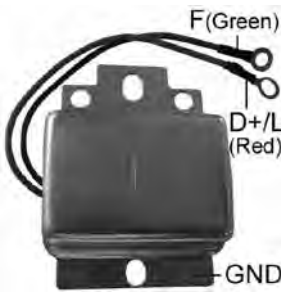

VR-D001B
 *24V
 *Voltage Set Point:28.2V
Replaces
CATERPILLAR : 2P1699
PRESTOLITE : 8393,8-394,VSH-6401ES ,8-393,8-394...
Unit No.
PRESTOLITE : ANB7001, ANB7002,ANB7003,ANB7004



VR-D100
 *Voltage Set Point:14.3V
Replaces
DELCO : 94652566



VR-D1033
 *Self Exciting
 *Short Circuit Protection
 *Voltage Set Point: 14.2V
Replaces
DELCO : 10521033
Unit No.
DELCO : 8600310,8600889



VR-D186
 *B-Circuit
 *Inactive Lamp
 *Soft Start
 *2.5 sec. LRC
 *Voltage Set Point:13.8V
Replaces
DELCO : 222727
Unit No.
DELCO : 13579662,13500186



VR-D231
 *Soft Start
 *8.5 sec. LRC w/open sense indication
 *Short Circuit Protection
 *Voltage Set Point:14.8V
Replaces
DELCO : 10458198,10453673,10483777,10483778
Unit No.
DELCO : 10464408,10464421,10464430,10464439...

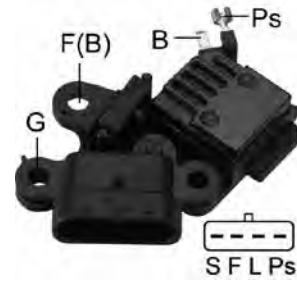

VR-D232
 *Soft Start
 *2.5 sec. LRC
 *Short Circuit Protection
 *Voltage Set Point:14.8V
Unit No.
DELCO : 10464406,10480327,10480341,3211750

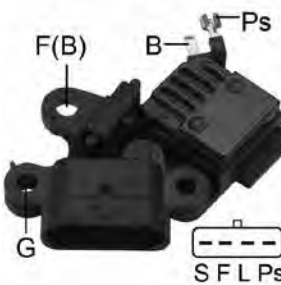

VR-D233
 *Voltage Set Point:14.8V
 *2.5 sec. LRC w/open sense indication
Replaces
DELCO : 10458202,15063025,15163024
Unit No.
DELCO : 10464459,10464460,10464483,10464484...

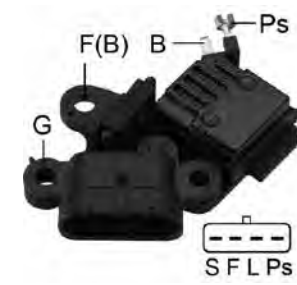

VR-D234
 *Voltage Set Point:14.8V
 *8.5 sec. LRC
Replaces
DELCO : 10484046
Unit No.
DELCO : 10480368,10480428

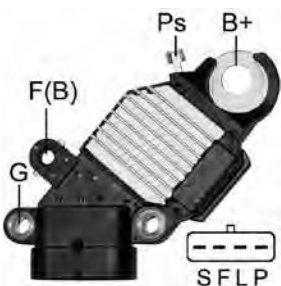

VR-D235
 *S-F-L-P Terminals
 *B-Circuit
 *Inactive Lamp
 *Soft Start
 *2.5 sec. LRC
 *Short Circuit Protection
 *Lamp off when S Open
 *Voltage Set Point:14.8V

Replaces
DELCO : 19060319,19060345
Unit No.
DELCO : 10464476,15226003,15754097,15754097A...

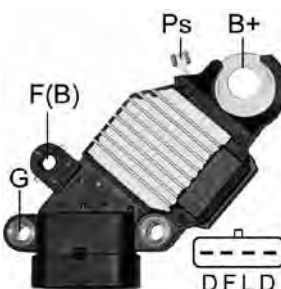

VR-D235SE
 *With Self-Exciting
 *B-Circuit
 *Voltage Set Point:14.6V

Replaces
DELCO : 10483643,10486311,19053013,19053730,19054622...

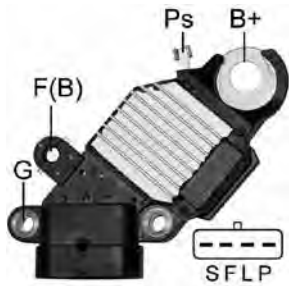

VR-D238

- *B-Circuit
- *Inactive Lamp
- *Soft Start
- *8.5 sec. LRC
- *Short Circuit Protection
- *S Open Lamp On
- *S-F-L-P Terminals
- *Voltage Set Point:14.8V

Replaces

DELCO : 10453673,10458198,10483777,10483778



VR-D282

- *S-F-L-P Terminals
- *B-Circuit
- *Inactive Lamp
- *Self Exciting
- *Short Circuit Protection
- *Lamp off when S Open
- *Voltage Set Point:14.3V

Replaces

DELCO : 10527282

Unit No.

DELCO : 8600201



VR-D295

- *Self Exciting
- *Short Circuit Protection
- *Voltage Set Point:14.2V

Replaces

DELCO : 10529295

Unit No.

DELCO : 8600094,8600279,8600280,8600288,8600289



VR-D298

- * C-Fr-D-L Terminals
- * Voltage Set Point: 14.4V
- * Soft Start
- * Short Circuit Protection

Unit No.

DELCO : 8400206
HYUNDAI : 37300-3C610
KIA : 37300-3C610

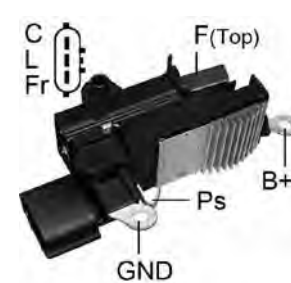

VR-D299

- * C-Fr-L Terminals
- * Voltage Set Point: 14.3V
- * Soft Start
- * Short Circuit Protection

Unit No.

DELCO : 8400320
HYUNDAI : 37300-2E700

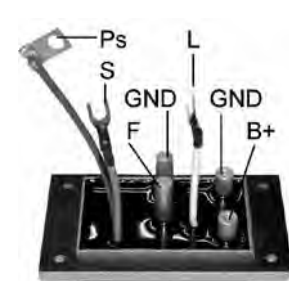

VR-D406B

- *Voltage Set Point: 27.9V

Replaces

DELCO : 19020406



VR-D412

- *P-L-F-S Terminals
- *Soft Start
- *8.5 sec LRC
- *Short Circuit Protection
- *Voltage Set Point:14.6V

Unit No.

DELCO : 1116412,19009712



VR-D424

- *L Terminal Drives Choke
- *Soft Start
- *Voltage Set Point:14.7V

Replaces

DELCO : 1116424

Unit No.

DELCO : 1101199,1101551

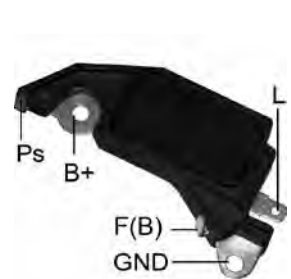

VR-D432

- *L Terminal Drives Choke
- *Soft Start
- *Voltage Set Point:14.7V

Replaces

DELCO : 1116432

Unit No.

DELCO : 1101816



VR-D440

- *L Terminal Drives Choke
- *Soft Start
- *Voltage Set Point:14.7V

Replaces

DELCO : 1116440

Unit No.

TOYOTA : 27060-02050,27060-74200

**VR-D445**

- *B-Circuit
- *Inactive Lamp
- *Soft Start
- *8.5 sec. LRC
- *Short Circuit Protection
- *S-F-L-Ps Terminals
- *With Instrument Cluster Gauges
- *Voltage Set Point:14.6V

Replaces

DELCO : 1116445

Unit No.

DELCO : 10480055,10480227,10480265,10480278...

Brush Holder

**VR-D481****Replaces**

DELCO : 10459481,10459482,10459483,10459596,15095471...

GM : 19116396

**VR-D502**

- *Soft Start
- *2.5 sec. LRC
- *Short Circuit Protection
- *Voltage Set Point: 14.5V

Replaces

DELCO : 220116

SSANGYONG : 66215-43006

Unit No.

SSANGYONG : 66215-45102,66215-45502

Voltage Regulator

**VR-D579H**

- *Soft Start
- *2.5 sec. LRC
- *Short Circuit Protection
- *S Open Lamp Off
- *Voltage Set Point: 14.6V

Replaces

DELCO : 10503579

Unit No.

DELCO : 15200109,15845337,15845338,15847291

PICTURE IS NOT AVAILABLE

VR-D580**Unit No.**

DELCO : 13502580

Repair Circuit

**VR-D583**

- *Soft Start
- *2.5 sec. LRC
- *Short Circuit Protection
- *Voltage Set Point: 13.8V
- *Regulated Voltage Control(RVC)
- *Requires RVC01 tester box for testing

Unit No.

DELCO : 13500582,13579663,13500577,13579666...

Rectifier

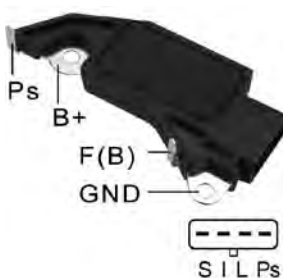
**VR-D602H**

- *B-Circuit
- *Inactive Lamp
- *Soft Start
- *8.5 sec. LRC
- *Short Circuit Protection
- *S-I-L-Ps Terminals
- *Voltage Set Point:14.6V

Replaces

DELCO : 1116446,D602A

Unit No.

DELCO : 10480135,10480171,CS144

Diode

**VR-D635**

- *Electronic Type
- *Voltage Set Point:14.5V

Replaces

DELCO : 1119506,1119512,1119515,1119519,D635,D663

Unit No.

DELCO : 1100553,1100557,1100558,1100566,1100567...

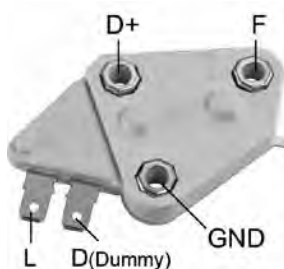
**VR-D668B**

- *24V
- *For use on One wire hook-up,
- *low cut-in,Agricultural,
- *Industrial and Marine Application
- *Voltage Set Point:28.0V

Replaces

DELCO : 234060

Tester

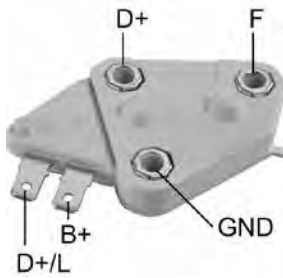
**VR-D668C**

*VR-D668CL (Volts setting 14.2V)

*For use on Delco 10, 12&15SI Alternators
*Voltage Set Point:14.7V

Replaces

AMC : 8125176
BOSCH : 0-986-192-000
DELCO : 1116380,1116384,1116385,1116387,1116387H...
LUCAS : 21226042,UCB701
MOTORCRAFT : GR307
OPEL : 1204236

Unit No.

DELCO : 10456313,10479850,10479925,10497083...

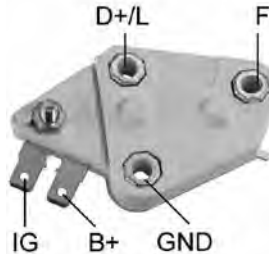
**VR-D669C**

*For use on Delco 10SI type 116, 20SI, 27SI type 200

*For use on Delco 30 & 40SI
*Voltage Set Point:14.2V

Replaces

DELCO : 1116360,1116389,1116390,13001740,1876388...
MOTORCRAFT : GR536

Unit No.

DELCO : 10459017,10459036,1117160,1117163...

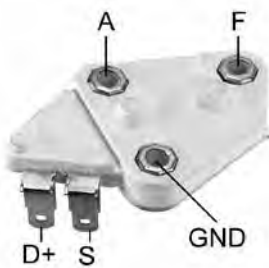
**VR-D670C**

*For use on Opel, Triumph, Vauxhall

*Voltage Set Point:14.7V

Replaces

DELCO : 7934605,7934614,7982866
LUCAS : 21226041,UCB700
OPEL : 1204245

**VR-D671C**

*For use on:
*Austin,Princess,Commer,Leyl and,MG,MGB8,Vauxhall,Opel
*Voltage Set Point:14.7V

Replaces

DELCO : 21226043,7982685
LUCAS : UCB702
MAGNETI MARELLI : 940038033

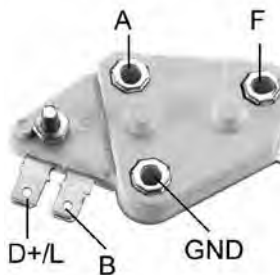
**VR-D672C**

*24V
*For use on Delco 20SI Type 200, 29SI & 30SI
*Voltage Set Point:27.5V

Replaces

CATERPILLAR : 3T6353,3T6354,6N1874,7N7799,9N1207
DELCO : 1105510,1116388,1984287

Unit No.

DELCO : 10SITYPE116,1103123,1105475,1987518...

**VR-D673C**

*For use on Opel, Vauxhall
*Voltage Set Point:14.7V

Replaces

BOSCH : 0-986-192-015
DELCO : 13472557,3472557,3493050
DELCO REMY (LUCAS) : 21226104
GM : 3474557
LUCAS : UCB703
MAGNETI MARELLI : 940038032
OPEL : 1204248
VALEO(DUCCELLIER) : 592983

Unit No.

DELCO : 3472020,3472021,3472023,3472028,3472032...

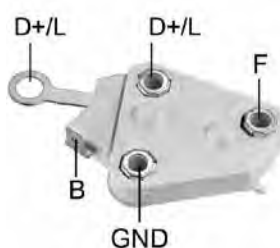
**VR-D674**

*VR-D674 For 5A. Field
*For use on OPEL, VAUXHALL
*Voltage Set Point:14.8V

Replaces

DELCO : 3493029,3493030,3493079,3493080
LUCAS : UCB705
OPEL : 1204257,1204258,1204263,1204264
VALEO : A564796A

Unit No.

DELCO : 3472104,3472105,3472106,3472119,3472120...

Brush Holder

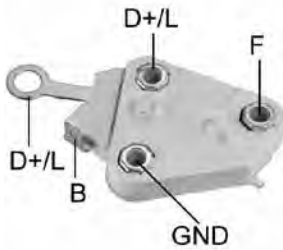

VR-D674H

*For 8A. Field
 *For use on OPEL,
 VAUXHALL
 *Voltage Set Point:14.8V

Replaces

DELCO : 3293030,3493029,3493079,3493080
 LUCAS : UCB705
 OPEL : 1204257,1204258,1204263,1204264
Unit No.
 DELCO : 3472104,3472105,3472106,3472119,3472120...

Voltage Regulator



VR-D675H

*B-Circuit
 *Inactive Lamp
 *Soft Start
 *2.5 sec. LRC
 *Short Circuit Protection
 *S-F-L-Ps Terminals
 *Voltage Set Point:14.6V

Replaces

DELCO : 1116408,1116428,D675,D699
Unit No.
 DELCO : CS130,CS144

Repair Circuit

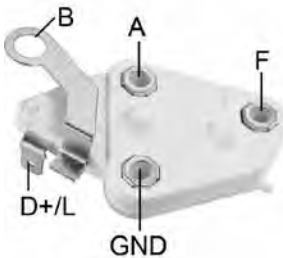

VR-D676

*For use on OPEL,
 VAUXHALL
 *Voltage Set Point:14.7V

Replaces

DELCO : 9315303,9345333
 LUCAS : UCB704
 VALEO(DUCELLIER) : 592984

VR-D677

*Voltage Set Point:14.7V

Replaces

DELCO : 1988988,D674
Unit No.
 DELCO : 10479930,10497082,
 1101134,1101215...

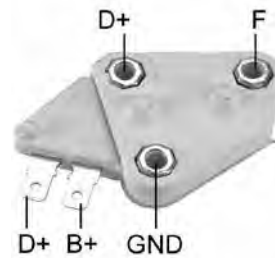

Rectifier

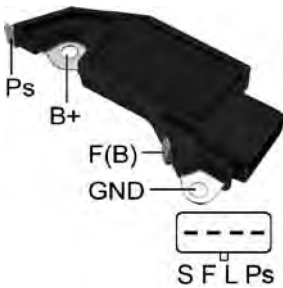

VR-D678H

*P-L-F-S Terminals
 *Soft Start
 *10 Second LRC
 *Short Circuit Protected
 *Voltage Set Point:14.2V

Replaces

DELCO : D678,D684
Unit No.
 DELCO : 10480018,10480019,10
 480120,1101133...

VR-D679SE

*Self Exciting
 *Voltage Set Point:14.8V



Diode Trio

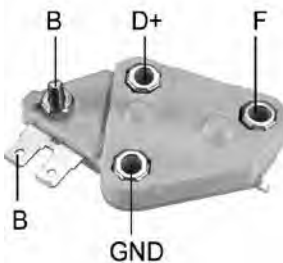

VR-D680

*For use on Delco 20SI, 21SI,
 26SI
 *With Webbed Terminals
 *Voltage Set Point:14.0V

Replaces

DELCO : 1116433,1116435,1116442,
 6159599,D686,DVR202
Unit No.
 DELCO : 10459017,10459036,1117160,1117163...

Diode

Tester



VR-D681H

*B-Circuit
 *Inactive Lamp
 *Soft Start
 *8.5 sec. LRC
 *Short Circuit Protection
 *S-F-L-Ps Terminals
 *With Instrument Cluster
 Gauges
 *Voltage Set Point:14.6V

Replaces

DELCO : 1116413,1116430,D600A,D681
Unit No.
 DELCO : 10463096,10463108,10463119,10463121...

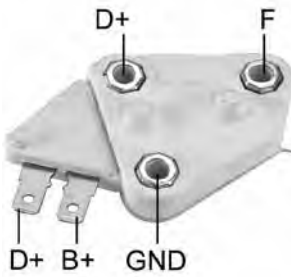

VR-D682
 *For Use on: Delco 21SI
 Alternators
 *Voltage Set Point:14.0V
Replaces
DELCO :
 1116438,1116439,1116441
Unit No.
DELCO :1117926,1117936,
 1117939,1117940

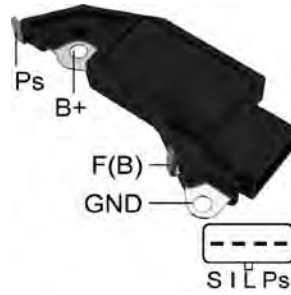

VR-D683H
 *S-I-L-Ps Terminals
 *Soft Start
 *2.5 Second LRC
 *Short Circuit Protected
 *Voltage Set Point:14.2V
Replaces
DELCO : 1116425,D683
Unit No.
DELCO : 10479852,10479959,
 10479976,1101482...

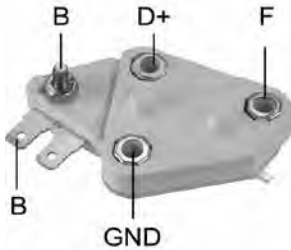

VR-D686
 *For Use On: Delco 10SI,
 20SI, 21SI, 26SI,29SI & 30SI
 *With Webbed Terminals
 *Voltage Set Point:14.2V
 *Heavy Duty Version

Replaces
DELCO : 1116406,1116407,1116435,1894489,D672
Unit No.
DELCO : 10459017,10459036,1117160 ,1117163 ...

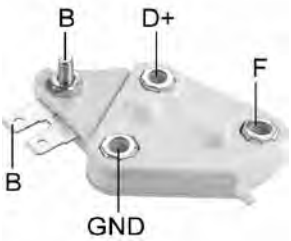

VR-D687
 *24V
 *For Use On: Delco 10SI Type
 116, 20SI, 27SI Type 200,
 *29SI & 30SI
 *With Webbed Terminals
 *Voltage Set Point:27.5V

Replaces
DELCO : 1116388,1987518
Unit No.
DELCO : 10SITYPE116,1100077,1100211,1101285...

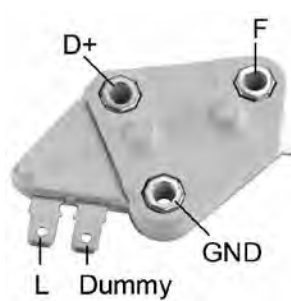

VR-D689
 *Agricultural, Industrial &
 Marine Applications Self
 Exciting
 *For 12V Systems One Wire
 Hook-up
 *Voltage Set Point:14.7V

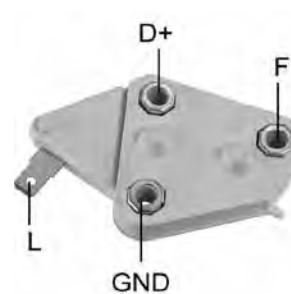

VR-D690
 *A-Circuit
 *Inactive Lamp
 *Voltage Set Point:14.7V
Replaces
CATERPILLAR : 9L6774
DELCO :
 94648534,1116433,1116435,
 1116442,D686,D687...

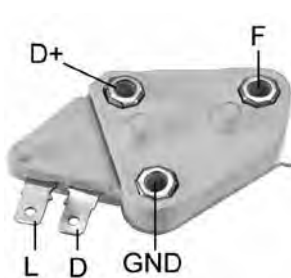

VR-D691
 *Self Exciting For 6V System
 *Agricultural, Industrial &
 Marine Applications
 *Voltage Set Point:7.8V
Replaces
DELCO : 234058

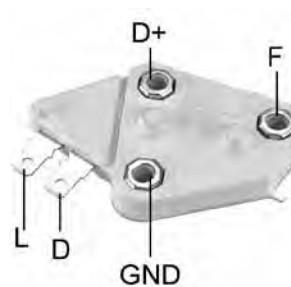

VR-D692
 *Self Exciting For 8V System
 *For use on: One wire
 hook-up,
 *low cut-in, Agricultural,
 Industrial and Marine
 Applications
 *Voltage Set Point:9.7V



VR-D694H
 *B-Circuit
 *Inactive Lamp
 *Soft Start
 *2.5 sec. LRC
 *Short Circuit Protection
 *S-I-L-Ps Terminals
 *Without Adapter Plug
 *Voltage Set Point:14.6V

Replaces
DELCO : 1116429,1116436,1116437,1116439,1116440,D677...
Unit No.
DELCO : 10479805,10480095,10480096,1101584...

Brush Holder



VR-D694HD
 *With Ridged Heat Sink
 *Without adapter plug
 *Voltage Set Point:14.6V
Replaces
 DELCO : 1116411,1116429,1116436,1116437,1116439...
Unit No.
 DELCO : 10479805,10480095,10480096,1101584...

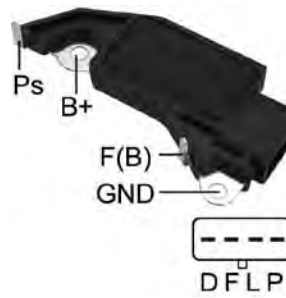

VR-D694SE
 *B-Circuit
 *D-F-L-P Terminals
 *Self Exciting
 *Voltage Set Point:14.6V
Replaces
 DELCO : 1116411,1116429,1116436,1116437,1116439...

Voltage Regulator



VR-D696B
 *Voltage Set Point:27.5V

Replaces
 DELCO : 1105510,1116388,1116404,1116405,1894460...
Unit No.
 DELCO : 102934,11000211,1100077,1100078,1101285...

Repair Circuit

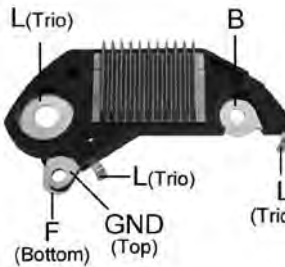

VR-D701
 *B+ - L Terminals
 *Voltage Set Point:14.6V

Replaces
 DELCO : 10475019,19009701,19009716
 GM : 140475019
 MAGNETI MARELLI : 940038030
 OPEL : 1204270
Unit No.
 DELCO : 10479914,10479923,10479947,10479955...
 GM : 3493814,3493823,3493847,3493855
 OPEL : 6204002,6204006,6204007,6204008

Rectifier



VR-D702H
 *B-Circuit
 *Inactive Lamp
 *Soft Start
 *2.5 sec. LRC
 *Short Circuit Protection
 *S-I-L-Ps Terminals
 *Voltage Set Point:14.6V

Replaces
 DELCO : 19009702,19009719
Unit No.
 DELCO : 10463663,10470119,10479981,10479984...
 OPEL : 3211008,3211023,3211025,3211026,3211027...

Diode Trio

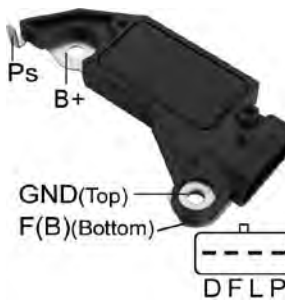

VR-D702SE
 *B-Circuit
 *D-F-L-D Terminals
 *D:Dummy
 *Self Exciting
 *Voltage Set Point:14.6V

VR-D703H
 *B-Circuit
 *Inactive Lamp
 *Soft Start
 *8.5 sec. LRC
 *Short Circuit Protection
 *S-I-L-Ps Terminals
 *Voltage Set Point:14.6V
Replaces
 DELCO : 19009703
Unit No.
 DELCO : 10480043,3211048

Diode

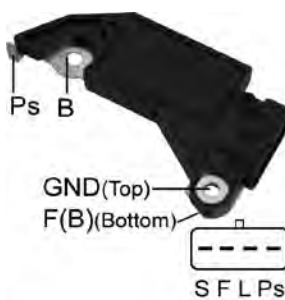

VR-D705H
 *B-Circuit
 *Inactive Lamp
 *Soft Start
 *8.5 sec. LRC
 *Short Circuit Protection
 *S-F-L-Ps Terminals
 *Voltage Set Point: 14.6V
Replaces
 DELCO : 19009705
Unit No.
 DELCO : 10480074,10480076,10480079

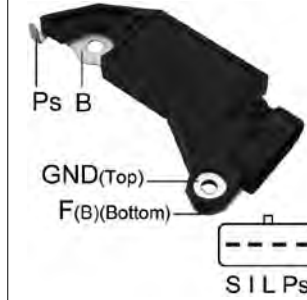

VR-D706H
 *B-Circuit
 *Inactive Lamp
 *P-L-I-S Terminals
 *Soft Start
 *2.5 Second LRC
 *Short Circuit Protected
 *Voltage Set Point:14.2V
Replaces
 DELCO : 19009706

Tester

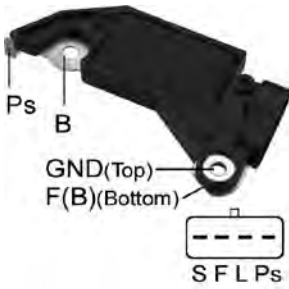

VR-D707

- *B-Circuit
- *Inactive Lamp
- *Soft Start
- *2.5 sec. LRC
- *Short Circuit Protection
- *P-L-F-S Terminals
- *Voltage Set Point:14.8V

Replaces

DELCO : 19009718,19009748

Unit No.

DELCO : 10464413,10464424,10464427,10464437...



VR-D709

- *B-Circuit
- *Inactive Lamp
- *Soft Start
- *8.5 sec. LRC
- *Short Circuit Protection
- *P-L-F-S Terminals
- *Voltage set point: 14.8V

Replaces

DELCO : 19009729

Unit No.

DELCO : 10464415,10464423,10464431,10464432...

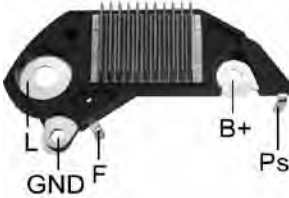

VR-D711

- *Soft Start
- *4.0 sec. LRC
- *Voltage Set Point:14.6V

Replaces

DELCO : 19009708,10493240

GM : 10493240

OPEL : 1204288

Unit No.

DELCO : 90543910

OPEL : 6204072

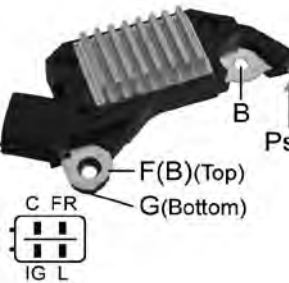

VR-D712

- *C-FR-IG-L
- *Soft Start
- *Short Circuit Protection
- *For use on Delco CS130D Series IR/IF Alternators
- *Voltage Set Point:14.8V

Replaces

DELCO : 19009715

HITACHI : TR1Z-125

Unit No.

DELCO : 10480228,10480497

HONDA : 31100-P8A-A01,31100-P8A-A02

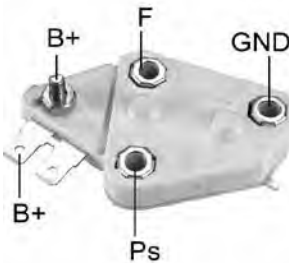

VR-D713

- *Self-Exciting
- *Voltage Set Point:14.6V

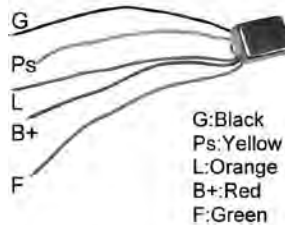

VR-D714SE

- *B-Circuit
- *PS open Lamp on
- *Voltage Set Point:14.2V

Replaces

DELCO : 235864



VR-D715

- *Voltage Set Point: 14.5V
- *Soft Start
- *2.5 sec. LRC
- *Short Circuit Protection

Unit No.

DELCO : 96408588



VR-D716

- *Voltage Set Point: 14.5V

Unit No.

GM : 96954112



VR-D717

- *A-Circuit
- *I-L Terminals
- *Inactive Lamp
- *Soft Start
- *2.5 sec. LRC
- *Short Circuit Protection
- *Voltage Set Point:14.5V
- *For use on Korean Delco Alternators

Unit No.

GM : 96540542,96838439

SUZUKI : 31400-85Z00

**VR-D719**

- *B-Circuit
- *Inactive Lamp
- *Soft Start
- *8.5 sec. LRC
- *Short Circuit Protection
- *Voltage Set Point:14.8V

Replaces

DELCO : 19009736,19009751

Unit No.

DELCO : 10480280,10480340

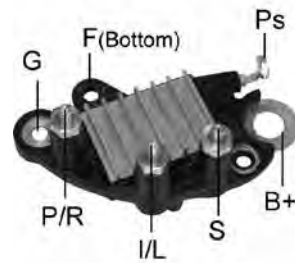
**VR-D720**

- *Self Exciting
- *Short Circuit Protection
- *Voltage Set Point:14.2V

Unit No.DELCO : 8600307,8600311,
8600313,8600314,8600316

PICTURE
IS NOT
AVAILABLE

VR-D737**Replaces**

GM : 220737

Unit No.

GM : 96991181,1925162

**VR-D740**

- *S-L Terminals
- *Voltage Set Point:14.6V

Replaces

DELCO : 271940

Unit No.DAEWOO : 266000
DELCO : 19020601,19020612,
19020609,19020611**VR-D744**

- *B-Circuit
- *Active Lamp
- *Soft Start
- *2.5 sec. LRC
- *Short Circuit Protection
- *Voltage Set Point:14.4V

Replaces

DELCO : 235542

ISKRA : 235542

Unit No.

DELCO : 10480403

MERCEDES-BENZ : 0001500850,0001501650,A0001500850...

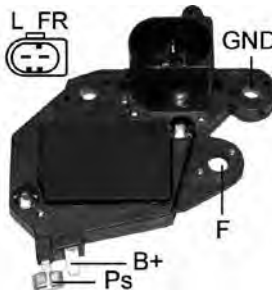
**VR-D745**

- *L-FR Terminals
- *Soft Start
- *6.0 sec. LRC
- *Short Circuit Protection
- *Self Exciting
- *Voltage Set Point:14.8V

Replaces

DELCO : 236563

MERCEDES-BENZ : A0001501750

Unit No.

DELCO : 10480407,10480404,10480408

MERCEDES-BENZ : 0001501750,0001502550,A0001501750...

**VR-D747HD**

- *Regitar No.:D747HD
- *Soft Start
- *2.5 sec. LRC
- *Short Circuit Protection
- *Voltage Set Point: 14.6V

Replaces

DELCO : 10494747,10458201

Unit No.

DELCO : 10480229

**VR-D755**

- *Voltage Set Point: 13.8V
- *Soft Start
- *2.5 sec. LRC
- *Short Circuit Protection
- *Regulated Voltage Control(RVC)
- *Requires RVC01 tester box for testing

Replaces

DELCO : 10517755

Unit No.

DELCO : 10392759,15093928,15200268,15263858...

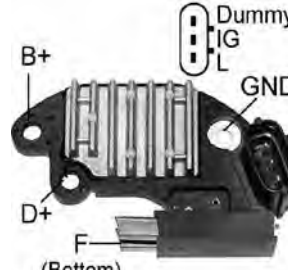
 <p>VR-Y002 *Soft Start *2.5 sec. LRC *Short Circuit Protection *Voltage Set Point: 14.2V</p> <p>Replaces DELCO : JFZ1621-530</p> <p>Unit No. DELCO : JFZ1621</p>	 <p>VR-Y015 *A-Circuit *Short Circuit Protection *Voltage Set Point: 14.4V</p> <p>Unit No. DELCO: JFZ193, JFZ198</p>

Brush Holder

Voltage Regulator





Repair Circuit

Rectifier

Diode Trio

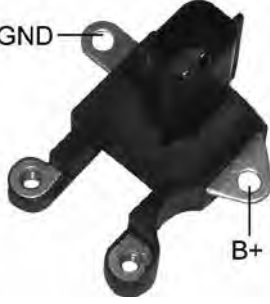
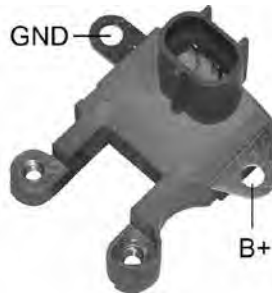
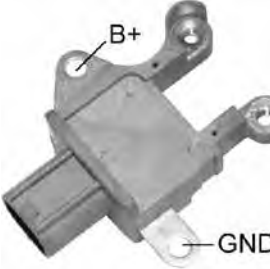
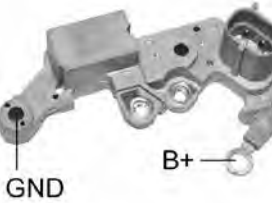
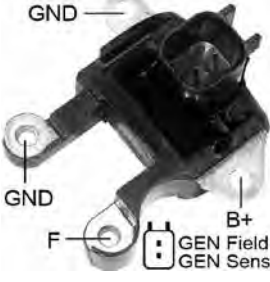
Diode

Tester

 <p>GND</p> <p>B+</p>	<p>TB-ND097 *Terminal Block</p> <p>Replaces DENSO : 126220-0180</p> <p>Unit No. DENSO : 421000-001, 421000-0012,421000-002...</p>	 <p>GND</p> <p>B+</p>	<p>TB-ND098 *Terminal Block</p> <p>Unit No. DENSO : 421000-004, 421000-010,421000-011...</p>
 <p>B+</p> <p>GND</p>	<p>TB-ND099 *Terminal Block</p> <p>Unit No. DENSO : 421000-0060, 421000-0061,421000-0062</p>	 <p>GND</p> <p>B+</p>	<p>TB-ND160 *Terminal Block</p> <p>Replaces DENSO : 126220-0150</p> <p>Unit No. DENSO : 121000-3620, 121000-3630,121000-3670...</p>
 <p>GND</p> <p>GND</p> <p>B+</p> <p>F</p> <p>GEN Field Sense</p>	<p>TB-ND163 *Terminal Block</p> <p>Unit No. CHRYSLER : 56029700AD,4896805AD, 56029914AD DENSO : 421000-0590, 421000-0591,421000-0620...</p>	 <p>GEN Field Sense</p> <p>GEN Sense</p> <p>B+</p> <p>F</p> <p>GND</p>	<p>TB-ND165 *Terminal Block</p> <p>Unit No. CHRYSLER : 4727865AB,480130 4AA,4801311AD,4801480AB DENSO : 421000-038, 421000-041,421000-048...</p>
 <p>B+</p> <p>F1</p> <p>F2</p> <p>GND</p>	<p>TB-ND167 *Terminal Block</p> <p>Replaces DENSO : 126220-0230</p> <p>Unit No. DENSO : 421000-030</p>	 <p>FR L</p> <p>GND</p> <p>B+</p> <p>F(Bottom)</p> <p>P</p>	<p>VR-F161 *Voltage Set Point:14.4V *Soft Start *2.5 sec. LRC *W/Short Circuit Protection</p> <p>Replaces DENSO : 126600-7240</p> <p>Unit No. DENSO : 101210-09710Q,101210- 09610Q... OPEL : 6204283,13256932,6204 258,13222935...</p>
<p>PICTURE IS NOT AVAILABLE</p>	<p>VR-F163</p> <p>Replaces DENSO : 126601-7230</p> <p>Unit No. DENSO : 102211-8622,DAN1033 OPEL : 13256929</p>	<p>PICTURE IS NOT AVAILABLE</p>	<p>VR-F164</p> <p>Replaces DENSO : 126600-7320, 126600-7320</p> <p>Unit No. DENSO : 101210-0910,DAN1061 TOYOTA : 27060-0T010</p>
<p>PICTURE IS NOT AVAILABLE</p>	<p>VR-F169</p> <p>Replaces DENSO : 126601-7220</p> <p>Unit No. DENSO : 101210-0920,101210-0921,4M5T- 10300-LA,4M5T-10300-LB</p>	<p>PICTURE IS NOT AVAILABLE</p>	<p>VR-F171</p> <p>Unit No. CITROEN : 1610048280,9688237 380,9806007480 DENSO : 101210-1720,DAN1071</p>

**VR-H2005-1**

- *A-Circuit
- *Voltage Set Point: 14.4V

Replaces

BOSCH : 0-986-192-017
DENSO : 126000-0030,126000-0060,126000-0100...
TOYOTA : 27700-26050,27700-28030,27700-38100...

Unit No.

DENSO : 021000-0100,021000-0150,021000-0180...
TOYOTA : 27020-28010,27020-28020,27020-45140...

**VR-H2005-10**

- * 63.5mm Mounting Length
- * C-FR-IG-L Terminals
- * L Terminal Drives Choke
- * W/Capacitor Inside
- * Repair Circuit: VR-H2005-10S
- * Voltage Set Point: 14.4V

Replaces

DENSO : 126000-0940,126000-1030,126000-1410...
HONDA : 31150-PM4-003

Unit No.

DENSO : 100211-3590,100211-3660,100211-3690...
HONDA : 31100-P13-0130,31100-P39-0030...

**VR-H2005-100**

- *IG-S-L-FR Terminals
- *Soft Start
- *6.0 sec. LRC
- *Short Circuit Protection
- *W/Capacitor Inside
- *Voltage Set Point: 14.2V
- *Regulation: B-Circuit

Replaces

DENSO : 126600-0520,126600-0540
TOYOTA : 27700-75030,27700-21050

Unit No.

DENSO : 104210-8110,104210-8230,104210-8590
TOYOTA : 27060-75310,27060-75410,27060-75411...

**VR-H2005-101**

- *Soft Start
- *2.5 sec. LRC
- *Voltage Set Point: 13.8V
- *Regulated Voltage Control(RVC)
- *Requires RVC01 tester box for testing

Replaces

DENSO : 126600-3240,126600-3440,126600-4310

Unit No.

DENSO : 104210-3191,104210-3320,104210-4220...

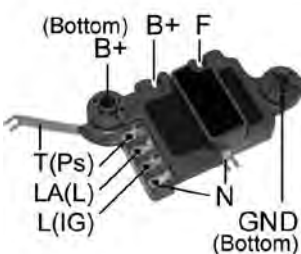
**VR-H2005-102B**

- *24V
- *Voltage Set Point: 28.3V

Unit No.

HINO : 27040-1950,27040-1950A
SAWAFUJI : 0201-152-0114

**VR-H2005-104**

- * L-F Terminals
- * Inactive Lamp
- * Soft Start
- * 2.5 sec. LRC
- * Short Circuit Protection
- * W/Capacitor Inside
- * Voltage Set Point: 14.8V

Replaces

DENSO : 126600-0090

Unit No.

DENSO : 104210-3280

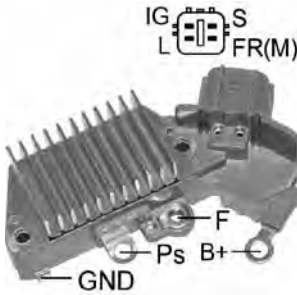
**VR-H2005-105**

- *IG-S-L-FR Terminals
- *Soft Start
- *8.5 sec. LRC
- *Short Circuit Protection
- *W/Capacitor Inside
- *Voltage Set Point:14.4V

Replaces

DENSO : 126000-3720
 TOYOTA : 27700-31040
Unit No.
 TOYOTA : 27060-31010

**VR-H2005-107**

- * L-FR Terminals
- * Inactive Lamp
- * Soft Start
- * 6 sec. LRC
- * Short Circuit Protection
- * Voltage Set Point:13.9V

Replaces

DENSO : GL6A 4430, GL6A3 4500, GL6A3 4520, 126600-4490
 TOYOTA : 449023R08
Unit No.
 DENSO : MA104210-9790, 104210-9680
 TOYOTA : 27060-0M100, 27060-0Y190

**VR-H2005-11**

- * Voltage Set Point:14.4V

Replaces

BOSCH : 0-986-192-019
 DENSO : 126000-0180, 126000-0520, 126000-0770...
 TOYOTA : 27700-57060
Unit No.
 DENSO : 021000-9660, 100211-1720, 100211-1721...
 HINO : 27050-1170A, 27050-1190
 TOYOTA : 27020-64080, 27020-64100, 27040-54010...

**VR-H2005-12**

- *24V
- *S-G-F Terminals
- *Voltage Set Point:27.5V

Replaces

DENSO : 126000-0200
 TOYOTA : 27700-57050
Unit No.
 DENSO : 421000-030

VR-H2005-140

- *Soft Start
- *2.5 sec. LRC
- *Short Circuit Protection
- *Voltage Set Point: 14.4V

Replaces

DENSO : 126000-2650
Unit No.
 DENSO : 101211-7780,
 102211-1180

**VR-H2005-142**

- *Voltage Set Point:14.0V
- *Regulated Voltage Control(RVC)
- *Requires RVC01 tester box for testing

Unit No.

DENSO : 104210-3710, 104210-3711, 104210-3690...

**VR-H2005-144**

- * IG-S-L-FR Terminals
- * 63.5mm Mounting Length
- * L Terminal Does Not Drive Choke
- * S open Lamp off
- * W/Capacitor Inside
- * Voltage Set Point:14.2V

Replaces

DENSO : 126600-0530
Unit No.
 TOYOTA : 27060-0L071

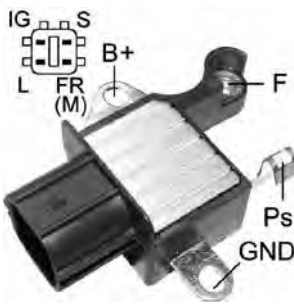

VR-H2005-146
 *IG-S-L-FR Terminals
 *Soft Start
 *W/O LRC
 *Short Circuit Protection
 *Inactive Lamp
 *Voltage Set Point:14.2V

Replaces
 DENSO : 126600-3000,236329,126600-3230
Unit No.
 DENSO : 104210-205,104210-347,104210-420...
 TOYOTA : 27060-0P020,27060-0P030,27060-31020...

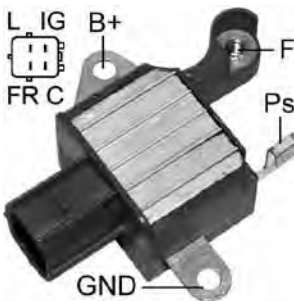

VR-H2005-148
 * Soft Start
 * 8.5 sec. LRC
 * Short Circuit Protection
 * Voltage Set Point:14.4V

Replaces
 DENSO : 126600-3660
Unit No.
 DENSO : 104210-5890
 HONDA : 31100-R40A01

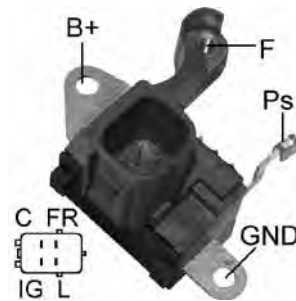

VR-H2005-149
 *Soft Start
 *Short Circuit Protection
 *Voltage Set Point: 14.4V

Replaces
 DENSO : 126600-3650
Unit No.
 DENSO : 104210-5910,
 104210-5920,104210-1240
 HONDA : 31100-R70-A01,
 31100-RGW-A01...



VR-H2005-14H
 * L-IG Terminals
 * 63.5mm Mfg. Length
 * L Terminal Drive Choke
 * W/Capacitor Inside
 * Repair Circuit: VR-H2005-5S
 * Voltage Set Point:14.4V

Replaces
 DENSO : 126000-0371
Unit No.
 DENSO : 100211-1402,100211-1452
 TOYOTA : 27060-87701



VR-H2005-150
 *Voltage Set Point: 14.0V
 *Regulated Voltage Control(RVC)
 *Requires RVC01 tester box for testing

Replaces
 DENSO : 126600-3490
Unit No.
 DENSO : 104210-3601

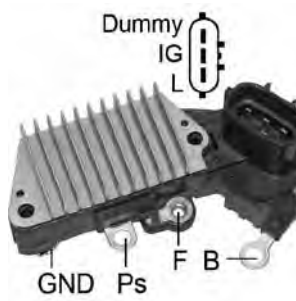

VR-H2005-151B
 * 24V
 * Short Circuit Protection
 * Voltage Set Point: 28.3V

Replaces
 DENSO : 126000-3730
Unit No.
 DENSO : 102211-2820,
 102211-9060



VR-H2005-152
 *Soft Start
 *2.5 sec. LRC
 *Short Circuit Protection
 *Voltage Set Point: 14.4V

Replaces
 DENSO : 126600-3080
Unit No.
 DENSO : 104210-3770
 HONDA : 31100-RDM-A01



VR-H2005-154
 * C-IG-L Terminals
 * 57.5mm Mounting Length
 * Soft Start
 * 8.5 sec. LRC
 * Short Circuit Protection
 * Voltage Set Point: 14.4V

Replaces
 DENSO : 126000-3450

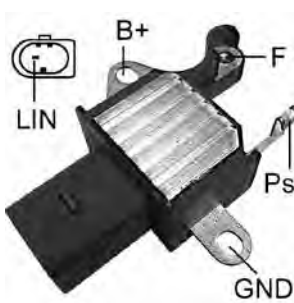

VR-H2005-156
 * Voltage Set Point: 13.7V
 * LIN-1
 * 9600 & 19200 Baud Rate (4 Byte)

Unit No.
 DENSO : 104211-3501,
 104211-3770,104211-4080
 TOYOTA : 27060-0T340,
 27060-0Y350



VR-H2005-159
 *C-IG-L Terminals
 *Soft Start
 *Short Circuit Protection
 *Voltage Set Point:14.4V

Unit No.
 DENSO : 104210-4660
 SUZUKI : 31400-67J00

**VR-H2005-15H**

- * L-IG Terminals
- * 57.5mm Mounting Length
- * L Terminal Drives Choke
- * W/Capactor Inside
- * Repair Circuit: VR-H2005-15S
- * Voltage Set Point:14.4V

Replaces

DENSO : 126000-0970,126000-1160

Unit No.

DENSO : 100211-4003,100211-4020

SUBARU : 23700-KA060

**VR-H2005-162B**

- *24V
- *P-IG-L Terminals
- *63.5mm Mounting Length
- *Voltage Set Point: 28.3V

Replaces

DENSO : 126000-2070

Unit No.

DENSO : 101211-7920

**VR-H2005-163**

- *Voltage Set Point: 13.8V
- *Soft Start
- *2.5 sec. LRC
- *Short Circuit Protection
- *Regulated Voltage Control(RVC)
- *Requires RVC01 tester box for testing

Replaces

DENSO : 126600-3290

Unit No.

DENSO : 104210-4560,104210-5070

GM : 10335498,15826299

**VR-H2005-164A**

- *Soft Start
- *6.0 sec. LRC
- *Short Circuit Protection
- *Voltage Set Point: 14.4V

Replaces

DENSO : 126600-0110

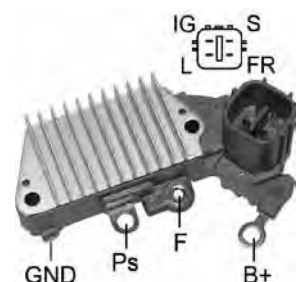
Unit No.DENSO : 104210-3201,104210-3202,104210-4150...
FORD : 3W4T-10300AG,3W4T-10300AH,3W4Z-10346AA...**VR-H2005-165**

- *IG-S-L-FR Terminals
- *Soft Start
- *8.5 sec. LRC
- *Short Circuit Protection
- *Voltage Set Point:13.9V

Replaces

DENSO : 126000-2890

Unit No.

DENSO : 101211-7892

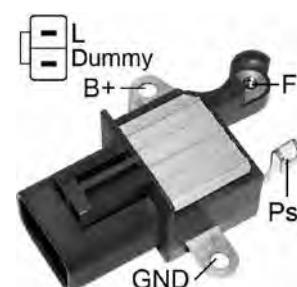
**VR-H2005-166**

- * Soft Start
- * 2.5 sec. LRC
- * Short Circuit Protection
- * Voltage Set Point:14.4V

Replaces

DENSO : 126600-1890

Unit No.DENSO : 104210-9031
TOYOTA : 89736-97161

**VR-H2005-16A**

- * D-IG-L Terminals
- * 63.5mm Mounting Length
- * L Terminal Drives Choke
- * Load Response Control
- * Soft Start
- * W/Capacitor Inside
- * Voltage Set Point: 14.4V

Replaces

DENSO : 126000-1200
ISUZU : 8-97032-091-0

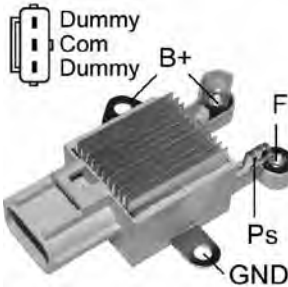
**VR-H2005-171**

- *Voltage Set Point: 13.8V
- *LIN-1 Connections
- *9600 Baud Rate (3 Byte)
- *Requires COM01 test adaptor for testing
- *ID Code: 60

Replaces

DENSO : 126600-7170,126600-7120

Unit No.

DENSO : 104210-4640,DAN1059,104210-3550...
FORD : 3M5T-10300SD,3M5T-10300SC
VOLVO : 30659346,30737529,36001463,8603496...

**VR-H2005-172**

- *Soft Start
- *2.5 sec. LRC
- *Voltage Set Point:14.4V

Replaces

DENSO : 126000-2480

Unit No.

ISUZU : 8971671570,
 8971671571,8971873040...

**VR-H2005-173**

- *Soft Start
- *6.5 sec. LRC
- *Voltage Set Point:14.4V

Replaces

DENSO : 126000-3300

Unit No.

BMW : 12317515030
DENSO : 102211-2230,102211-2231,102211-2232...

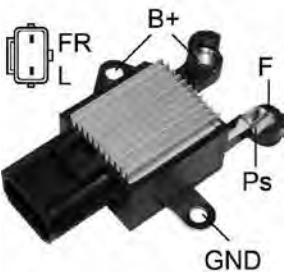
**VR-H2005-176**

- * Soft Start
- * 2.5 sec. LRC
- * Short Circuit Protection
- * Voltage Set Point:14.4V

Unit No.

DENSO : 104210-4050
FORD : 3M5T-10300UA
VOLVO : 30667051A,8602920,86029200

**VR-H2005-177**

- *Voltage Set Point:14.0V
- *Regulated Voltage Control(RVC)
- *Requires RVC01 tester box for testing

Replaces

DENSO : 126600-4210,126600-3600,GC5B 3960,GC5B 5120...

Unit No.

DENSO : 104210-2021,104210-5850,104210-6220...
FORD : 9R3Z-10346D,9L2Z-10346A,9L3T-10300AB

**VR-H2005-178**

- *Voltage Set Point: 14.1V
- *LIN-7 Connections
- *19200 Baud Rate (4 Byte)
- *Requires COM01 test adaptor for testing

Replaces

DENSO : 126000-4060,126600-4360

Unit No.

DENSO : 104211-3000,104211-3290,104211-3313...
TOYOTA : 27060-0N090,27060-36090,27060-0T260

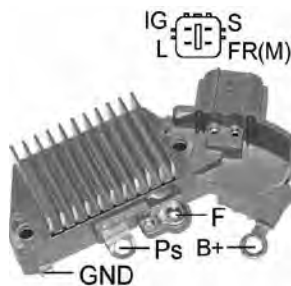
**VR-H2005-179**

- *IG-S-L-FR Terminals
- *Soft Start
- *8.5 sec. LRC
- *Short Circuit Protection
- *Voltage Set Point:14.2V

Replaces

DENSO : 126000-3020,126000-3021
TOYOTA : 27700-27070

Unit No.

DENSO : 102211-0750,MS102211-8500
TOYOTA : 27060-28070,27060-0D170

**VR-H2005-17A**

- *S-IG-L Terminals
- *63.5mm Mounting Length
- *L Terminal Drives Choke
- *Load Response Control
- *Soft Start
- *W/Capacitor Inside
- *Voltage Set Point: 14.4V

Replaces

DENSO : 126000-1400
TOYOTA : 27700-70030

Unit No.

DENSO : 100211-3050,100211-3240,100211-3391...
TOYOTA : 27060-03010,27060-10011,27060-11020...

PICTURE
IS NOT
AVAILABLE

VR-H2005-182**Unit No.**

DENSO : 104210-4640,
104210-3550

**VR-H2005-183**

- *B-Circuit
- *BSS Connections
- *Requires COM01 test adaptor for testing

Replaces

DENSO : 7390

Unit No.

BMW : 12317591529,12317591530,12317591525...
DENSO : 104210-6070,104210-6071,104210-6072

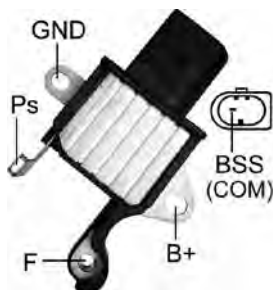
**VR-H2005-184**

- *B-Circuit
- *BSS 3 Connections
- *Requires COM01 test adaptor for testing
- *ID Code: 70

Replaces

DENSO : 7310,7420

Unit No.

BMW : 12317591271,12317591268,12317550468...
DENSO : DAN1040,104210-6021,104210-6254...

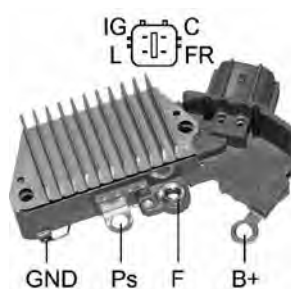
**VR-H2005-185**

- *IG-C-L-FR Terminals
- *Short Circuit Protection
- *Voltage Set Point:14.4V

Replaces

DENSO : 126000-3990

Unit No.

DENSO : 102211-6010
TOYOTA : 27060-B2030

**VR-H2005-186**

- *IG-C-L-FR Terminals
- *Short Circuit Protection
- *Voltage Set Point:14.4V

Unit No.

DENSO : 102211-596

**VR-H2005-187**

- *Soft Start
- *8.0 sec. LRC
- *Short Circuit Protection
- *Voltage Set Point: 14.4V

Replaces

DENSO : 126000-2931

Unit No.

DENSO : 101211-281
HONDA : 31100-PFC-003

VR-H2005-188
 *FR-L-C-IG Terminals
 *Soft Start
 *Short Circuit Protection
 *Voltage Set Point: 14.1V

Unit No.
DENSO : 104210-6191
HYUNDAI : 37300-3F020

VR-H2005-18A
 * S-IG-L Terminals
 * 63.5mm Mounting Length
 * L Terminal Does Not Drive Choke
 * Soft Start
 * Load Response Control
 * W/Capacitor Inside
 * Voltage Set Point:14.4V

Replaces
DENSO : 126000-1260,126000-1270,126000-1190...
TOYOTA : 27700-46030,27700-46040,27700-72090
Unit No.
DENSO : 100211-5360,100211-6180,100211-6300...

VR-H2005-190
 *Voltage Set Point: 14.5V
 *LIN 2
 *19200 Baud Rate (4 Byte)
 *Requires COM01 test adaptor for testing
Replaces
DENSO : 126600-3970
Unit No.
DENSO : 104210-1530,104210-1490,104211-3470

VR-H2005-193
 *Soft Start
 *Short Circuit Protection
 *Voltage Set Point:14.4V
Unit No.
DENSO : 104210-1060, 104210-2870
HYUNDAI : 37300-2F200

VR-H2005-194
 * Voltage Set Point: 13.7V
 * LIN-1
 * 9600 Baud Rate (4 Byte)
 * Requires COM01 test adaptor for testing
 *ID Code: 28

Replaces
DENSO : 3570
Unit No.
DENSO : 104210-1470,104210-2420,104210-6120...

VR-H2005-195
Unit No.
HYUNDAI : 37300-4A310

PICTURE IS NOT AVAILABLE

VR-H2005-196
Replaces
DENSO : 126000-2100
Unit No.
DENSO : 101211-9230
HONDA : 31100-P2C-0030

PICTURE IS NOT AVAILABLE

VR-H2005-197
 *IG-C-L-FR Terminals
 *Soft Start
 *2.5 sec. LRC
 *Short Circuit Protection
 *Voltage Set Point:14.1V

Replaces
DENSO : 126000-3370
TOYOTA : 27700-21040
Unit No.
DENSO : 102211-0920
TOYOTA : 27060-28160

Brush Holder

Voltage Regulator

Repair Circuit

Rectifier

Diode Trio

Diode

Tester

VR-H2005-198

PICTURE IS NOT AVAILABLE

Unit No.
 DENSO : DAN1093,104211-3090,DAN1094,104211-3130
 TOYOTA : 27060-0Y130,27060-0Y160,27060-0N100

VR-H2005-199

PICTURE IS NOT AVAILABLE

Replaces
 DENSO : 104210-8070
Unit No.
 TOYOTA : 27060-28220



VR-H2005-19A
 * D-FR-IG-L Terminals
 * 63.5mm Mounting Length
 * L Terminal Drives Choke
 * Load Response Control
 * Soft Start
 * W/Capacitor Inside
 * Voltage Set Point:14.4V

Replaces
 DENSO : 126000-1470
Unit No.
 DENSO : 100211-8910,100211-9100
 HONDA : 31100-PR4-C01



VR-H2005-2
 * W/Capacitor Inside
 * Voltage Set Point:14.4V

Replaces
 DENSO : 126000-0920,126000-1460
 TOYOTA : 27000-64040,27700-64110
Unit No.
 DENSO : 100213-0750,100213-0760,100213-0950...
 TOYOTA : 27040-64070,27040-64080,27040-64110...



VR-H2005-200
 * FR-IG-L Terminals
 * 63.5mm Mounting Length
 * Soft Start
 * 6.5 sec. LRC
 * Short Circuit Protection
 * Voltage Set Point:14.6V

Replaces
 DENSO : 126000-3290
Unit No.
 DENSO : 101211-9570,102211-1780,102211-2220...



VR-H2005-203
 * Voltage Set Point: 13.8V
 * LIN-5 Connections
 * 19200 Baud Rate (4 Byte)
 * Requires COM01 test adaptor for testing

Unit No.
 DENSO : 104210-1890,104211-8270,104211-8300...
 HONDA : 31100-5G0-A02,31100-5G0-A02RM...

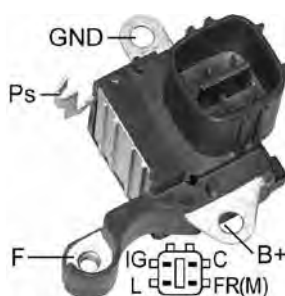

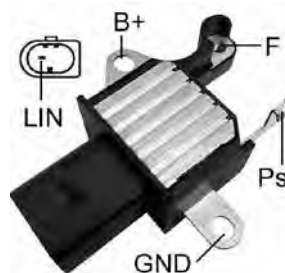

VR-H2005-204
 * Soft Start
 * 10 sec. LRC
 * Short Circuit Protection
 * Voltage Set Point:14.4V

Unit No.
 DENSO : 104210-2450



VR-H2005-206
 * Voltage Set Point: 14.3V
 * LIN-1
 * 9600&19200 Baud Rate (4 Byte)

Replaces
 DENSO : 7730,7511
Unit No.
 DENSO : 104210-6401, 104210-6402

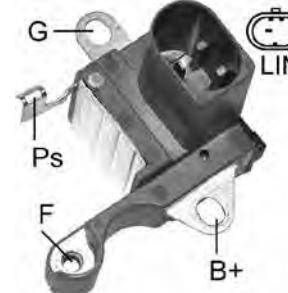
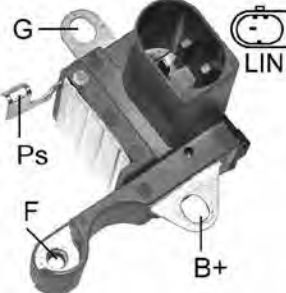
<p style="text-align: center;">PICTURE IS NOT AVAILABLE</p>	<p>VR-H2005-208</p> <ul style="list-style-type: none"> * Soft Start * 10 sec. LRC * Short Circuit Protection * Voltage Set Point:14.4V <p>Replaces DENSO : 126000-3080, 126000-3081 Unit No. TOYOTA : 27060-27030</p>
 <p>VR-H2005-213</p> <ul style="list-style-type: none"> *Voltage Set Point: 14V *Regulated Voltage Control(RVC) *Requires RVC01 tester box for testing <p>Unit No. DENSO : 126600-3960, 104210-6182 FORD : 9C2T-10300CA</p>	 <p>VR-H2005-210</p> <ul style="list-style-type: none"> * Voltage Set Point: 14.3V * LIN * 9600 & 19200 Baud Rate (4 Byte) * ID Code: 50 <p>Replaces DENSO : 7541 Unit No. BMW : 12317616119,7616119, 12317616121,7616121 DENSO : 104210-6500, 104210-6501,104210-6502...</p>
 <p>VR-H2005-214</p> <ul style="list-style-type: none"> *Voltage Set Point: 13.7V *LIN-1 Connections *9600&19200 Baud Rate (4 Byte) <p>Replaces DENSO : IFX 8150 Unit No. DENSO : 104211-0510 TOYOTA : 27060-0V180</p>	 <p>VR-H2005-215</p> <ul style="list-style-type: none"> * Voltage Set Point: 14.3V * LIN * 9600 & 19200 Baud Rate (4 Byte) * ID Code: 34 <p>Replaces DENSO : IFX1 7740 Unit No. DENSO : 104210-6721</p>
 <p>VR-H2005-218</p> <ul style="list-style-type: none"> *Voltage Set Point: 14.3V *LIN *9600&19200 Baud Rate (4 Byte) *ID Code: 122 <p>Replaces DENSO : IFX1 7841 Unit No. AUDI : 06E903024G,059903024E DENSO : 104210-0152, 104210-6681</p>	 <p>VR-H2005-219</p> <ul style="list-style-type: none"> *Voltage Set Point: 14.3V *LIN *9600&19200 Baud Rate (4 Byte) *ID Code: 26 <p>Replaces DENSO : IFX1 7510 Unit No. BMW : 12317605060,12317610260 DENSO : 104210-6330,104210-6331,104210-6332...</p>
<p style="text-align: center;">PICTURE IS NOT AVAILABLE</p>	 <p>VR-H2005-221</p> <p>Unit No. CITROEN : 9678178280 DENSO : 104211-8210, 104211-8211</p>
 <p>VR-H2005-222</p> <p>Unit No. DENSO : 104211-3761 TOYOTA : 27060-0P350</p>	<p style="text-align: center;">PICTURE IS NOT AVAILABLE</p> <p>VR-H2005-223</p> <p>Unit No. DENSO : 104211-3750 TOYOTA : 27060-31340</p> <p>VR-H2005-226</p> <ul style="list-style-type: none"> *LIN <p>Unit No. DENSO : 104211-8380 VOLKSWAGEN : 03L 903 024, 03L 903 024X</p>

- Brush Holder
- Voltage Regulator
- Repair Circuit
- Rectifier
- Diode Trio
- Diode
- Tester

**VR-H2005-23A**

- * S-IG-L Terminals
- * 57.5mm Mounting Length
- * L Terminal Drives Choke
- * Soft Start
- * Load Response Control
- * W/Capacitor Inside
- * Repair Circuit: VR-H2005-23AS
- * Voltage Set Point:14.4V

Replaces

DENSO : 126000-0550,126000-0980,126000-0900...
 LUCAS : UCJ423
 MAGNETI MARELLI : 940038087
 TOYOTA : 27700-10050,27700-10080

Unit No.

DENSO : 100211-1520,100211-1560,100211-1620...
 TOYOTA : 27060-10070,27060-10071,27060-10100...

**VR-H2005-24**

- * D-IG-L Terminals
- * 57.5mm Mounting Length
- * L Terminal Drives Choke
- * W/Capacitor Inside
- * Repair Circuit: VR-H2005-15S
- * Voltage Set Point:14.4V

Replaces

DENSO : 126000-0850,126000-0880
 ISUZU : 8-94455-160

Unit No.

DENSO : 100211-4130,100211-4260,100211-6600...
 ISUZU : 8-94449-781-0
 SUZUKI : 31400-60B40

**VR-H2005-25**

- * C-IG-L Terminals
- * 57.5mm Mounting Length
- * L Terminal Drives Choke
- * W/Capacitor Inside
- * Repair Circuit: VR-H2005-25S
- * Voltage Set Point:14.4V

Replaces

DENSO : 126000-0840

Unit No.

DENSO : 100211-4150,100211-4110
 GM : 96056770
 SUZUKI : 31400-86210

**VR-H2005-26A**

- * D-IG-L Terminals
- * 57.5mm Mounting Length
- * L Terminal Does Not Drive Choke
- * W/Capacitor Inside
- * Repair Circuit: VR-H2005-26AS
- * Voltage Set Point:14.4V

Replaces

DENSO : 126000-0721,126000-0950,126000-1330...
 ISUZU : 8-94455160-0
 SUZUKI : 32500-86511

Unit No.

DENSO : 100211-1550,100211-1570,100211-6720
 SUZUKI : 31400-60840,31400-86010,31400-86510

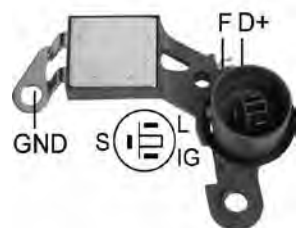
**VR-H2005-28**

- * S-IG-L Terminals
- * Repair Circuit: VR-H2005-3S
- * Voltage Set Point:14.4V

Replaces

DENSO : 126000-0360,126000-0460,126000-0500...

Unit No.

DENSO : 100211-0680,100211-0730,100211-0760...
 HINO : 27040-1240A,27040-1261A
 TOYOTA : 27060-16030,27060-61090,27060-63010...

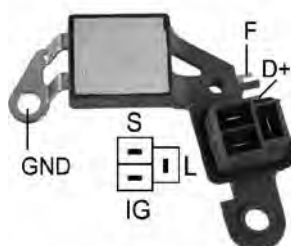
**VR-H2005-29**

- * L-S-IG Terminals
- * Repair Circuit: VR-H2005-3S
- * Voltage Set Point:14.4V

Replaces

DENSO : 126000-0270
 ISUZU : 8-94239-079-0

Unit No.

DENSO : 100211-0581,100211-0990
 KUBOTA : 15451-99371

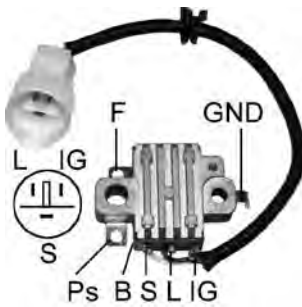
**VR-H2005-2W**

- * W/Capacitor Inside
- * Voltage Set Point:14.4V

Replaces

DENSO : 126000-0920,126000-1460
TOYOTA : 27000-64040

Unit No.

DENSO : 100213-0750,100213-0760,100213-0950...
TOYOTA : 27040-64070,27040-64080,27040-64110...

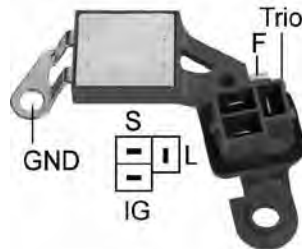
**VR-H2005-3**

- * S-IG-L Terminals
- * Repair Circuit:VR-H2005-3S
- * Voltage Set Point:14.4V

Replaces

BOSCH : 0-986-192-023
DENSO : 126000-0170,126000-0450,126000-0490...
TOYOTA : 27700-43010,27700-44040

Unit No.

DENSO : 100211-0270,100211-0500,100211-0530...
TOYOTA : 27020-16010,27020-16030,27020-16040...

**VR-H2005-30A**

- * S-IG-L Terminals
- * 63.5mm Mounting Length
- * L Terminal Drive Choke
- * Load Response Control
- * Soft Start
- * W/Capacitor Inside
- * Voltage Set Point:14.4V

Replaces

DENSO : 126000-1730,126000-1750,126000-1930...
TOYOTA : 27700-11070,27700-66040,27700-50020...

Unit No.

DENSO : 101211-0100,101211-0190,101211-0340...
TOYOTA : 27060-02050,27060-02070,27060-11270...

**VR-H2005-31A**

- * S-IG-L Terminals
- * 63.5mm Mounting Length
- * L Terminal Does Not Drive Choke
- * Soft Start
- * Load Response Control
- * W/Capacitor Inside
- * Voltage Set Point:14.4V

Replaces

DENSO : 126000-1580,126000-1640,126000-1660...
TOYOTA : 27700-35040,27700-74030,27700-40050...

Unit No.

DENSO : 100211-0050,100211-5020,100211-5110...
TOYOTA : 27060-11281,27060-15080,27060-15090...

**VR-H2005-32A**

- * S-IG-L Terminals
- * 57.5mm Mounting Length
- * L Terminal Drives Choke
- * Load Response Control
- * Soft Start
- * W/Capacitor Inside
- * Voltage Set Point:14.4V

Replaces

DENSO : 126000-1630,126000-959
TOYOTA : 27700-11060

Unit No.

DENSO : 100211-2130
TOYOTA : 27060-11250

**VR-H2005-33A**

- * S-IG-L Terminals
- * 63.5mm Mounting Length
- * L Terminal Does Not Drive Choke
- * Soft Start
- * W/Capacitor Inside
- * Repair Circuit: VR-H2005-33AS
- * Voltage Set Point:14.4V

Replaces

DENSO : 126000-0610,126000-1110
TOYOTA : 27700-74010

Unit No.

DENSO : 100211-5210,100211-6110,100211-7470...
TOYOTA : 27060-46010,27060-46020,27060-62050...

**VR-H2005-34**

- * L Terminal
- * 63.5mm Mounting Length
- * L Terminal Drives Choke.
- * W/Capacitor Inside
- * Voltage Set Point:14.4V

Replaces

DENSO : 126000-1130,126000-1760,126000-7160

Unit No.

DENSO : 100211-8370,100211-8620,100211-8630

**VR-H2005-35**

- * S-IG-L Terminals
- * 63.5mm Mounting Length
- * L Terminal Does Not Drive Choke
- * W/Capacitor Inside
- * Voltage Set Point:14.0V

Replaces

DENSO : 126000-7100

Unit No.

DENSO : 101211-0130,101211-0300,101211-7010

**VR-H2005-36A**

- * S-IG-L Terminals
- * 63.5mm Mounting Length
- * L Terminal Drives Choke
- * Load Response Control
- * Soft Start
- * W/Capacitor Inside
- * Voltage Set Point:14.4V

Unit No.

DENSO : 100211-5620

**VR-H2005-37A**

- * L Terminal Drives Choke
- * Soft Start
- * 8.5 sec. LRC
- * W/Capacitor Inside
- * Voltage Set Point:14.4V

Replaces

BOSCH : 0-986-192-024

DENSO : 126000-0300,126000-0301,126000-0302...

HONDA : 31400-SA5-004,31400-SA5-671,31400-SA5-A0300...

Unit No.

DENSO : 021000-977,021000-983

HONDA : 31100-PC1-004,31100-PC1-020...

**VR-H2005-39**

- * L-IG Terminals
- * 57.5mm Mounting Length
- * L Terminal Does Not Drive Choke
- * W/Capacitor Inside
- * Repair Circuit: VR-H2005-26AS
- * Voltage Set Point:14.4V

Replaces

DAIHATSU : 27700-87207,27700-96301

DENSO : 126000-0600

ISEKI : 281-271-001-0

TOYOTA : 27700-78301

Unit No.

DENSO : 100211-1550,100211-1670,100211-1680

ISHIKAWAJIMA : 18504-6220

mitsubishi Motors : MD604589

**VR-H2005-39SE**

- * 57.5mm Mounting Length
- * Self Exciting
- * W/Capacitor Inside
- * Voltage Set Point:14.6V

Replaces

DENSO : 126000-0600,126000-0760,126000-1160

Unit No.

DENSO : 100211-1511,100211-1540,100211-1550...

**VR-H2005-40**

- * IG-C-L-FR Terminals
- * 63.5mm Mounting Length
- * Soft Start
- * 2.5 Sec. LRC
- * Short Circuit Protection
- * L Terminal Does Not Drive Choke
- * W/0.47 μ F Capacitor Inside
- * Repair Circuit: VR-H2005-22S
- * Voltage Set Point: 14.4V

Replaces

DENSO : 126000-2090,126000-2160,126000-2170...
HONDA : 31150-P2T-0030
MAGNETI MARELLI : 940038097

Unit No.

DENSO : 101211-9380,101211-9390,101211-9820...

**VR-H2005-40A**

- * IG-C-L-FR Terminals
- * 63.5mm Mounting Length
- * Soft Start
- * 2.5 sec. LRC
- * Short Circuit Protection
- * L Terminal Does Not Drive Choke
- * W/ 2.7 μ F Capacitor Outside
- * Voltage Set Point: 15.1V

Replaces

DENSO : 126000-3430

Unit No.

DENSO : 102211-086,102211-087
JAGUAR : XR822418

**VR-H2005-40T**

- * Same as VR-H2005-40 w/ choke function

**VR-H2005-45A**

- * S-IG-L Terminals
- * 63.5mm Mounting Length
- * L Terminal Drive Choke
- * Soft Start
- * Load Response Control
- * W/Capacitor Inside
- * Repair Circuit: VR-H2005-4AS
- * Voltage Set Point: 14.4V

Replaces

DENSO : 126000-1520, 126000-1521

**VR-H2005-46A**

- * S-IG-L Terminals
- * 63.5mm Mounting Length
- * L Terminal Does Not Drive Choke
- * Soft Start
- * W/Capacitor Inside
- * Repair Circuit: VR-H2005-33AS
- * Voltage Set Point: 14.4V

Replaces

DENSO : 126000-1670,126000-2050,126000-2200...

Unit No.

DENSO : 101211-0300,101211-7300,101211-7301...

**VR-H2005-48A**

- * D-IG-L Terminals
- * 63.5mm Mounting Length
- * L Terminal Does Not Drive Choke
- * Soft Start
- * Load Response Control
- * W/Capacitor Inside
- * Voltage Set Point: 14.4V

Replaces

DENSO : 126000-1920,126000-1970,126000-1971...

Unit No.

DENSO : 101211-0550,101211-0720,102211-5070
SUZUKI : 31400-60G11,31400-60G12

**VR-H2005-4A**

- * S-IG-L Terminals
- * 63.5mm Mounting Length
- * L Terminal Drives Choke
- * Soft Start
- * W/Capacitor Inside
- * Repair Circuit: VR-H2005-4AS
- * Voltage Set Point: 14.4V

Replaces

BOSCH : 0-986-192-021
DENSO : 126000-0340,126000-0510,126000-0650...
GM : 94139012,94840314
HONDA : 31150-PD1-004,31150-PD2-004,31150-PDJ-004
ISUZU : 8-9413-053-0
LUCAS : UCB412
TOYOTA : 27700-01010,27700-63021,27700-72070...

Unit No.

DENSO : 100211-1000,100211-1001,100211-1011...
HONDA : 31100-PD1-014,31100-PD1-024...
ISUZU : 8-94109-911-5,8-94120-564-4...
TOYOTA : 27040-64040,27040-64050,27060-10010...

**VR-H2005-50A**

- * S-IG-L Terminals
- * 57.5mm Mounting Length
- * L Terminal Drives Choke
- * Load Response Control
- * Soft Start
- * W/Capacitor Inside
- * Voltage Set Point:14.4V

Replaces

DENSO : 126000-1740

**VR-H2005-52A**

- * S-IG-L Terminals
- * 57.5mm Mounting Length
- * L Terminal Does Not Drive Choke
- * Load Response Control
- * Soft Start
- * W/Capacitor Inside
- * Voltage Set Point:14.4V

Replaces

DENSO : 126000-2400

Unit No.

DENSO : 101211-373,101211-858

**VR-H2005-58**

- * 24V
- * S-IG-L Terminals
- * L Terminal Does Not Drive Choke
- * W/Capacitor Inside
- * 63.5mm Mounting Length
- * Voltage Set Point:28.3V

Replaces

DENSO : 126000-7010,126000-7011,126000-2340

TOYOTA : 27700-58020

Unit No.

DENSO : 100211-6200,100211-6210,100211-6221

**VR-H2005-59**

- * P-IG-L Terminals
- * W/Capacitor Inside
- * 63.5mm Mounting Length
- * Voltage Set Point:14.4V

Replaces

DENSO : 126000-1940,126000-2181,101211-0690...

KUBOTA : 19260-64011,19260-64012,19279-64010...

PRESTOLITE : 20130227,20130227

YANMAR : 119773-77200

Unit No.

DENSO : 101211-9020,101211-0690,101211-4280...

**VR-H2005-5H**

- * D-IG-L Terminals
- * 63.5mm Mounting Length
- * L Terminal Drives Choke
- * W/Capacitor Inside
- * Repair Circuit:VR-H2005-5S
- * Voltage Set Point:14.4V

Replaces

DENSO : 126000-0430

ISUZU : 8-94139-012-0

Unit No.

DENSO : 100211-1270,100211-1271,100211-1331...

ISUZU : 8-94137-345-2

**VR-H2005-60**

- * P-IG-L Terminals
- * L Active
- * Soft Start
- * 2.5 sec. LRC
- * W/Capacitor Inside
- * 57.5mm Mounting Length
- * Voltage Set Point:14.4V

Replaces

DENSO : 126000-1800

Unit No.

DENSO : 101211-2310

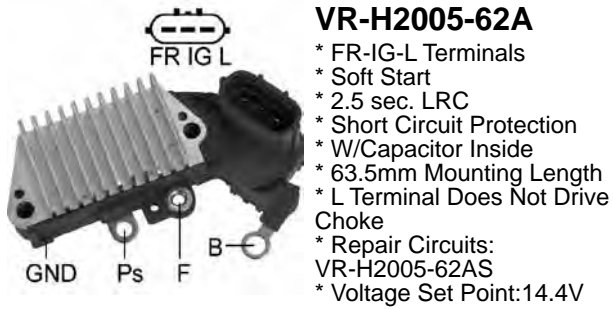
**VR-H2005-62A**

- * FR-IG-L Terminals
- * Soft Start
- * 2.5 sec. LRC
- * Short Circuit Protection
- * W/Capacitor Inside
- * 63.5mm Mounting Length
- * L Terminal Does Not Drive Choke
- * Repair Circuits:
VR-H2005-62AS
- * Voltage Set Point:14.4V

Replaces

DENSO : 126000-3040,126000-2861

Unit No.

DENSO : 102211-1860,102211-9820,102211-9880...
 HONDA : 31100-P2E-G01,31100-P7F-00331
 TOYOTA : 27060-23010,27060-23070

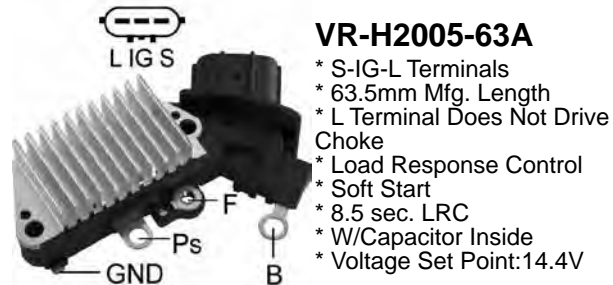
**VR-H2005-63A**

- * S-IG-L Terminals
- * 63.5mm Mfg. Length
- * L Terminal Does Not Drive Choke
- * Load Response Control
- * Soft Start
- * 8.5 sec. LRC
- * W/Capacitor Inside
- * Voltage Set Point:14.4V

Replaces

DENSO : 126000-1870,126000-2260

TOYOTA : 27700-20050,27700-46060,27700-62010...

**VR-H2005-64A**

- * IG-S-L-FR Terminals
- * 63.5mm Mfg.Length
- * L Terminal Does Not Drive Choke
- * Load Response Control
- * Soft Start
- * W/Capacitor Inside
- * Repair Circuit:
VR-H2005-64AS
- * Voltage Set Point:14.4V

Replaces

DENSO : 126000-2190,126000-3690

TOYOTA : 27700-50040

Unit No.

DENSO : 101211-7230,101211-7270,104210-800...
 HONDA : 31100-P5A-003
 TOYOTA : 27060-50300,27060-62240,27060-0L020...

**VR-H2005-65**

- * M-IG-L Terminals
- * 63.5mm Mounting Length
- * L Terminal Does Not Drive Choke
- * Load Response Control
- * Soft Start
- * W/Capacitor Inside
- * Voltage Setting:14.4V

Replaces

DENSO : 126000-3170,126000-3171

TOYOTA : 27700-21020

Unit No.

DENSO : 100211-5380,100211-5480

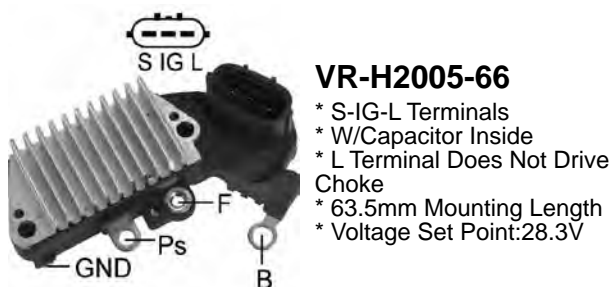
**VR-H2005-66**

- * S-IG-L Terminals
- * W/Capacitor Inside
- * L Terminal Does Not Drive Choke
- * 63.5mm Mounting Length
- * Voltage Set Point:28.3V

Replaces

DENSO : 126000-7120

TOYOTA : 27700-58040

Unit No.

DENSO : 100211-6240,100211-6250,100211-6260
 TOYOTA : 27060-17120,27060-58150,27060-58230...

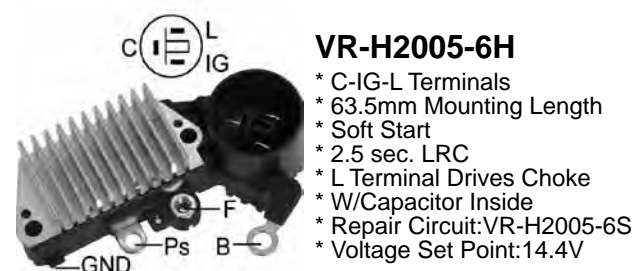
**VR-H2005-6H**

- * C-IG-L Terminals
- * 63.5mm Mounting Length
- * Soft Start
- * 2.5 sec. LRC
- * L Terminal Drives Choke
- * W/Capacitor Inside
- * Repair Circuit:VR-H2005-6S
- * Voltage Set Point:14.4V

Replaces

DENSO : 126000-0440

HONDA : 31150-PE0-921

Unit No.

DENSO : 100211-1260
 HONDA : 31100-PE0-924

**VR-H2005-77**

- * C-IG-L Terminals
- * 63.5mm Mounting Length
- * L Terminal Drives Choke
- * W/Capacitor Inside
- * Voltage Set Point: 14.4V

Replaces

DENSO : 126000-2150,126000-2151
ISUZU : 8-97122796-0

Unit No.

DENSO : 101211-4220
ISUZU : 29012-37800,29012-37801,89710-97800...

**VR-H2005-7A**

- * D-IG-L Terminals
- * 63.5mm Mounting Length
- * L Terminal Does Not Drive Choke
- * W/Capacitor Inside
- * Voltage Set Point:14.4V

Replaces

BOSCH : 0-986-192-022
DENSO : 126000-0410,126000-0411,126000-0470
GM : 96052000
HONDA : 31150-PE0-003
MAGNETI MARELLI : 943241001,MSR1001
SUZUKI : 32500-82610

Unit No.

DENSO : 100211-1400,100211-1411
SUZUKI : 9605-1973,9605-4116

**VR-H2005-8**

- * D-FR-IG-L Terminals
- * 63.5mm Mounting Length
- * L Terminal Drives Choke
- * W/Capacitor Inside
- * Voltage Set Point:14.4V

Replaces

DENSO : 126000-0570
HONDA : 31150-PE7-661,31150-PE7-6620

Unit No.

DENSO : 100211-1351,100211-1370,100211-7330
HONDA : 31100-P3003,31100-PE7-660,31100-PE7-661...

**VR-H2005-81**

- * M-IG-L Terminals
- * 63.5mm Mounting Length
- * L Terminal Does Not Drive Choke
- * Soft Start
- * Load Response Control
- * W/Capacitor Inside
- * Voltage Set Point:14.2V

Unit No.

DENSO : 102211-167,102211-168
TOYOTA : 27060-23020,27060-23030

**VR-H2005-82**

- * M-IG-L Terminals
- * 63.5mm Mounting Length
- * Load Response Control
- * Soft Start
- * W/Capacitor Inside
- * Voltage Set Point:14.4V

Replaces

DENSO : 126000-2871

Unit No.

DENSO : 102211-1471

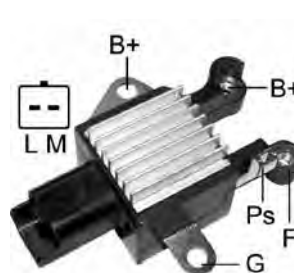
**VR-H2005-83**

- * M-L Terminals
- * Soft Start
- * 2.5 sec. LRC
- * Short Circuit Protected
- * W/Capacitor Inside
- * Voltage Set Point: 14.4V

Replaces

DENSO : N810F01288,ST17001

Unit No.

DENSO : 104210-3170,
104210-3240

**VR-H2005-85**

- * IG-S-L-FR Terminals
- * Soft Start
- * 6.0 sec. LRC
- * Short Circuit Protection
- * Inactive Lamp
- * W/Capacitor Inside
- * Voltage Set Point:14.2V

Replaces

DENSO : 126600-3010,126600-3040,126600-3390...
TOYOTA : 27700-20090,27700-20100,27060-0C021...

Unit No.

DENSO : 104210-345,104210-362,104210-365...
TOYOTA : 27060-0A110,27060-0A120,27060-0A130...

**VR-H2005-87**

- * D-IG-L Terminals
- * Soft Start
- * 2.5 sec. LRC
- * 57.5mm Mounting Length
- * Voltage Set Point:14.4V

Replaces

DENSO : 126000-2490

Unit No.

TOYOTA : 27060-87726

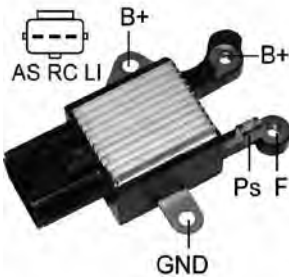
**VR-H2005-88**

- * A-Circuit
- * AS-RC-LI Terminals
- * Short Circuit Protection
- * Voltage Set Point:14.2V
- * Regulated Voltage Control(RVC)
- * Requires RVC01 tester box for testing

Replaces

DENSO : PCM-01,126600-3460

Unit No.

DENSO : 104210-3512,104210-4091 ,104210-4700...

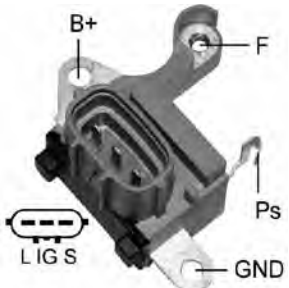
**VR-H2005-89**

- * S-IG-L Terminals
- * Soft Start
- * Short Circuit Protection
- * W/Capacitor Inside
- * Voltage Set Point:14.2V

Replaces

DENSO : 126600-0011

Unit No.

DENSO : 104210-3030,104210-3031,104210-3920...

**VR-H2005-90**

- * IG-C-L-FR(M) Terminals
- * B-Circuit
- * Soft Start
- * 8.5 sec. LRC
- * Short Circuit Protection
- * W/Capacitor Inside
- * Voltage Set Point:14.4V

Replaces

DENSO : 122600-0140,126600-3200,126600-3350...

HONDA : 31150-RAA-A030M,31150-RAA-A010M

Unit No.

DENSO : 104210-3290,104210-3291,104210-3292...

HONDA : 31100-RAA-A01,31100-RAA-A03...

TOYOTA : 27060-51010,27060-51020

**VR-H2005-91**

- * IG-S-L-FR(M) Terminals
- * B-Circuit
- * Inactive Lamp
- * Soft Start
- * Short Circuit Protection
- * W/Capacitor Inside
- * Voltage Set Point:14.2V

Replaces

DENSO : 126600-0150

Unit No.

DENSO : 104210-3380,104210-3381,104210-3390...

TOYOTA : 27060-30080

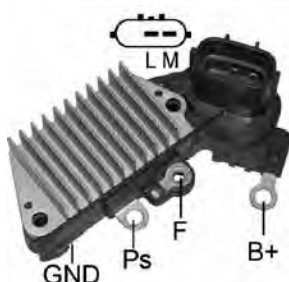
**VR-H2005-92**

- * L-M Terminals
- * Soft Start
- * 2.5 sec LRC
- * Short Circuit Protection
- * W/Capacitor Inside
- * Voltage Set Point:14.4V

Unit No.

HYUNDAI : 37300-3C120,37300-3C170

POONG SUNG : 02131-9153,02131-9330

**VR-H2005-93**

- * S-IG-L Terminals
- * B-Circuit
- * Inactive Lamp
- * Soft Start
- * 6.0 sec. LRC
- * Short Circuit Protection
- * W/Capacitor Inside
- * Voltage Set Point:14.2V

Replaces

DENSO : 126600-0022,126600-0023

Unit No.DENSO : 102410-304,104210-312
TOYOTA : 27060-20170,27060-20190**VR-H2005-94**

- * S-F-L Terminals
- * B-Circuit
- * Soft Start
- * 8.5 sec. LRC
- * W/Capacitor Inside
- * Short Circuit Protection
- * Voltage Set Point:14.6V

Replaces

DENSO : 126600-0030,126600-0031

Unit No.DENSO : 10421-0306,10421-0307,10421-0330
GM : 25697765,25697766,25759348,25759776**VR-H2005-95**

- * RLO-IG-L-M Terminals
- * W/Capacitor Inside
- * Voltage Set Point: 14.2V
- * Regulated Voltage Control(RVC)
- * Requires RVC01 tester box & VR-RVC01W test adaptor for testing

Replaces

DENSO : 126600-3020,126600-3220,126600-3320...

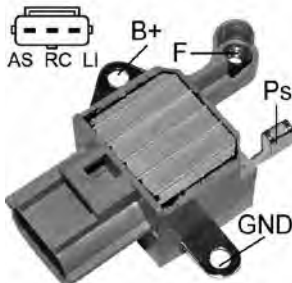
Unit No.DENSO : 104210-479,104210-209,104210-474...
TOYOTA : 27060-28300,27060-31090,27060-31100...**VR-H2005-96**

- * B-Circuit
- * AS-RC-LI Terminals
- * W/Capacitor Inside
- * Regulated Voltage Control(RVC)
- * Used on 2nd Generation Ford Focus C-Max
- * Requires RVC01 tester box for testing

Replaces

DENSO : 126600-3430,126600-3640,GC5B 3950,GC5B 4200...

Unit No.DENSO : 104210-3513,104210-3523,104210-6101...
FORD : 3M5T-10300PB,3M5T-10300PD,7C3T-10300EE...**VR-H2005-99**

- * Inactive Lamp
- * IG-C-L-M(FR) Terminals
- * Soft Start
- * 2.5 sec. LRC
- * Short Circuit Protection
- * W/Capacitor Inside
- * Voltage Set Point:14.4V

Replaces

DENSO : 126600-0041,126600-0042,126600-0040...

Unit No.

DENSO : 104210-309,104210-3091,104210-3092...

**VR-H2005-9A**

- * S-FR-IG-L Terminals
- * 63.5mm Mounting Length
- * L Terminal Drives Choke
- * Soft Start
- * W/Capacitor Inside
- * Repair Circuit: VR-H2005-9AS
- * Voltage Set Point:14.4V

ReplacesDENSO : 126000-0540,126000-1170
HONDA : 31150-PD6-004,31150-PD6-014,31150-PD6-024...**Unit No.**DENSO : 100211-2010,100211-2130,100211-2140...
HONDA : 31000-PH7-013,31100-PD6-014...



VR-F540A

- *Regitar No.:GR540A
- *Short Circuit Protected
- *For use on Ford car & Trucks
- *Voltage Set Point:14.5V

Replaces

FORD : D9PZ-10316A,E2PZ-10316A,E4AZ-10316B
 MOTORCRAFT : GR504,GR533,GR534,GR540,GR540A



VR-F540DH

- *Regitar No.:GR540DH
- *Compatible With 7 Amp Rotors
- *Digital Dash Compatible
- *Short Circuit Protected
- *For use on Ford, Mercurys & Lincolns
- *Voltage Set Point:14.5V

Replaces

FORD : E6DF-10316AA

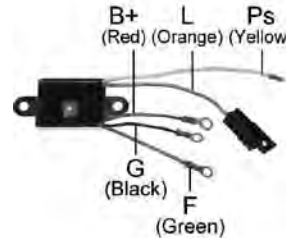

VR-F7078

- *Nominal Adjustable
- *PS Open Lamp On
- *Voltage Set Point:14.2V
- *For Ford 1G Series 45-65A ER/EF Alternators

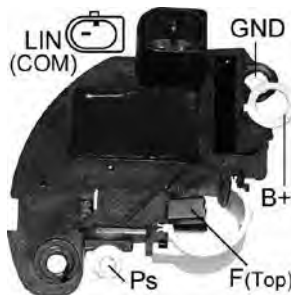

VR-F756

- *B-Circuit
- *Voltage Set Point: 13.7V
- *LIN-11
- *19200 Baud Rate (4 Byte)
- *Requires COM01 test adaptor for testing
- *ID Code: 76

Unit No.

DENSO : MS101210-1700, 51880173

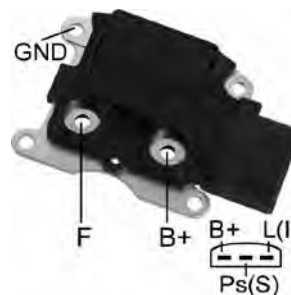

VR-F784H

- *Regitar No.:GR784
- *For Use on: Ford 2G, 3G Alternators
- *Voltage Set Point:14.45V

Replaces

FORD : E43F-10316AA, E43Z-10316A,E43Z-10316B...
 VALEO : VR-231

Unit No.

FORD : D53F-10300AA,D53F-10300BA,D53F-10300DA...

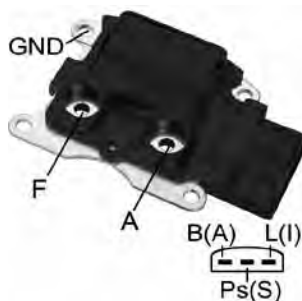

VR-F784M

- *Regitar No.:GR784M
- *Short Circuit Protected
- *For Use on: Ford 2G, 3G Alternators
- *Voltage Set Point: 14.7V

Replaces

FORD : E43F-10316AA,E43Z-10316A,E43Z-10316B...

Unit No.

FORD : D53F-10300AA,D53F-10300BA,D53F-10300EA...

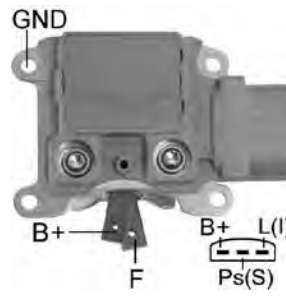

VR-F786BH

- *With Brush Holder
- *W/O LRC
- *Voltage Set Point:14.45V

Replaces

FORD : E0DZ-10316A,E9DF-10316AA
 MOTORCRAFT : GR801

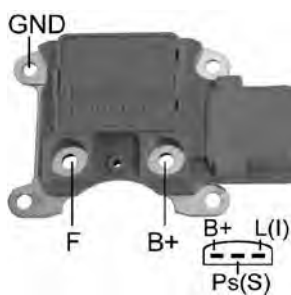

VR-F786H

- *Regitar No.:GR786
- *For Use on: Ford 2G, 3G Alternators
- *Voltage Set Point:14.45V

Replaces

FORD : E0DZ-10316A, E9DF-10316AA
 MOTORCRAFT : GR801

Unit No.

FORD : F02Z-10346C,F07F-10300AA,F07U-10300AC...



VR-F786HB

- *Short Circuit Protected
- *For Use on: Ford 2G, 3G 220A Alternators
- *Voltage Set Point: 14.45V

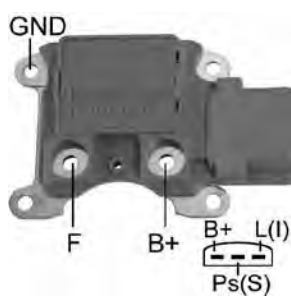

VR-F786HC

The VP4L2U-10316-AA Looks Like the Older F0DU-10316-AA, Except the Switching Speed of This Regulator is Faster. This Regulator Can Be Used in Place of the Older F0DU-10316-AA (8050-510), BUT Do NOT USE the 8050-510 to Replace the 8050-515.

Replaces

FORD : VP4L2U-10316AA
 MOTORCRAFT : GR801

Brush Holder

Voltage Regulator

Repair Circuit

Rectifier

Diode Trio

Diode

Tester

Brush Holder

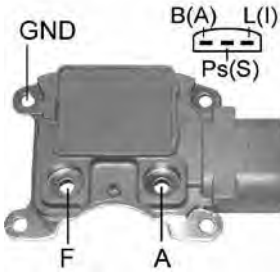

VR-F786M

*Regitar No.:GR786M
 *Short Circuit Protected
 *For Use on: Ford 2G, 3G
 Alternators
 *Voltage Set Point: 14.7V

Replaces

FORD : E9DF-10316AA,F0DZ-10316A
MOTORCRAFT : GR801

Unit No.

FORD : F0Z2-10346C,F07F-10300AA,F07U-10300AC...

Voltage Regulator



VR-F786SE

*Self Exciting
 *Voltage Set Point: 14.6V

Replaces

FORD : E0DZ-10316A,E9DF-10316AA

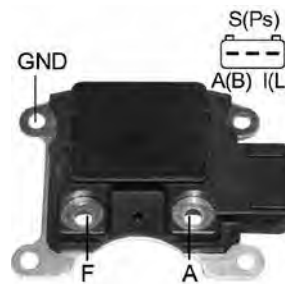

VR-F811

*Regitar No.:GR811
 *For Use on: Ford 3G
 Alternators
 *Voltage Set Point:14.7V

Replaces

FORD : F3AZ-10316A,F3AZ-10346A,F3RU-10316AA,GR811...

Unit No.

FORD : F3AU-10300CA

Repair Circuit

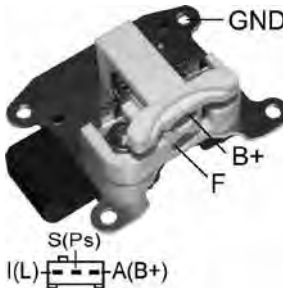

VR-F811BH

*With Brush Holder
 *For Use on: Ford 3G
 Alternators
 *Voltage Set Point:14.7V

Replaces

FORD : F3AZ-10316A ,F3AZ-10346A ,F3RU-10316AA

Unit No.

FORD : F3AU-10300CA

Rectifier

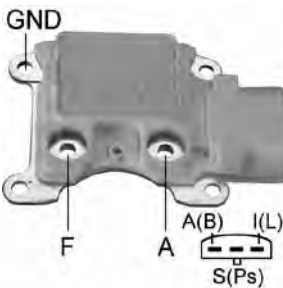

VR-F814

*Regitar No.:GR814
 *Soft Start
 *10 Sec. LRC
 *For Use on: Ford 3G
 Alternators
 *Voltage Set Point:14.7V

Replaces

FORD : F4ZZ-10316A
MOTORCRAFT : GR814

Unit No.

FORD : F4DU-10300CA,F4DU-10300DA,FD3U-10300CA...

Diode Trio



VR-F815

*Regitar No.:GR815
 *Soft Start
 *10 Sec. LRC
 *For Use on: Ford 4G
 Alternators
 *Voltage Set Point:14.7V

Replaces

FORD : F50U-100359AA,F50U-10316A,F50U-10C359AB
MOTORCRAFT : GR815

Unit No.

FORD : F5DU-10300DB,F50U-10300FA,F6DU-10300BB...

Diode

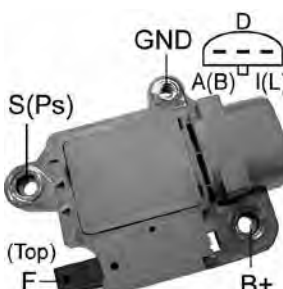

VR-F817

*Regitar No.: GR817
 *For Use on: Ford 4G
 Alternators
 *With Short Circuit Protected
 *Voltage Set Point:14.7V

Replaces

FORD : F6DU-10C359AA,F6DY-10316A,GR817

Unit No.

FORD : F6LU-10300CA,F6ZU-10300BC,F77U-10300AB

Tester

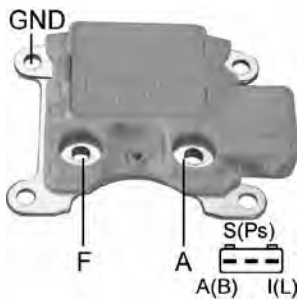

VR-F818

- *Regitar No.:GR818
- *Soft Start
- *6 sec. LRC
- *For Use on: 3G Alternators
- *Voltage Set Point:14.5V

Replaces

FORD : F4RU-10316AA,F5RU-10316A,F5RU-10316BA...
MOTORCRAFT : GR818,GR819

Unit No.

FORD : 94BB-10300AE,F4PU-10300AA,F5RU-10300BA...



VR-F821

- *Soft Start
- *6 Sec. LRC
- *Short Circuit Protected
- *Voltage Set Point:14.4V
- *Regitar No.: GR821

Replaces

FORD : VP4L2U-10C359AA

Unit No.

FORD : 6C2T-10300EB, 6C2Z-10346EA

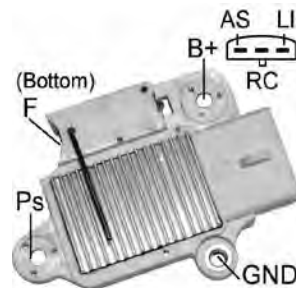

VR-F822

- *Regitar No.:GR822
- *Voltage Set Point:14.0V
- *Regulated Voltage Control(RVC)
- *Requires RVC01 tester box for testing

Replaces

FORD : VP6L8U-10C359AA



VR-F900

- *Regitar No.:GR900
- *L Terminal Does not Drive Choke
- *Gray Cover
- *Voltage Set Point:14.5V

Replaces

FORD : F8WU-10C359AB

Unit No.

FORD : F81U-10300BC,F81U-10300CC,F81U-10300DB...



VR-F901

- *Regitar No.: GR901
- *Soft Start
- *Short Circuit Protection
- *w/green cover
- *Voltage Set Point:14.2V

Replaces

FORD : VP3C3U-10C359AA

Unit No.

FORD : 1R3U-10300AA,1R3U-10300AD,2C3U-10300BB...

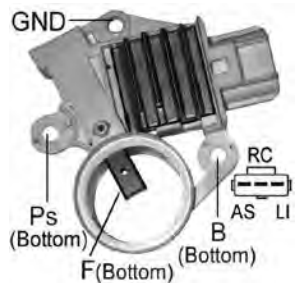

VR-F910

- *A-Circuit
- *w/gray cover
- *Voltage Set Point:14.3V
- *Regulated Voltage Control(RVC)
- *Requires RVC01 tester box for testing

Replaces

FORD : VP4L3U-10C359AA,VPF1U-10C359AA, XW4U-10C359AB

Unit No.

FORD : 1L8U-10300AB,1L8U-10300AC,1L8Z-10346AB...



VR-F911

- *S-FR-L Terminals
- *Soft Start
- *8.5 Second LRC
- *Short Circuit Protected
- *Voltage Set Point:14.5V

Unit No.

FORD : 2C1T-10300BB,2T1U-10300CA,2T1U-10300CB...
LUCAS : LRA2852

VISTEON : 20-150-01009

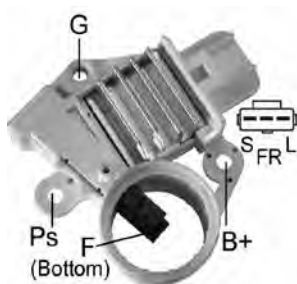

VR-F920

- *Regitar No.:GR920
- *w/white cover
- *Voltage Set Point:14.5V

Replaces

FORD : XS7U-10C359AC

Unit No.

FORD : 98BB-10300CC,XS8Z-10346BB



VR-F930

- *Regitar No.:GR930
- *w/orange cover
- *Voltage Set Point:14.5V

Replaces

FORD : XS7U-10C359BA

Unit No.

FORD : 1L8U-10300CD,1L8U-10300DD,1L8Z-10346CB...



VR-F931

*Regitar No.: GR931M
 *Voltage Set Point:14.4V

Replaces

FORD : VP4L1U-10C359AA

Unit No.

FORD :
 3L7Z10346AA,3L7Z10346BA,
 GL550

Brush Holder

Voltage Regulator



Repair Circuit

Rectifier

Diode Trio

Diode

Tester

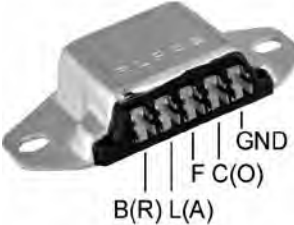
 <p>VR-H2001-1 *24V *Voltage Set Point:28.3V</p> <p>Replaces HINO : 27700-1480A,5140300610</p> <p>F B GND L IG</p>	 <p>VR-H2001-2 *24V *Voltage Set Point:28.3V</p> <p>Replaces HINO : 27700-1210B,5140500411</p> <p>F L GND A B</p>
 <p>VR-H2001-3 *24V *R-L-F-C-E Terminals *Voltage Set Point:28.3V</p> <p>GND F C(O) B(R) L(A)</p>	<p>Replaces HINO : 27700-1370,27700-1510 KOMATSU : 21J17 NISSAN : 23500-99005 SAWAFUJI : 1219-004-00,1219-005-00,1291-004-00X0 TOSHIBA : S5476A</p> <p>Unit No. HINO : 27040-1072,27040-1091,27040-1101... NISSAN : 23100-96074,23100-96075,23100-96077... SAWAFUJI : 0214-102-0011,0214-102-0021...</p>

- Brush Holder
- Voltage Regulator
- Repair Circuit
- Rectifier
- Diode Trio
- Diode
- Tester

**VR-H2000-1**

*B-S-L-F-E Terminals
 *VR-H2000-1H(14V): Heavy Duty
 *VR-H2000-1L(Volts Setting: 14.4V)
 *Voltage Set Point:14.7V

Replaces

BOSCH : 0-986-192-026,0-986-192-036
 HITACHI : TR1Z-27,TR1Z-33,TR1Z-47,TR1Z-48,TR1Z-56...
 LUCAS : 21511113
 MAGNETI MARELLI : 940038078,940038089
 NISSAN : 23215-B9800,23215-F2500,23215-P2500...
 SUBARU : 42990-7100,49575-7101,49575-7301

Unit No.

HITACHI : LR135-44,LR135-61,LR135-61B,LR138-01...
 NISSAN : 23100-04M00,23100-10W01,23100-12G00...
 SUBARU : 23700-AA000,23700-AA020,42990-7320...

**VR-H2000-11**

*S-L Terminals
 *Voltage Set Point:14.5V

Replaces

HITACHI : L170-43151
 NISSAN : 23133-77A00

Unit No.

HITACHI : LR165-707,LR165-707B,LR170-707B...
 NISSAN : 23100-77A00

**VR-H2000-12**

*S-IG-L Terminals
 *Repair Circuit: VR-H2000-9S
 *Voltage Set Point:14.5V

Replaces

ISUZU : 8-94249-860-0
 LUCAS : 21511109,UCJ126

Unit No.

HITACHI : LR150-703
 ISUZU : 8-94413-621-0

**VR-H2000-13**

*S-L Terminals
 *Repair Circuit: VR-H2000-13S
 *Voltage Set Point:14.5V

Replaces

HITACHI : L170-6315

Unit No.

HITACHI : LR160-703,LR170-706
 SUBARU : 9202-0644

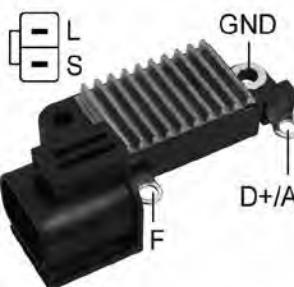
**VR-H2000-14**

*S-L Terminals
 *Repair Circuit: VR-H2000-14S
 *Voltage Set Point:14.5V

Replaces

HITACHI : L170-33152
 NISSAN : 23215-50Y05

Unit No.

HITACHI : LR165-708B,LR170-738,LR170-738B...
 NISSAN : 23100-50Y05,23100-50Y07,23100-OE700...

**VR-H2000-15**

*S-IG-D-L Terminals
 *Repair Circuit: VR-H2000-15S
 *Voltage Set Point:14.5V

Replaces

HITACHI : L170-23152
 SUBARU : 23815-AA010

Unit No.

HITACHI : LR170-732B,LR170-732C
 SUBARU : 23700-AA090

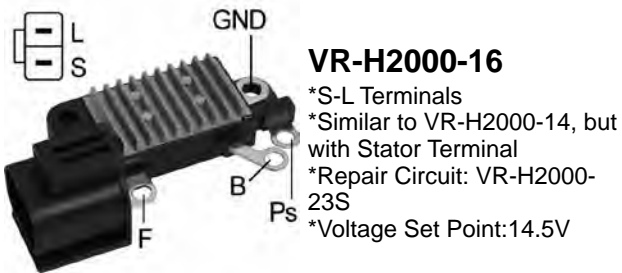
**VR-H2000-16**

*S-L Terminals
 *Similar to VR-H2000-14, but with Stator Terminal
 *Repair Circuit: VR-H2000-23S
 *Voltage Set Point:14.5V

Replaces

HITACHI : L180G-2340,L165G-2315,L180G-6340,L180G-7340
NISSAN : 23215-85L00,23215-0C001,23215-70T00

Unit No.

HITACHI : LR165-708C,LR170-738C,LR170-744...
NISSAN : 23100-0C000,23100-0E700,23100-0E705...

**VR-H2000-17**

*S-L Terminals
 *Voltage Set Point:14.5V

Replaces

HITACHI : L180-8315
NISSAN : 23215-64J00

Unit No.

HITACHI : LR160-723,LR160-723B,LR170-734...
NISSAN : 23100-12G02,23100-64J00,23100-80G08...

**VR-H2000-18**

*S-L Terminals
 *Repair Circuit: VR-H2000-18S
 *Voltage Set Point:14.5V

Replaces

HITACHI : L180-5340,L180G-9340
NISSAN : 23215-64J01,23215-64J00,23215-64J02

Unit No.

HITACHI : LR160-724,LR170-739B,LR180-725...
NISSAN : 23100-64J01

**VR-H2000-19**

*S-L Terminals
 *Voltage Set Point:14.5V

Replaces

HITACHI : L165-5315
SUBARU : 23733-A0010,23733-AA010

Unit No.

HITACHI : LR165-704B,LR165-705
SUBARU : 23700-AA150

**VR-H2000-1H**

*Heavy Duty
 *Voltage Set Point:14.4V

Replaces

BOSCH : 0-986-192-026,0-986-192-036
HITACHI : TR1Z-27,TR1Z-33,TR1Z-47,TR1Z-48,TR1Z-56...
NISSAN : 23215-B9800,23215-F2500,23215-P2500...
SUBARU : 42990-7100,49575-7101,49575-7301

Unit No.

HITACHI : LR135-44,LR135-61,LR135-61B,LR138-01...

**VR-H2000-1L**

*Voltage Setting: 14.4V

Replaces

BOSCH : 0-986-192-026,0-986-192-036
HITACHI : TR1Z-27,TR1Z-33,TR1Z-47,TR1Z-48,TR1Z-56...
NISSAN : 23215-B9800,23215-F2500,23215-P2500...
SUBARU : 42990-7100,49575-7101,49575-7301

**VR-H2000-2**

*R-R-L-F-E Terminals
*Voltage Set Point:14.5V

Replaces

HITACHI : TR1Z-44,TR1Z-63
ISEKI : 6581-270-004-0
ISUZU : 5-81270-004-0
SUBARU : 49575-5601
YANMAR : 0124080-77390,XTR1Z-44,XTR1Z-63

Unit No.

HITACHI : LR120-15C,LR120-23,LR135-105,LR135-115...
ISEKI : 581-200-338-0,581-200-338-1...
ISUZU : 5-00181-010-0,5-81200-338-0...
YANMAR : 0121400-77201,128270-77200,129772-77200...

**VR-H2000-20**

*S-L Terminals
*Voltage Set Point:14.5V

Replaces

HITACHI : L190-4315
NISSAN : 23133-F6500

Unit No.

HITACHI : LR170-710B,LR180-705B,LR180-708...
NISSAN : 23100-16N00,23100-30P00,23100-59S01...

**VR-H2000-21**

*S-L Terminals
*Voltage Set Point:14.5V

Replaces

HITACHI : L170-3315
NISSAN : 23133-13E00

Unit No.

HITACHI : LR160-708,LR160-709,LR160-710
NISSAN : 23100-02E00,23100-02E05

**VR-H2000-23**

*S-L Terminals
*Voltage Set Point:14.5V

Replaces

HITACHI : L195G-2340
NISSAN : 23215-97E01

Unit No.

HITACHI : LR195-701
NISSAN : 23100-97E01

**VR-H2000-24**

*S-IG-L Terminals
*Voltage Set Point:14.5V

Unit No.

HITACHI : LR150-711,LR160-725,LR160-726

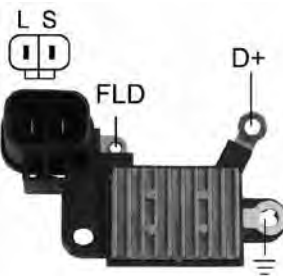
**VR-H2000-26**

*S-L Terminals
*Voltage Set Point:14.5V

Replaces

HITACHI : L1110-2315
NISSAN : 23100-60U00

Unit No.

NISSAN : 23100-60U00

**VR-H2000-27**

*Repair Circuit:VR-H2000-28S
*S-L Terminals
*Voltage Set Point:14.5V

Replaces

HITACHI : L185G-4340
SUBARU : 23815-AA050

Unit No.

HITACHI : LR190-724
NISSAN : 23100-70F05

**VR-H2000-28**

*S-L Terminals
*Short Circuit Protection
*Repair Circuit:VR-H2000-28S
*Voltage Set Point:14.5V

Replaces

HITACHI : L1100G-3340,L1100G-9340
NISSAN : 23215-31U05

Unit No.

HITACHI : LR1110-705
NISSAN : 23100-31U01,23100-31U02

**VR-H2000-29**

*IG-L-S Terminals
*Voltage Set Point:14.5V

Replaces

GM : 94167410
HITACHI : L150-33155
ISUZU : 8-94167-410-0
VALEO : A556536A

Unit No.

HITACHI : LR150-415,LR150-421C,LR150-431...
ISUZU : 8-94122-488-4,8-94128-056-2...

**VR-H2000-29A-2**

*IG-L-S Terminals
*Voltage Set Point:14.5V
*With Capacitor

Replaces

GM : 94167410
HITACHI : L150-33155
ISUZU : 8-94167-410-0
VALEO : A556536A

Unit No.

HITACHI : LR150-415,LR150-421C,LR150-431...
ISUZU : 8-94122-488-4,8-94128-056-2...

**VR-H2000-29B**

*24V
*IG-L-S Terminals
*Voltage Set Point:28.3V

Replaces

HITACHI : TR2Z-49,L225-8315
ISUZU : 8-94156590-0
NISSAN : 23215-C6800

Unit No.

HITACHI : LR270-05
NISSAN : 23100-17D60

**VR-H2000-29BA-2**

*24V
*IG-L-S Terminals
*Voltage Set Point:28.3V
*With Capacitor

Replaces

HITACHI : TR2Z-49,L225-8315
ISUZU : 8-94156590-0
NISSAN : 23215-C6800

Unit No.

HITACHI : LR270-05
NISSAN : 23100-17D60

**VR-H2000-29BC**

*24V
*IG-L-S Terminals
*W/ integral design frame
*Voltage Set Point:28.3V

Replaces

HITACHI : TR2Z-49,L225-8315
ISUZU : 8-94156590-0
NISSAN : 23215-C6800

Unit No.

HITACHI : LR270-05
NISSAN : 23100-17D60

**VR-H2000-29C**

*IG-L-S Terminals
*W/ integral design frame
*Voltage Set Point:14.5V

Replaces

GM : 94167410
GM : 94167410
HITACHI : L150-33155
ISUZU : 8-94167-410-0
VALEO : A556536A

Unit No.

HITACHI : LR150-415,LR150-421C,LR150-431...
ISUZU : 8-94122-488-4,8-94128-056-2...

**VR-H2000-2B**

*24V
*R-R-L-F-E Terminals
*Active lamp
*Voltage Set Point:28.3V

Replaces

HITACHI : TR2Z-47
ISUZU : 5-81251-016-0
NISSAN : 23500-99008
YANMAR : 119129-77820

Unit No.

HITACHI : LR215-50,LR220-23,LR220-24,LR225-84T...
ISUZU : 1-81200-393-1,1-81200-401-0...
NISSAN : 23099-Z5518,23099-Z5560,23099-Z5561...
YANMAR : 119129-77201,129535-77200

**VR-H2000-3**

*B-S-R-L-F-E Terminals
*Voltage Set Point:14.5V

Replaces

BOSCH : 0-986-192-030
DELCO REMY (LUCAS) : 21511114
HITACHI : TR1Z-43,TR1Z-53,TR1Z-62,TR1Z-64,136284
ISUZU : 8-94237-720-0,8-94250-964-0,8-94250-968-0
MAZDA : RF01-24-520,S208-24-520
NISSAN : 23215-54A00,23215-W1700,23215-W1701

Unit No.

HITACHI : LR140-130B,LR140-130P,LR140-131...
ISUZU : 8-94155-308-5,8-94155-309-5...
NISSAN : 23099-29W00,23099-36W01,23099-36W02...

**VR-H2000-30**

*S-L Terminals
*Voltage Set Point:14.5V

Replaces

HITACHI : L150-93155,L160-63153
NISSAN : 23528-18G01,23528-V7200

Unit No.

HITACHI : LR140-415B,LR140-419,LR140-419T...
NISSAN : 23100-02N20,23100-11T16,23100-43G08...

**VR-H2000-32**

*S-L Terminals
*Voltage Set Point:14.7V

Replaces

BOSCH : 0-986-192-026,0-986-192-036
HITACHI : TR1Z-27,TR1Z-28,TR1Z-33,TR1Z-47,TR1Z-48...
LUCAS : 21511113
MAGNETI MARELLI : 940038078,940038089
NISSAN : 23215-B9800,23215-F2500,23215-P2500...
SUBARU : 42990-7100,49575-7101,49575-7301

Unit No.

HITACHI : LR135-44,LR135-61,LR135-61B,LR138-01...
NISSAN : 23100-04M00,23100-10W01,23100-12G00...
SUBARU : 23700-AA000,23700-AA020,42990-7320...

**VR-H2000-33**

*Voltage Set Point:14.5V

Replaces

HITACHI : L135-13152

Unit No.

HITACHI : LR135-105,
LR135-106,LR135-126

**VR-H2000-34**

*Voltage Set Point:14.5V

Replaces

HITACHI : L135-43153

Unit No.

HITACHI : LR120-23,
LR135-104,LR135-125,
LR135-127...

**VR-H2000-35**

*Voltage Set Point:14.5V

Replaces

HITACHI : L150-23155
NISSAN : 23528-29W00

Unit No.

HITACHI : LR155-16P,LR155-408

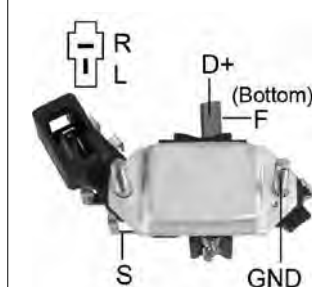
**VR-H2000-36**

*Voltage Set Point:14.5V

Replaces

HITACHI : L150-73154

Unit No.

HITACHI : LR140-406,
LR140-410F,LR140-423F...

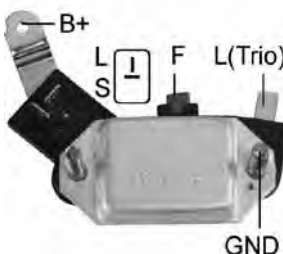
**VR-H2000-37**

*Voltage Set Point:14.7V

Replaces

BOSCH : 0-986-192-028
HITACHI : L150-43151,L150-63151
NISSAN : 23133-D0200,23133-Q4601,23133-W1606...

Unit No.

HITACHI : LR150-100,LR150-101B,LR150-125B...
NISSAN : 23100-01N06,23100-27G00

**VR-H2000-38**

*Repair Circuit:VR-H2000-38S
*W/o Overvoltage/
Undervoltage indication
*W/o Short Circuit Protection
*Voltage Set Point:14.5V

Replaces

HITACHI : L170G-6315,L180G-23401
NISSAN : 22020-85M10,23215-0M801,23215-0W401

Unit No.

HITACHI : LR165-711,LR165-711B,LR170-743...



VR-H2000-39

- *S-L Terminals
- *Soft Start
- *2.5 sec. LRC
- *Voltage Set Point:14.5V

Replaces

- HITACHI : TR1Z-108,TR1Z-108B
- Unit No.**
- HITACHI : LR170-501C,LR170-502B,LR170-502C...



VR-H2000-3A

- *24V
- *B-S-R-L-F-E Terminals
- *Voltage Set Point:28.3V

Replaces

- HITACHI : TR2Z-37,TR2Z-49
- ISUZU : 8-94156-595-0
- NISSAN : 23215-C6800
- Unit No.**
- HITACHI : LR225-403,LR225-407,LR225-408E...
- ISUZU : 8-94122-267-3,8-94336-728-0...
- NISSAN : 23099-C6808,23099-C8600,23099-R8111...



VR-H2000-40

- *Without capacitor
- *Voltage Set Point:14.5V

Replaces

- HITACHI : L170G-1315
- Unit No.**
- HITACHI : LR170-420

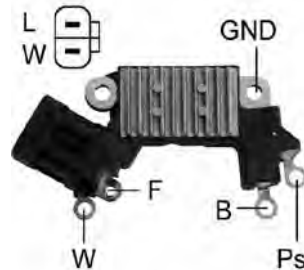

VR-H2000-41

- *L-W Terminals
- *Repair Circuit:VR-H2000-41S
- *Voltage Set Point:14.5V

Replaces

- HITACHI : L170G-3319,L170G-6308,L170G-7315



VR-H2000-42

- *L-S Terminals
- *Same as VR-H2000-38 but W/Brush Holder
- *Voltage Set Point:14.5V

Replaces

- HITACHI : L170G-6315,L180G-23401,L190G-7340
- NISSAN : 22020-85M10,23215-0M810,23215-5V100
- Unit No.**
- HITACHI : LR165-711,LR165-711B,LR170-743...

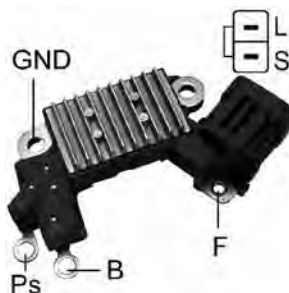

VR-H2000-43

- *L-S Terminals
- *Soft Start
- *4.5 sec. LRC
- *Short Circuit Protection
- *Voltage Set Point:14.2V

Replaces

- HITACHI : L190G-5340
- NISSAN : 23215-0W402
- Unit No.**
- HITACHI : LR180-751,LR190729,LR190737,LR190737E
- NISSAN : 23100-0W000,23100-0W001,23100-0W002...

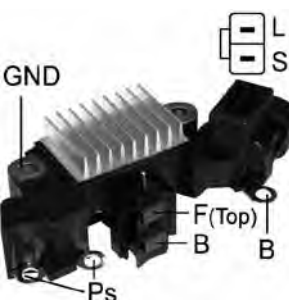

VR-H2000-44

- *L-S Terminals
- *Repair Circuit: VR-H2000-44S
- *2.5 sec. LRC
- *Short Circuit Protection
- *Voltage Set Point:14.5V
- Unit No.**
- HITACHI : LR1100-722, LR180-756B
- NISSAN : 23100-3S500, 23100-4S100,23100-9E000



VR-H2000-45

- *L-S Terminals
- *Same as VR-H2000-44 but LRC=8.5sec
- *For use on NISSAN SENTRA 180
- *Voltage Set Point:14.5V

Unit No.

- HITACHI : LR180-769
- NISSAN : 21300-4Z400

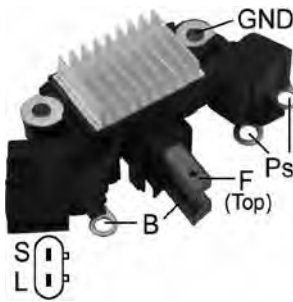
**VR-H2000-46**

- *S-L Terminals
- *Inactive Lamp
- *Soft Start
- *8.5 sec. LRC
- *Short Circuit Protection
- *Voltage Set Point:14.5V

Replaces

HITACHI : L1100G-53402,L1100G-8340,L1100G-43402
NISSAN : 23100-2Y000,23215-2Y005,23215-0L701...

Unit No.

HITACHI : LR1100-711B,LR1110-707G,LR1110-709B...

**VR-H2000-47**

- *Voltage Set Point:14.5V

Replaces

HITACHI : L170G-1315
MAGNETI MARELLI : 940038067

**VR-H2000-47C**

- *W/ integral design frame
- *Voltage Set Point:14.5V

Replaces

HITACHI : L170G-1315
MAGNETI MARELLI : 940038067

**VR-H2000-48**

- *Soft Start
- *4.5 sec. LRC
- *Short Circuit Protection
- **"C" Terminal connect to Computer
- *Voltage Set Point: 14.6V

Replaces

HITACHI : 234289

Unit No.

HITACHI : LR160-630C,LR160-729C,LR160-730C...
ISUZU : 2-90276-600-0,8-97101-816-2...

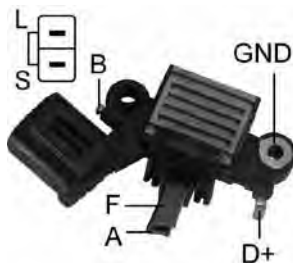
**VR-H2000-4H**

- *L-S Terminals
- *Voltage Set Point:14.5V
- *w/o capacitor

Replaces

HITACHI : L180-3315,L190-3315
NISSAN : 23133-16E05,23133-F6100

Unit No.

HITACHI : LR170-704,LR170-713,LR170-721,LR180-704...

**VR-H2000-50**

- *L-W Terminals
- *Soft Start
- *2.5 sec. LRC
- *Short Circuit Protection
- *Voltage Set Point:14.4V

Replaces

HITACHI : 232443

Unit No.

HITACHI : LR1100-502F,LR170-509E,LR170-511
ISUZU : 8-97189-112-3,8-97189-113-4

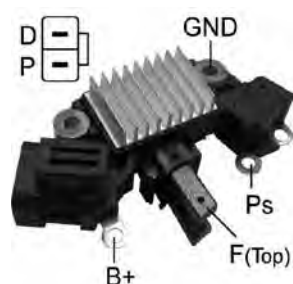
**VR-H2000-51**

- *P-D Terminals
- **Traditional test method will immediately damage P-D regulator. Avoid damage using Mobiletron VR-H2009-66TF test fixture

Unit No.

HITACHI : LR170-758

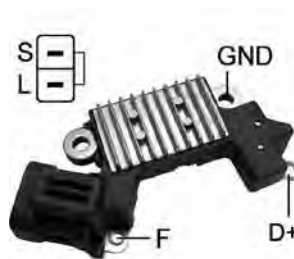
**VR-H2000-52**

- *S-L Terminals
- *Repair Circuit: VR-H2000-52S
- *Voltage Set Point:14.3V

Unit No.

KIA : OK012-18300,OK241-18300,OK012-18300...

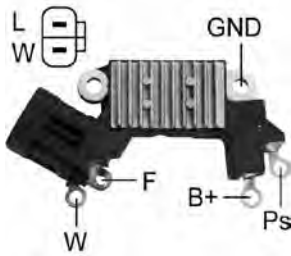

VR-H2000-53

*Same as VR-H2000-41 but with Over/Under Voltage Indication

Replaces

HITACHI : L170G-3319,L170G-6308,L170G-7315

VR-H2000-56

*L Terminal Does Not Drive Choke
 *Load Response Control
 *Soft Start
 *Short Circuit Protection
 *Voltage Set Point:14.2V

Unit No.

HITACHI : LR180-509C,LR180-510
ISUZU : 29027-68100,89711-66973,89718-95490...

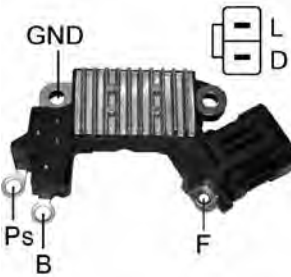

VR-H2000-55B

*24V
 *L Terminal Does Not Drive Choke
 *Repair Circuit: VR-H2000-55S
 *Voltage Set Point:28.5V

Unit No.

HITACHI : LR250-502C, LR250-507,LR250-507C
ISUZU : 8-97075-883-2, 8-97148-496-0...



VR-H2000-57

*S-L Terminals
 *Soft Start
 *Short Circuit Protection
 *Voltage Set Point:14.3V

Unit No.

HITACHI : LR165-713



VR-H2000-5H

*L-S Terminals
 *Repair Circuit: VR-H2000-5S
 *Voltage Set Point:14.5V

Replaces

HITACHI : L160-43154,L170-53151
NISSAN : 23133-58S00,23133-58S01,23133-D4400

Unit No.

HITACHI : LR160-715,LR170-715,LR170-715B...
NISSAN : 23100-53A00

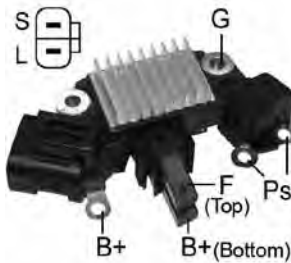

VR-H2000-62

*A-Circuit
 *Inactive Lamp
 *S-L Terminals
 *Soft Start
 *Short Circuit Protection
 *Voltage Set Point: 14.3V

Replaces

HITACHI : L180G-63401,L185G-5340,L190G-8340
SUBARU : 23812-AA000

Unit No.

GM : 977202264
HITACHI : LR1100-705E,LR1100-710,LR1100-710B...
ISUZU : 29027-68300,89720-43320,29027-68200...
NISSAN : 23100-2W400,23100-3W400,23100-8J000...

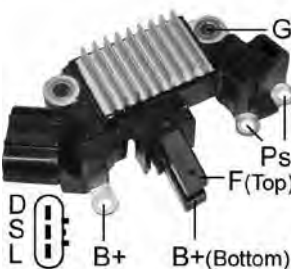

VR-H2000-63

*D-S-L Terminals
 *Soft Start
 *8.5 sec. LRC
 *Short Circuit Protection
 *Voltage Set Point: 14.3V

Unit No.

HITACHI : LR190-742
SUBARU : 23700-AA31A

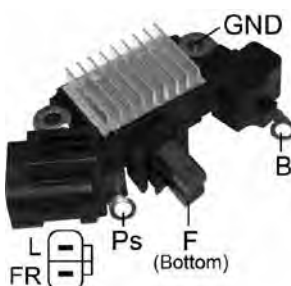

VR-H2000-64

* L-FR Terminals
 * L Terminals Does Not Drive Choke
 * W/ Short Circuit Protection
 * Soft Start
 * 2.5 sec LRC
 * Voltage Set Point: 14.3V

Replaces

OPEL : 13117236,13153236,135546130,135546140...
SAAB : 12759595

Unit No.

HITACHI : LR1100-508,LR1100-508B,LR1100-508C...



VR-H2000-65
 *IG-L-S Terminals
 *Repair Circuit: VR-H2000-9S
 *Voltage Set Point: 14.6V

Replaces
HITACHI : L180G-2315
Unit No.
HITACHI : LR180-502R,LR180-501,LR180-501B...

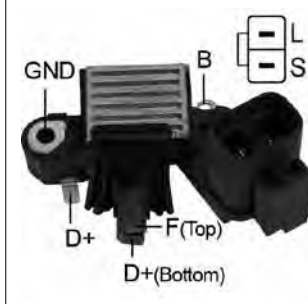

VR-H2000-6H
 *S-L Terminals
 *Repair Circuit: VR-H2000-13S
 *Voltage Set Point: 14.5V

Replaces
HITACHI : L170-1315
NISSAN : 23133-04P01
Unit No.
HITACHI : LR170-701, LR170-701B,LR170-702...
NISSAN : 23100-05P01,23100-05P03,23100-14P01...



VR-H2000-70B
 *24V
 *Soft Start
 *Short Circuit Protection
 *Voltage Set Point: 28.5V

Unit No.
HITACHI : LR280-501, LR280-506,LR280-508
ISUZU : 8-97248-914-1, 8-97332-502-0...



VR-H2000-71
 *Soft Start
 *Short Circuit Protection
 *S Open Lamp Off
 *Voltage Set Point: 14.5V

Unit No.
HITACHI : LR1110-501



VR-H2000-72
 *Voltage Set Point: 14.5V

Unit No.
HITACHI : LR140-721,LR140-721B,LR140-721C
YANMAR : 129930-77211



VR-H2000-73
 *Soft Start
 *Short Circuit Protection
 *Voltage Set Point: 14.3V
 *Regulated Voltage Control(RVC)
 *Requires RVC01 tester box for testing

Unit No.
HITACHI : LR1110-724, LR1110-724B



VR-H2000-74
 *L-S Terminals
 *Soft Start
 *Short Circuit Protection
 *Voltage Set Point: 14.5V

Unit No.
HITACHI : LR1100-715

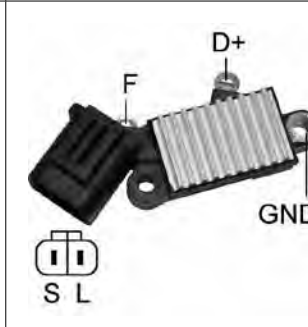

VR-H2000-75B
 *24V
 *Voltage Set Point: 28.5V

Unit No.
NISSAN : 23100-0T002



VR-H2000-76B
 *24V
 *Soft Start
 *Short Circuit Protection
 *Voltage Set Point: 28.5V

Unit No.
HITACHI : LR250-517
ISUZU : 897351-5720

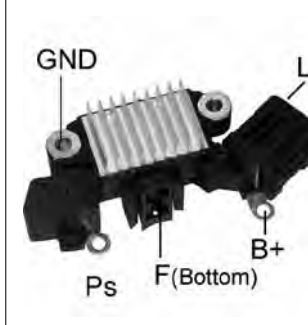

VR-H2000-76BA
 *24V
 *Soft Start
 *Short Circuit Protection
 *w/o Brushes
 *Voltage Set Point: 28.5V

Replaces
NIKKO : 0-35719-0260
Unit No.
NIKKO : 8-98013-455-1



VR-H2000-7H
 *S-L Terminals
 *Voltage Set Point: 14.5V
 *w/capacitor

Replaces
HITACHI : L180-7315
NISSAN : 23133-26E60
Unit No.
HITACHI : LR170-721B, LR180-721B,LR190-704B...



VR-H2000-8
 *S-L Terminals
 *Voltage Set Point: 14.5V

Replaces
HITACHI : TR1Z-210A, TR1Z-210B
Unit No.
HITACHI : LR155-502B, LR155-502C,LR155-502E...

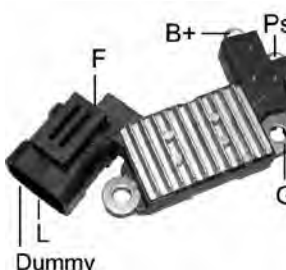

VR-H2000-80B
 *24V
 *Soft Start
 *Short Circuit Protection
 *Voltage Set Point 28.4V
Unit No.
HITACHI : LR250-508,LR250-707



VR-H2000-80BA
 *24V
 *Soft Start
 *Short Circuit Protection
 *Voltage Set Point 28.4V
 *With Capacitor
Unit No.
HITACHI : LR250-508,LR250-707



VR-H2000-84
 *S-L Terminals
 *Soft Start
 *2.5 sec. LRC
 *Short Circuit Protection
 *Voltage Set Point:14.3V
Unit No.
HITACHI : LR1110-713V, LR1110-713C
NISSAN : 23100-AU400, 23100-AU40D,23100-JA02C

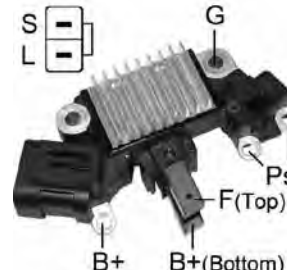

VR-H2000-85
 *S-L Terminals
 *Soft Start
 *8.5 sec. LRC
 *Short Circuit Protection
 *Voltage Set Point: 14.3V
Unit No.
HITACHI : LR1130-701
NISSAN : 23100-8S100, 23100-8S10A



VR-H2000-86B
 *24V
 *Voltage Set Point: 28.5V
 *Same as VR-H2000-55 w/ brush holder
Unit No.
HITACHI : LR250-502C, LR250-507,LR250-507C
ISUZU : 8-97075-883-2, 8-97148-496-0...



VR-H2000-87
 *Voltage Set Point: 14.4V
Unit No.
HITACHI : LR1140-803E,LR190-772,LR190-773
NISSAN : 23100-ED50A



VR-H2000-88
 *Soft Start
 *Short Circuit Protection
 *S Open Lamp On
 *Voltage Set Point: 14.3V
Replaces
HITACHI : L180G-63401,L190G-8340
NISSAN : 23215-0V000,23215-2J602
Unit No.
HITACHI : LR1110-713C
NISSAN : 23100-AU400

VR-H2000-89
 *Voltage Set Point: 14.3V
 *Soft Start
 *Short Circuit Protection
 *Regulated Voltage Control(RVC)
 *Requires RVC01 tester box for testing
Unit No.
HITACHI : LR1130-703,LR1130-703A,LR1130-703B
NISSAN : 23100-EA200,23100-EA20A



VR-H2000-89
 *Voltage Set Point: 14.3V
 *Soft Start
 *Short Circuit Protection
 *Regulated Voltage Control(RVC)
 *Requires RVC01 tester box for testing
Unit No.
HITACHI : LR1130-703,LR1130-703A,LR1130-703B
NISSAN : 23100-EA200,23100-EA20A

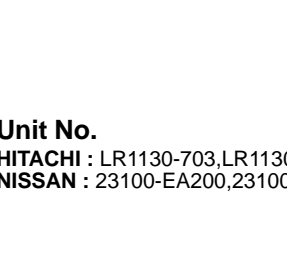

VR-H2000-91
 *Soft Start
 *Short Circuit Protection
 *Voltage Set Point: 14.3V
 *Regulated Voltage Control(RVC)
 *Requires RVC01 tester box for testing
Unit No.
HITACHI : LR1140-803,LR1140-806,LR1140-807
NISSAN : 23100-ED500



VR-H2000-9
 *S-IG-L Terminals
 *Repair Circuit: VR-H2000-9S
 *Voltage Set Point:14.5V
Replaces
ISUZU : 8-94462-849-0
Unit No.
HITACHI : LR150-704, LR150-704H,LR160-718...
ISUZU : 8-94136-210-0, 8-94449-265-0...

VR-H2000-91
 *Soft Start
 *Short Circuit Protection
 *Voltage Set Point: 14.3V
 *Regulated Voltage Control(RVC)
 *Requires RVC01 tester box for testing
Unit No.
HITACHI : LR1140-803,LR1140-806,LR1140-807
NISSAN : 23100-ED500

Brush Holder

Voltage Regulator

Repair Circuit

Rectifier

Diode Trio

Diode

Tester



VR-H2000-92B

- *24V
- *Soft Start
- *Short Circuit Protection
- *Voltage Set Point:28.0V

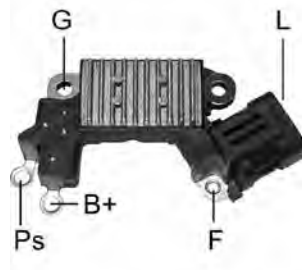

Unit No.
HITACHI : LR250-517



VR-H2000-94B

- *24V
- *Soft Start
- *Short Circuit Protection
- *Voltage Set Point: 28.4V

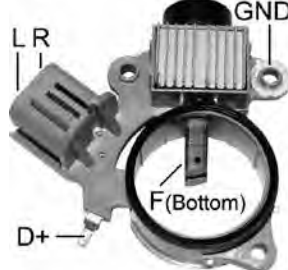
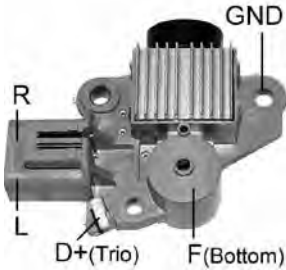
Replaces
ISUZU : 8-971860551-1
Unit No.
HITACHI : LR250-511

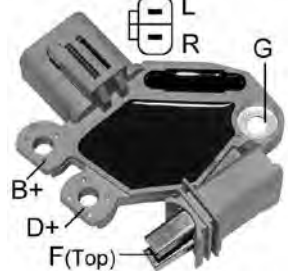
 <p>VR-H2009-187 *Voltage Set Point: 14.5V</p> <p>Replaces HYUNDAI : 37370-02500, 37370-21330,37370-24510 VALEO : TA500C0041</p> <p>Unit No. HYUNDAI : 37300-02500,37300-02503 MANDO : AB160108</p>	 <p>VR-H2009-192B *24V *Voltage Set Point: 28.4V</p> <p>Unit No. HYUNDAI : 37300-41750, 37300-41751</p>
 <p>VR-MD13B *24V *Voltage Set Point: 28.4V</p> <p>Replaces HYUNDAI : 37370-72000,3 7370-8Y020</p> <p>Unit No. KIA : OK87T-18300 MANDO : AB250474</p>	 <p>VR-MD14B *24V *Voltage Set Point: 28.4V</p> <p>Replaces MANDO : 37300-45001</p> <p>Unit No. HYUNDAI : 37300-45001 MANDO : AB240456</p>
<p style="text-align: center;">PICTURE IS NOT AVAILABLE</p> <p>VR-V018</p> <p>Unit No. HYUNDAI : 37300-2F100</p>	 <p>VR-V019B *L-R Terminals *24V *Voltage Set Point: 28.4V</p> <p>Unit No. HYUNDAI : 37300-48000</p>

- Brush Holder
- Voltage Regulator
- Repair Circuit
- Rectifier
- Diode Trio
- Diode
- Tester

Brush Holder

Voltage Regulator

Repair Circuit

Rectifier

Diode Trio

Diode

Tester



VR-IK01
 *Voltage Set Point:14.2V
Replaces
 ISKRA : 11-125-165,16-906-481
Unit No.
 ISKRA : 11201666,11201667,
 AAK5114,AAK5115

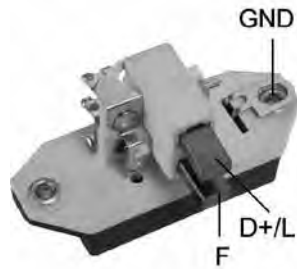

VR-IK019
 *32mm OD
 *Voltage Set Point:14.7V
Replaces
 ISKRA : 11125019,11125053,1112
 5054,11125056,11125065...
Unit No.
 ISKRA : 11201273,AAK1314



VR-IK02
 *Voltage Set Point: 14.6V
Replaces
 ISKRA : 11-125-124,16-906-352
Unit No.
 ISKRA : 11201440,11201498,
 11201534,11201769...

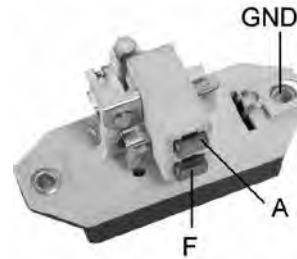

VR-IK029
 *24V
 *32mm OD
 *Voltage Set Point:28.3V
Replaces
 ISKRA : 11-125-029,11-125-
 047,11-125-087,16-905-304...
Unit No.
 ISKRA : 11201050,11201052,112
 01055,11201066...



VR-IK149
 *Voltage Set Point:14.2V
Replaces
 ISKRA : 11-125-122,11-125-
 149,11-201-293,AER1528...
 LADA : 21083701010,
 224370701,T2223701010
Unit No.
 ISKRA : AAK4127

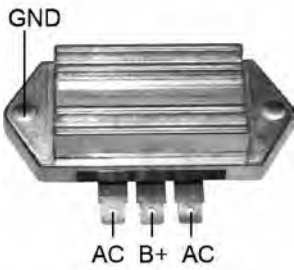

VR-IK15
 *W/module packed like Bosch
 OE design
 *Short Circuit Protection
 *Voltage Set Point: 14.2V
Replaces
 ISKRA : AER1603,11-125-124

 <p>VR-JD357 *Voltage Set Point: 14.5V</p> <p>Replaces JOHN DEERE : AM102596, AM123296,AM106357,AM34738</p>	

- Brush Holder
- Voltage Regulator
- Repair Circuit
- Rectifier
- Diode Trio
- Diode
- Tester

Brush Holder

Voltage Regulator

Repair Circuit

Rectifier

Diode Trio

Diode

Tester



VR-H2009-116

- * Inactive Lamp
- * S-L Terminals
- * Voltage Set Point:14.5V

Replaces

KIA : 0K201-18-300B,0K24A-18-300A,0K29T-18-300...
MANDO : AB170036,AB170066,A B180092,TA500C02001A...
VALEO : 234252



VR-K01

*Voltage Set Point:14.7V

Unit No.

POONG SUNG : 02121-8025,02121-8027,02121-8070...



VR-K01B

- *24V
- *Voltage Setting:28.3V

Unit No.

POONG SUNG : 02122-3030



VR-K02

*Voltage Set Point: 14.5V

Unit No.

HYUNDAI : 37300-12470
KIA : OK72A-18-300
POONG SUNG : 02131-9020,02131-9021

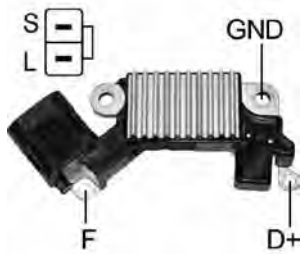

VR-K05

- *S-L Terminals
- *Voltage Set Point: 14.3V

Replaces

KIA : 37370-27011
POONG SUNG : 235522
Unit No.
HYUNDAI : 37300-27011,37300-27012,37300-27013...
POONG SUNG : 02131-9111,02131-9112,02131-9311...



VR-K09

- *Soft Start
- *2.5 sec. LRC
- *Voltage Set Point:14.6V

Replaces

DELCO : 220736

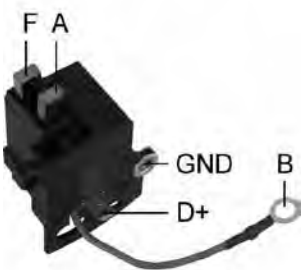
 <p>VR-LD150A *Voltage Set Point:14.5V</p> <p>Replaces LADA : 173701010, 21033701500,21053701500 LUCAS : 21129167,21229167,UCB900 MAGNETI MARELLI : 940038112</p> <p>Unit No. LADA : 2105-370-1010, 2205-370-1005</p>	 <p>VR-LD160 *Voltage Set Point:14.5V</p> <p>Replaces LADA : 173702,21083701500, 56-7-625/5,EP1 LUCAS : 21229189,UCB902</p>

- Brush Holder
- Voltage Regulator
- Repair Circuit
- Rectifier
- Diode Trio
- Diode
- Tester

Brush Holder

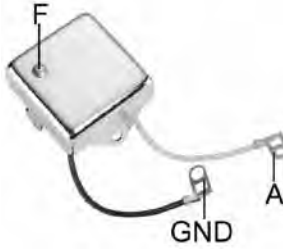

VR-LC100

*Voltage Set Point:14.5V

Replaces

BL/JAGUAR : 37H6911,520076,607687,AAU4842,ABU9969...
 BOSCH : 0-986-192-006
 LUCAS : 37534,37538,37541,37555,37558,37561,37565...
 MASSEY FERGUSON : 1887416M1,1897383M1
 MOTORCRAFT : EGR304,EGR351
 TALBOT : 75062449
 VALEO : 505044,505052,505096,A554616A,NB180
 VALEO(MOTOROLA) : 9RC7037

Unit No.

LUCAS : 23562,23563,23565,23566,23572,23581...

Voltage Regulator



VR-LC106

*L Terminal Does Not Drive Choke
 *Voltage Set Point:14.4V

Replaces

LUCAS : 26215045,SR30

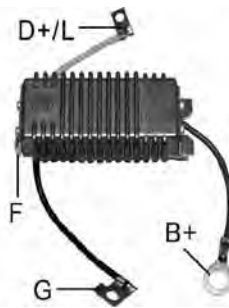

VR-LC107

*L Terminal Does Not Drive Choke
 *Voltage Set Point:14.4V

Replaces

LUCAS : 26938068B,TR15

Repair Circuit

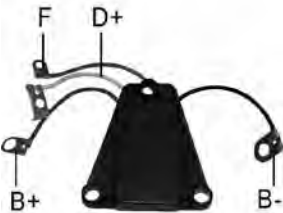

VR-LC108

*L Terminal Does Not Drive Choke
 *Voltage Set Point:27.8V

Replaces

LUCAS : 26938063A,SR40



VR-LC110

*L Terminal Does Not Drive Choke
 *Voltage Set Point:14.6V

Replaces

LUCAS : 26214105,GA15

Rectifier

Diode Trio



VR-LC111

*Voltage Set Point:14.5V

Replaces

CASE : K262266
 DELCO REMY (LUCAS) : 54048473
 FORD : 6133746,84AB-10316AA
 LUCAS : 37701,37703,37705,37707,54048473,54048600...
 MAGNETI MARELLI : 28000010,28000,28001
 MASSEY FERGUSON : 1865974M1,1897699M91,345773M91...
 NISSAN : 23133-Q9000
 PERKINS : 28710252
 ROVER : BAU4919,BAU5265,BAU5958,FBU2243,FBV2243...
 RVI : 5430021883
 VALEO : A554711A

Unit No.

LUCAS : 24145,24145AD,24156,24156AD,24157...
 NISSAN : 23100-71J00

Diode

Tester



VR-LC111B

*24V
 *Voltage Set Point:28.3V

Replaces

LUCAS : 28002,54022415,84959,UCB155
Unit No.
 LUCAS : 24299,24406,A127,NAB901, NAB903

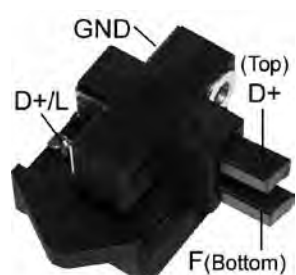

VR-LC112

*A-Circuit
 *Inactive Lamp
 *Voltage Set Point:14.3V

Replaces

LUCAS : 2193818A,SR60,26938161A
Unit No.
 LUCAS : 26021117,26021326, 84315400101,285001075



VR-LC113L
 *Voltage Set Point:12.5V

Replaces
FORD : E3NN-10B376AD, E7NN-10316AA
LUCAS : 37735,UCB153

Unit No.
FORD : E8NN-10316
LUCAS : 24246A,24256AC, 24258A,24262A,24273...



VR-LC115
 *Voltage Set Point: 14.4V

Replaces
LUCAS : 35381720

Unit No.
LUCAS : 35213795,35213940, 35213995,35214100



VR-LC200
 *Voltage Set Point:14.5V

Replaces
BL/JAGUAR : AEU1526,AEU1669,AEU1915,AEU2750, AEU4007A...
FORD : 1591687,81DB-10316CA
LUCAS : 37624,37636,37640,37659,37661,37666,37667...
MAGNETI MARELLI : 940038132
MASSEY FERGUSON : 1897266M1,1897294M1,3473155M1...
MOTORCRAFT : EGR311,EGR313

Unit No.
LUCAS : 23970,23971,23996,24011,24029,24030...

Replaces
BL/JAGUAR : AEU1526,AEU1669,AEU1915,AEU2750, AEU4007A...
FORD : 1591687,81DB-10316CA
LUCAS : 37624,37636,37640,37659,37661,37666,37667...
MAGNETI MARELLI : 940038132
MASSEY FERGUSON : 1897266M1,1897294M1,3473155M1...
MOTORCRAFT : EGR311,EGR313

Unit No.
LUCAS : 23970,23971,23996,24011,24029,24030...

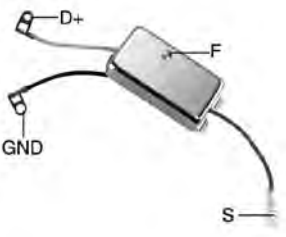

VR-LC201
 *Voltage Set Point:14.5V

Replaces
LUCAS : 37621,37659,37684,UCB126
MOTORCRAFT : EGR314

Unit No.
LUCAS : 23996,24049,24096,24115

Replaces
LUCAS : 37621,37659,37684,UCB126
MOTORCRAFT : EGR314

Unit No.
LUCAS : 23996,24049,24096,24115

Replaces
LUCAS : 37621,37659,37684,UCB126
MOTORCRAFT : EGR314

Unit No.
LUCAS : 23996,24049,24096,24115

Replaces
LUCAS : 37621,37659,37684,UCB126
MOTORCRAFT : EGR314

Unit No.
LUCAS : 23996,24049,24096,24115

Replaces
LUCAS : 37621,37659,37684,UCB126
MOTORCRAFT : EGR314

Unit No.
LUCAS : 23996,24049,24096,24115

Replaces
LUCAS : 37621,37659,37684,UCB126
MOTORCRAFT : EGR314

Unit No.
LUCAS : 23996,24049,24096,24115

Replaces
LUCAS : 37621,37659,37684,UCB126
MOTORCRAFT : EGR314

Unit No.
LUCAS : 23996,24049,24096,24115

Replaces
LUCAS : 37621,37659,37684,UCB126
MOTORCRAFT : EGR314

Unit No.
LUCAS : 23996,24049,24096,24115

- Brush Holder
- Voltage Regulator
- Repair Circuit
- Rectifier
- Diode Trio
- Diode
- Tester

**VR-F110A**

*Voltage Set Point:14.7V

Replaces

BOSCH : 9-190-110-032,9-190-333-707
ELMOT : RC212B,RC212D,RC212E
FEMSA : GRO12-3Y,GRO12-X1Y,GRO12-X30,RFH12-11,RFH12-7
FIAT : 4074763,4095889,4095898,4191122,4202969...
ISKRA : 11-125-110,AER3007
LADA : 21013702000
MAGNETI MARELLI : 63408004,63408005,63408007...
VALEO : 505050,505051,505053
VALEO(MOTOROLA) : 9RH7021,9RH7029,9RH7044

**VR-F110B***24V
*Voltage Set Point:28.3V**Replaces**

BOSCH : 9-190-333-704
ELMOT : RC128,RC224
FEMSA : RFH24-4
FIAT : 4087071,4112453,4205243,4215948,4288170...
ISKRA : 11-125-091,AER3001
LUCAS : 2193008,NCB811
MAGNETI MARELLI : 63408305,63408306,64808102...
VALEO : 505054
VALEO(MOTOROLA) : 9RH8043

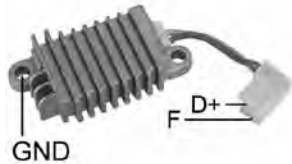
**VR-F114A***A-Circuit
*Inactive Lamp
*Voltage Set Point:14.5V**Replaces**

BOSCH : 0-986-192-005
FIAT : 4475112,4721593
LUCAS : 21222081,21222106,21932004,UCB802,UCB805
MAGNETI MARELLI : 64808106,64808140,64808143,RTT114A

Unit No.

FIAT : 4393206,4395131,5920974
MAGNETI MARELLI : 62307526,63305206,63305400,63305401...

**VR-F114B***24V
*Voltage Set Point:28.3V**Replaces**

FIAT : 9959694,9983355
LUCAS : 21222119,UCB807
MAGNETI MARELLI : 64808141,81200270,RTT114B

Unit No.

FIAT : 4715786,4738563
MAGNETI MARELLI : 63306000,63306300,AA125-28-30A

**VR-F118**

*Voltage Set Point:14.6V

Replaces

MAGNETI MARELLI : 64808182,64808184,64808241...

Unit No.

MAGNETI MARELLI : 63320027,63320039,63320041,63321057...

**VR-F119**

*Voltage Set Point:14.7V

Replaces

DELCO REMY (LUCAS) : 21222127
FIAT : 9939826,9941193
ISKRA : 11125097
LUCAS : 21222127,UCB808,2122121,581200220000...
MAGNETI MARELLI : 58120022,79707161,79707481...
VALEO(DUCELLIER) : 592967

Unit No.

MAGNETI MARELLI : 633-200SERIES,633-210SERIES

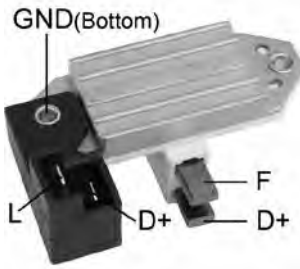

VR-F119B
 *24V
 *Voltage Set Point:28.3V

Replaces
 FIAT : 8190407
 LUCAS : 21222126,UCB806
 MAGNETI MARELLI : 79707441,RTT119B
 VALEO(DUCELLIER) : 592968
Unit No.
 MAGNETI MARELLI : 63320025,63320052,63320057,63320118...



VR-F121
 *Soft Start
 *2.5 sec. LRC
 *Short Circuit Protection
 *Voltage Set Point:14.7V
Replaces
 MAGNETI MARELLI : 28018A
Unit No.
 MAGNETI MARELLI : 54022459,
 54022469,54022470,54022606...



VR-F121T
 *Soft Start
 *2.5 sec. LRC
 *Short Circuit Protection
 *Voltage Set Point:14.7V
Replaces
 FIAT : 9946618,9950586
 MAGNETI MARELLI :
 24TR,24TR/B,54209305,
 83614251...
Unit No.
 MAGNETI MARELLI : A1271



VR-F150A
 *W/Capacitor
 *W/Choke
 *Voltage Set Point:14.7V
Replaces
 MAGNETI MARELLI :
 83615921,RTM150B
Unit No.
 MAGNETI MARELLI :
 63321261,63341261,A1271M

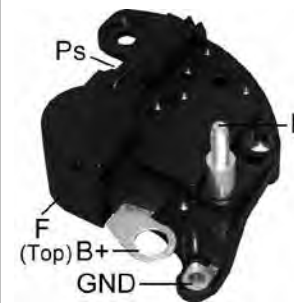

VR-F151A
 *W/Capacitor
 *W/Choke
 *Voltage Set Point:14.4V
Replaces
 FIAT : 9946542
 MAGNETI MARELLI :
 83611361,RTM121A,RTM151A,
 RTM151B...
Unit No.
 MAGNETI MARELLI : 63320200,
 63320203,63320219,63320227...



VR-F153A
 *W/Capacitor
 *W/Choke
 *Voltage Set Point:14.7V
Replaces
 MAGNETI MARELLI :
 83617181,RTM153B
Unit No.
 LANDROVER : 63321240
 MAGNETI MARELLI : 63321321,
 63321333,63321351,63321352...



VR-F153MB
 *24V
 *Voltage Set Point:28.3V
Unit No.
 MAGNETI MARELLI : 54022667



VR-F154
 *w/battery sensor
 *Voltage Set Point:12.6V
Replaces
 MAGNETI MARELLI : 54209276
Unit No.
 MAGNETI MARELLI : 54022443



VR-F154B
 *24V
 *Short Circuit Protection
 *Voltage Set Point: 28.5V
Unit No.
 DENSO : 102211-8140,
 102211-8150
 MAGNETI MARELLI :
 63377465,63377466

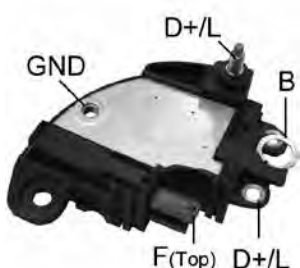

VR-F155
 *Voltage Set Point:14.4V

Replaces
 MAGNETI MARELLI : 85562061,85563501
Unit No.
 MAGNETI MARELLI : 63321671,63321641,63341641,63341671

Brush Holder

Voltage Regulator

Repair Circuit

Rectifier

Diode Trio

Diode

Tester

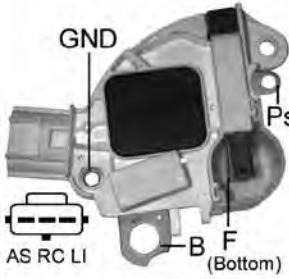

VR-F156

- *Voltage Set Point:14.0V
- *Regulated Voltage Control(RVC)
- *Requires RVC01 tester box for testing

Replaces

LUCAS : 83627781010,85562541010
 MAGNETI MARELLI : 085582601010,85562541,85562801...

Unit No.

FORD : 98AB10300GD
 MAGNETI MARELLI : 63321678,63321679,63321746,63341679
 VALEO(PARIS RHONE) : A1151

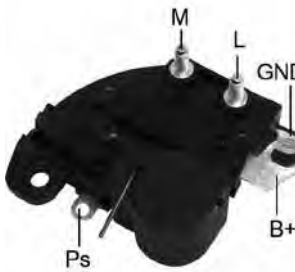

VR-F157

- *Voltage Set Point:14.4V
- *Self Exciting
- *Soft Start
- *W/Short Circuit Protection

Replaces

MAGNETI MARELLI : 85563491,RTM300.01

Unit No.

MAGNETI MARELLI : 63321733, 63321734,63321740,63321741...

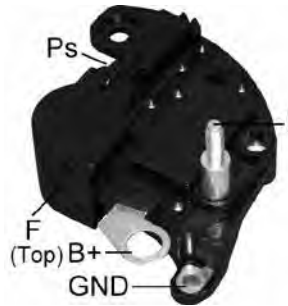

VR-F158

- *Voltage Set Point:14.4V
- *Soft Start
- *W/Short Circuit Protection

Replaces

MAGNETI MARELLI : 85562881,85562731,85562991

Unit No.

MAGNETI MARELLI : A127IM,63321491,63321494, 63321507...



VR-F159

- *Voltage Set Point:14.4V
- *Soft Start
- *W/Short Circuit Protection

Replaces

MAGNETI MARELLI : 85552506

Unit No.

DENSO : 102211-8611,102211-8660
 FIAT : 46835095,51784846
 MAGNETI MARELLI : RTM200.13



VR-F160



- *Soft Start
- *2.5 sec. LRC
- *Short Circuit Protection
- *PHIN : Activated terminal
- *Self Exciting
- *Voltage Set Point:14.4V

Replaces

MAGNETI MARELLI : 85563481,RTM200.03,RTM200.09

Unit No.

MAGNETI MARELLI : 63321702,63321658,63320545,63320535...

 <p>VR-MP134 *Voltage Set Point:14.5V</p> <p>Replaces MAGNETON-PAL : 443930134291,443930136111...</p> <p>Unit No. MAGNETON-PAL : 44311351663 0,443113516631,443113516632...</p>	 <p>VR-MP419 *Voltage Set Point:14.5V</p> <p>Replaces MAGNETON-PAL : 443116419070,443116419071 SKODA : 907040114</p>

- Brush Holder
- Voltage Regulator
- Repair Circuit
- Rectifier
- Diode Trio
- Diode
- Tester

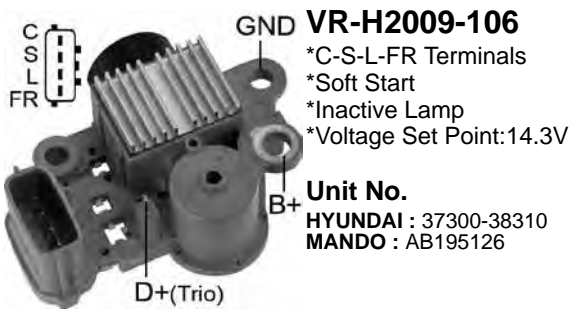
**VR-H2009-106**

*C-S-L-FR Terminals
 *Soft Start
 *Inactive Lamp
 *Voltage Set Point:14.3V

Unit No.

HYUNDAI : 37300-38310
 MANDO : AB195126

**VR-H2009-86**

*L-S Terminals
 *Voltage Set Point:14.2V

Replaces

KIA : 37370-22200
 VALEO : TA500C02401
Unit No.
 HYUNDAI : 37300-22200

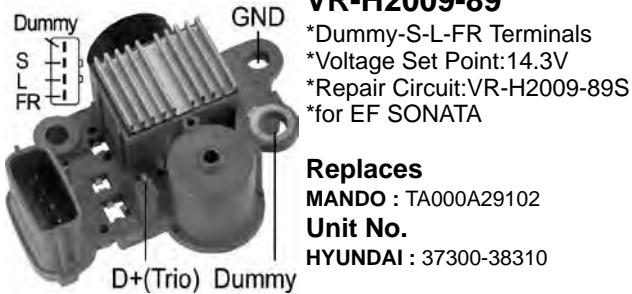
**VR-H2009-89**

*Dummy-S-L-FR Terminals
 *Voltage Set Point:14.3V
 *Repair Circuit:VR-H2009-89S
 *for EF SONATA

Replaces

MANDO : TA000A29102
Unit No.
 HYUNDAI : 37300-38310

**VR-MD01**

*Voltage Set Point:14.2V

Replaces

KIA : 37370-42000,37370-42540
 MANDO : 37300-42010,37300-42502,37300-42750
 VALEO : 139669
Unit No.
 HYUNDAI : 37300-42204

**VR-MD03**

*Adjustable Voltage
 *Black: B-
 *Green:D+
 *Red: Sense
 *Blue: Ignition
 *Orange: Field

Replaces

MANDO : 12449,42786
Unit No.
 MANDO : AR150BA,AR150CA

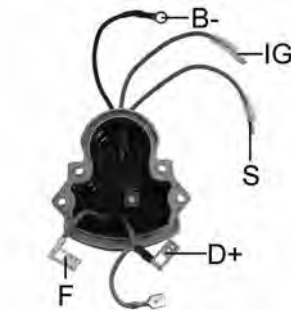
**VR-MD04**

*Adjustable Voltage
 *Black: B-
 *Green:D+
 *Red: Sense
 *Blue: Ignition
 *Orange: Fiel

Replaces

MANDO : 3ER1071,42785
 VALEO : 3ER1071,42785
Unit No.
 MANDO : AR150A,AR150AA,AR150AC

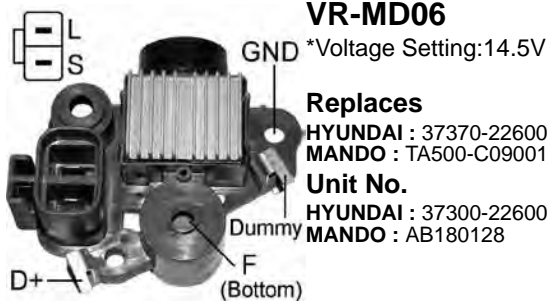
**VR-MD06**

*Voltage Setting:14.5V

Replaces

HYUNDAI : 37370-22600
 MANDO : TA500-C09001
Unit No.
 HYUNDAI : 37300-22600
 MANDO : AB180128

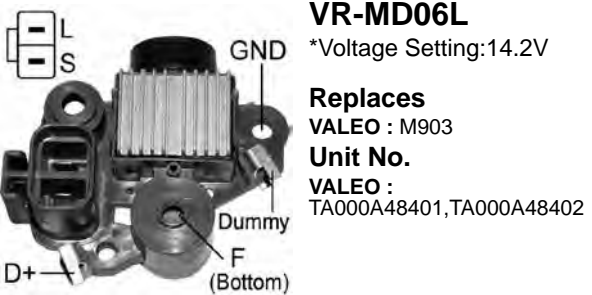
**VR-MD06L**

*Voltage Setting:14.2V

Replaces

VALEO : M903
Unit No.
 VALEO : TA000A48401,TA000A48402

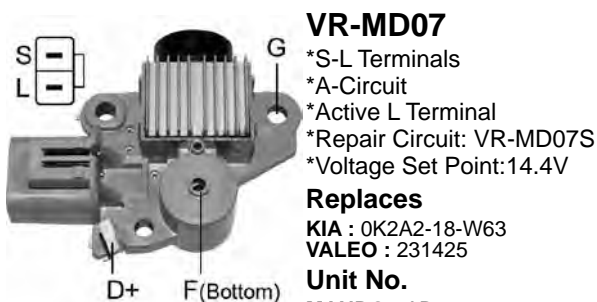
**VR-MD07**

*S-L Terminals
 *A-Circuit
 *Active L Terminal
 *Repair Circuit: VR-MD07S
 *Voltage Set Point:14.4V

Replaces

KIA : 0K2A2-18-W63
 VALEO : 231425
Unit No.
 MANDO : AB170094

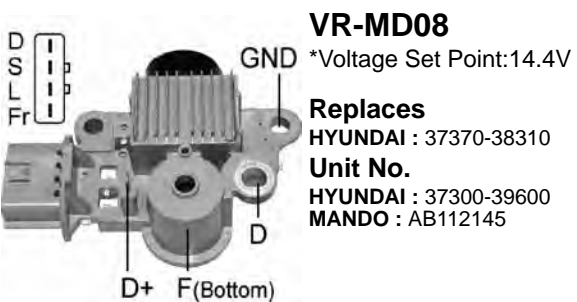
**VR-MD08**

*Voltage Set Point:14.4V

Replaces

HYUNDAI : 37370-38310
Unit No.
 HYUNDAI : 37300-39600
 MANDO : AB112145

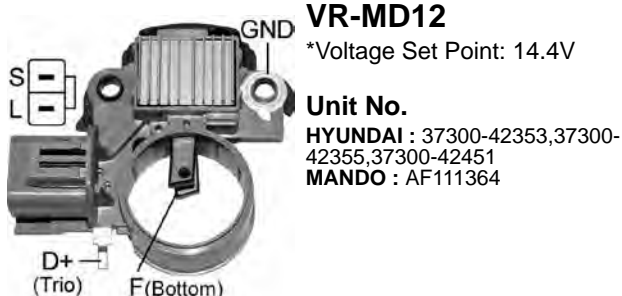
**VR-MD12**

*Voltage Set Point: 14.4V

Unit No.

HYUNDAI : 37300-42353,37300-42355,37300-42451
 MANDO : AF111364

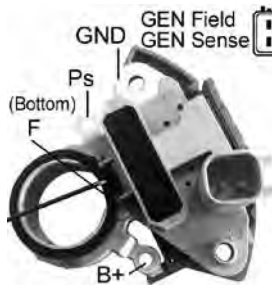

TB-M001

*Terminal Block

Unit No.

CHRYSLER :
04801490AA,4801490AA
MITSUBISHI :
A2TX0281,A2TX0281ZC



TB-M146

*Terminal Block

Unit No.

MITSUBISHI : A2TJ0481,
A2TJ0481ZC,A002TJ0481ZC...

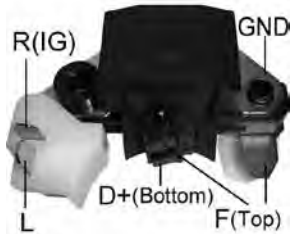

VR-H2009

*A-Circuit
*R-L Terminals
*Voltage Set Point:14.7V

Replaces

BOSCH : 0-986-192-016
FORD : E27Z-10316A
LUCAS : 21513103,UCJ200
MAGNETI MARELLI : 940038076
MAZDA : 8173-18-300,8173-24-520,N221-24-520
MITSUBISHI : A866T00470,A866T00670,A866T01970...
MITSUBISHI MOTORS : MD607372,MD607570
Unit No.
MAZDA : 1480-18-300,8173-18-300,8173-18-300B...
MITSUBISHI : A1T23377,A1T25191,A1T31371,A1T31699...
MITSUBISHI MOTORS : MD006187,MD007509,MD009052,
MD00905



VR-H2009-1

*24V
*Voltage Set Point:28.3V

Replaces

MITSUBISHI : 3Y6693,R008T10471,R008T10472

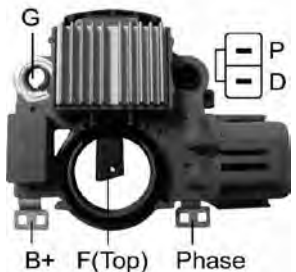

VR-H2009-100

* P-D Terminals
* Short Circuit Protection
***Traditional test method will immediately damage P-D regulator. Avoid damage using Mobiletron VR-H2009-66TF test fixture.

Replaces

MAZDA : GY01-18-W70
MITSUBISHI : 465,A866X46572,444

Unit No.

MAZDA : GY01-18-300E,GY01-18-300R
MITSUBISHI : A3TB1081,A3TB1081A



VR-H2009-102

*AS-RC-LI Terminals
*Voltage Set Point:14.0V
*Regulated Voltage Control(RVC)
*Used on Ford Mondeo and Escape 2.0
*Requires RVC01 tester box for testing

Replaces

MITSUBISHI : A866X50372,503
Unit No.
FORD : 2S6T-10300DB,2S6U-10300GB
MITSUBISHI : A5TA7792,A003TG5591ZC

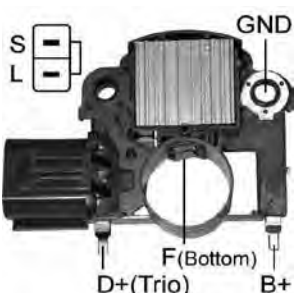

VR-H2009-103

*S-L Terminals
*Repair Circuit:VR-H2009-11S
*Voltage Set Point:14.6V
*w/o Drive Choke

Replaces

MITSUBISHI : 145,A866X14570,A866X14572
Unit No.
MITSUBISHI : A005T03092,A005T03192,A5T00192

Brush Holder

Voltage Regulator

Repair Circuit

Rectifier

Diode Trio

Diode

Tester

**VR-H2009-105**

- * L-DFM Terminals
- * Soft Start
- * 3.5 sec LRC
- * L Terminal Drive Choke
- * Repair Circuit:VR-H2009-105S
- * Voltage Set Point:14.5V

Replaces

MITSUBISHI : A866X49872,498

Unit No.

CITROEN : 9638275880

MITSUBISHI : A5TA6291,A1TA3391,A1TA3392C,A5TA6291...

Brush Holder

Voltage Regulator

Repair Circuit

Rectifier

Diode Trio

Diode

Tester

**VR-H2009-105SE**

- * L-DFM Terminals
- * Soft Start
- * 2.5 sec LRC
- * Self Exciting
- * L Terminal Does Not Drive Choke
- * Voltage Set Point:14.5V

Replaces

MITSUBISHI : 506

Unit No.

CITROEN : 9640088080

MITSUBISHI : A5TA6391,A5TA6292G,A5TA6391A,A5TA6391B...

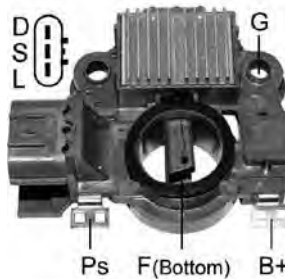
**VR-H2009-107**

- * D-S-L Terminals
- * Voltage Set Point:14.4V

Replaces

SUBARU : 23815-AA150,23815-AA140

Unit No.

MITSUBISHI : A3TG2391,A2TB6291,A002TB2891...

SUBARU : 23700-AA430,23700-AA55A

**VR-H2009-108**

- * S-L Terminals
- * Soft Start
- * Short Circuit Protection
- * Repair Circuit:VR-H2009-115S
- * Voltage Set Point:14.5V

Unit No.

FORD : XF52-10300AC,XF5Z-10346AA

MITSUBISHI : A3TA5691

NISSAN : 23100-7B000

**VR-H2009-109**

- * C-S-L Terminals
- * Voltage Set Point:14.5V
- * Soft Start
- * Short Circuit Protection

Replaces

MITSUBISHI : A3TB1891,A866X47272

SUBARU : 23815-AA160

Unit No.

MITSUBISHI : A2TB3091,A2TB5391,A3TB1891

SUBARU : 23700-AA380,23700-AA420

**VR-H2009-10A**

- * I-S(D)-A Terminals
- * Repair Circuit:VR-H2009-10AS
- * Voltage Set Point:14.6V

Replaces

FORD : E8PZ-10316B,GRE793

MITSUBISHI : A866X13970,A866X13971

Unit No.

FORD : E83F-10300AA,E83F-10300AB,E83F-10300BA...

MITSUBISHI : A3T01596MA,A3T01598MA,A3T01598NA



VR-H2009-110

- *C-IG-L-FR Terminals
- *Soft Start
- *Short Circuit Protection
- *Voltage Set Point:14.5V

Replaces

MITSUBISHI : A866X44472,590

Unit No.

MITSUBISHI : A1TA1891,A1TA1891A,A1TA1991,A1TA2491...

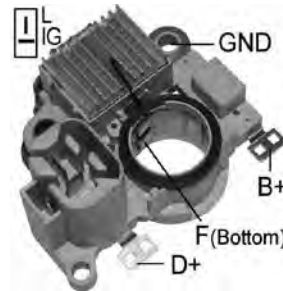

VR-H2009-111

- *L-IG Terminals
- *w/ capacitor
- *Voltage Set Point:14.7V

Replaces

MITSUBISHI : A866X35972,359

Unit No.

SUZUKI : 31400-73G11



VR-H2009-112

- * L-Dummy Terminals
- * Soft Start
- * 4.5 sec. LRC
- * Inactive Lamp
- * Short Circuit Protection
- * Repair Circuit: VR-H2009-112S
- * Voltage Set Point:14.5V

Replaces

MITSUBISHI : 491

Unit No.

MITSUBISHI : A2TB6481,A2TC0981,A2TC0982,A1TA2291...

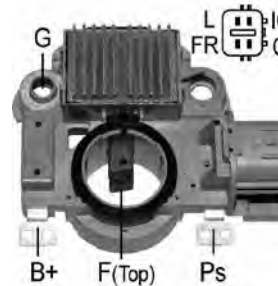

VR-H2009-113

- *IG-C-L-FR Terminals
- *Inactive Lamp
- *Soft Start
- *4 sec LRC
- *Short Circuit Protection
- *Voltage Set Point:14.5V

Replaces

HONDA : 31150-RNA-A01

MITSUBISHI : A866X55852,558

Unit No.

HONDA : 31100-RNE-A01,31100-RNE-A010M2,AHGA75

MITSUBISHI : A2TC1391,A2TC1391ZC,A002TC1591...

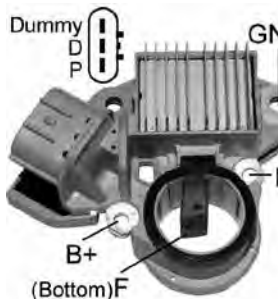

VR-H2009-114

- *Inactive Lamp
- *W/Capacitor 2.2uF
- *Works with PCM
- **Traditional test method will immediately damage P-D regulator. Avoid damage using Mobiletron VR-H2009-66TF test fixture.

Replaces

MITSUBISHI : A866X50572,505

Unit No.

MAZDA : AJ51-18-300,AJ57-18-300A,AJ51-18-W70...

MITSUBISHI : A2TJ0391,A3TJ0191,A3TJ0291,A3TJ1191...

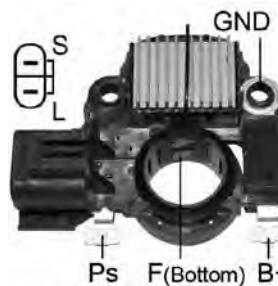

VR-H2009-115

- * S-L Terminals
- * Inactive Lamp
- * Short Circuit Protection
- * S Open Lamp On
- * Voltage Set Point:14.5V

Replaces

MITSUBISHI : 350,626,A866X35072,341,435,A866X34272

SUBARU : 23815-AA090

Unit No.

GM : 92058857

MITSUBISHI : A2TA7691,A2TA7591

NISSAN : 23100-0Y710,23100-65F17

SUBARU : 23700-AA280

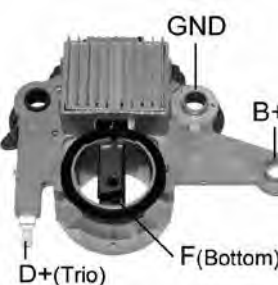

VR-H2009-117

- *Voltage Set Point: 14.5V

Replaces

JDWP : JFZ1913

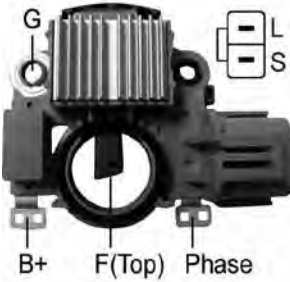
**VR-H2009-118**

- *S-L Terminals
- *Short Circuit Protection
- *S Open Lamp On
- *Voltage Set Point:14.5V

Replaces

MITSUBISHI : A866X36272,A866X42972,429
NISSAN : 23215-0M011

Unit No.

MITSUBISHI : A2T33593B,A2TB0491,A2TB3891
NISSAN : 23100-0M010,23100-6T012,23100-4M610...

**VR-H2009-119**

- *C-FR-IG-L Terminals
- *Inactive Lamp
- *Soft Start
- *4 sec. LRC
- *Short Circuit Protection
- *Voltage Set Point:14.5V

Unit No.

HONDA : 31100-RSH-004
MITSUBISHI : A5TB1391

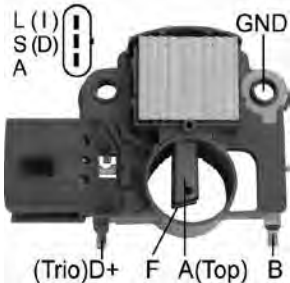
**VR-H2009-11H**

- *I-S(L/IG)-A Terminals
- *Repair Circuit:VR-H2009-11S
- *Voltage Set Point:14.6V

Replaces

FORD : E8PZ-10313A,E8PZ-10316A,GRE792
MITSUBISHI : A866X14072
MOTORCRAFT : GRE317

Unit No.

FORD : E8SF-10300AA,E8SZ-10346A
MITSUBISHI : A3T01496,A3T01496MA
MOTORCRAFT : GLE-254

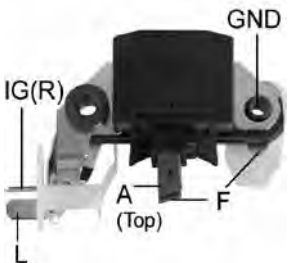
**VR-H2009-12**

- *24V
- *R-L Terminals
- *Voltage Set Point:28.3V

Replaces

MITSUBISHI : A866T06670
MITSUBISHI MOTORS : ME700571

Unit No.

MITSUBISHI : A5T70178,A5T70183,A5T70283,A5T70383
MITSUBISHI MOTORS : ME007578,ME017560,
 ME017561,ME04916

**VR-H2009-120**

- *A-Circuit
- *Inactive Lamp
- *Short Circuit Protection
- *S Open Lamp On
- *Voltage Set Point:14.5V

Replaces

MITSUBISHI : A866X39183,A866X47172,A866X39172,391

Unit No.

MITSUBISHI : A7TA3377,A3T09678A,A3T09698A,A3T09798A...
NISSAN : 23100-FU410

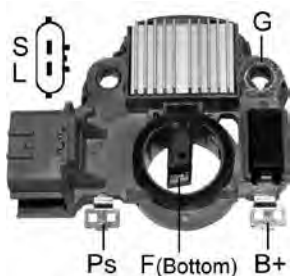
**VR-H2009-121**

- *Soft Start
- *Short Circuit Protection
- *Voltage Set Point: 14.4V

Unit No.

NISSAN : 23100-2Y005

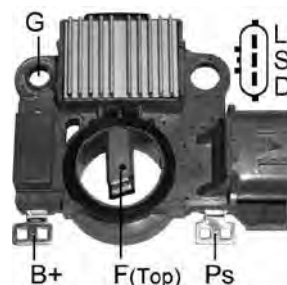
**VR-H2009-122**







- *Soft Start
- *5 sec. LRC
- *Short Circuit Protection
- *Voltage Set Point: 14.4V

Replaces

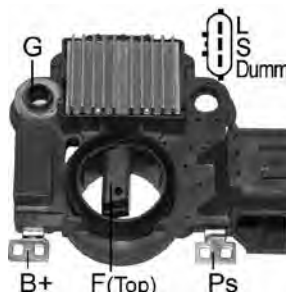
MITSUBISHI : A866X56672,566

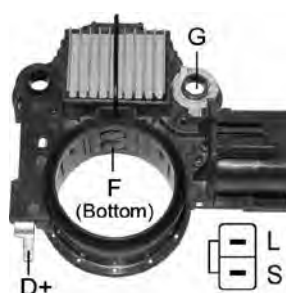
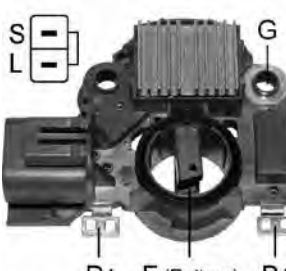
Unit No.

MITSUBISHI : A3TG2681AE,
 A2TG1581,A2TG1581AC
NISSAN : 23100-EB31A,
 23100-ZW40B

 <p>VR-H2009-123 *Short Circuit Protection *Voltage Set Point: 14.5V Unit No. MITSUBISHI : A2TG-1081ZT NISSAN : 23100-EB71A</p>	 <p>VR-H2009-125B *24V *Voltage Set Point:28.3V Replaces MITSUBISHI : 576 Unit No. MITSUBISHI : A004TA8191,A4TA8191,A004TA8591,A4TA8591</p>
 <p>VR-H2009-126 *Inactive Lamp *Dummy-D-P Terminals *Voltage Set Point:14V *Work with PCM *** Traditional test method will immediately damage P-D regulator. Avoid damage using Mobiletron VR-H2009-66TF test fixture.</p>	<p>Replaces MITSUBISHI : 561 Unit No. MAZDA : ZJ38-18-300 MITSUBISHI : A2TG1391,A002TG1391,A3TG5691,A3TB6581...</p>
 <p>VR-H2009-128 *L-S Terminals *Voltage Set Point: 14.5V</p>	<p>Replaces HYUNDAI : 37370-42300 VALEO : 235551 Unit No. HYUNDAI : 37300-4A001,37300-4A002,37300-4A003... MANDO : AF111225,AF111382,AF111390,AF111393... VALEO : TA000A48201,TA000A54701,TA000A56901...</p>
 <p>VR-H2009-129 *S-L Terminals *Voltage Set Point: 14.5V</p>	<p>Replaces MAZDA : B307-18-W70,B3C7-18-W70,JE48-18-W70 MITSUBISHI : A866X38072,A866X24072,A866X20572... Unit No. MITSUBISHI : A3TA2391A,A3TA2391 MITSUBISHI MOTORS : MD313384,MD318460,MD354804</p>
 <p>VR-H2009-130 *Soft Start *5 sec LRC *W/Capacitor 2.2uF *Short Circuit Protection *Voltage Set Point:14.5V *Regulated Voltage Control(RVC) *Requires RVC01 tester box for testing</p>	<p>Replaces MITSUBISHI : A866X68272,A866X54779,A866X54762,682,547 Unit No. MITSUBISHI : A3TJ0691,A3TJ0781,A2TJ0581,A3TJ1791... NISSAN : 23100-EG010,23100-EB315,23100-1FC1A...</p>
 <p>VR-H2009-132B *24V *S Open Lamp On *Voltage Set Point: 28.3V Replaces MITSUBISHI : 553 Unit No. MITSUBISHI : A4TR5894ZT,A4TR5591ZT,A004TR6491AT...</p>	 <p>VR-H2009-132BA *24V *S Open Lamp On *Voltage Set Point: 28.3V *w/plastic cover, insulated plate, protect cover for welding Replaces MITSUBISHI : 553 Unit No. MITSUBISHI : A4TR5894ZT,A4TR5391</p>

Brush Holder

Voltage Regulator

Repair Circuit

Rectifier

Diode Trio

Diode

Tester

**VR-H2009-135B**

- *24V
- *L-IG-S Terminals
- *Voltage Set Point:28.3V

Unit No.

MITSUBISHI : A4TA0591,A4TA0592,A4TA0594,A4TA8291...

**VR-H2009-139**

- *C-FR-IG-L Terminals
- *Soft Start
- *7 sec. LRC
- *W/Capacitor 2.2uF
- *Voltage Set Point:14.5V

Replaces

HONDA : 31150-RB0-004
MITSUBISHI : 605

Unit No.

HONDA : 31100-RB0-004,31100-RB0-0041...
MITSUBISHI : A5TJ0091

**VR-H2009-140**

- *Voltage Set Point: 14.0V
- *Regulated Voltage Control(RVC)
- *Requires RVC01 tester box for testing

Replaces

FORD : BL1T-10300BB,BL1Z-10346A
MITSUBISHI : 622,A3TX0692

Unit No.

FORD : 8S4T-10300AA,8S4Z-10346A,8A4T-10300AC...
MITSUBISHI : A2TX0191,A3TX0091,A003TX0091...

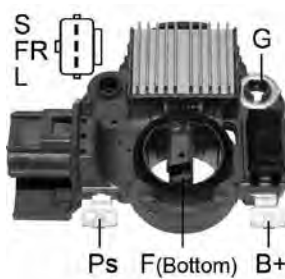
**VR-H2009-141**

- *S-FR-L Terminals
- *Soft Start
- *6 sec. LRC
- *Short Circuit Protection
- *Voltage Set Point: 14.5V

Replaces

MITSUBISHI : A866T30070,300

Unit No.

MITSUBISHI : A4A3R30062

**VR-H2009-144**

- *Soft Start
- *5 sec. LRC
- *Short Circuit Protection
- *Voltage Set Point: 14.5V

Replaces

HONDA : 31150-REA-Z01
MITSUBISHI : 513

Unit No.

HONDA : 31100-REA-Z01,
AHGA58
MITSUBISHI : A5TB0291ZD

**VR-H2009-145**

- *C-S-L Terminals
- *Voltage Set Point:14.5V
- *Soft Start
- *5 sec. LRC
- *Short Circuit Protection
- *Regulated Voltage Control (RVC)
- *Requires RVC01 tester box for testing

Replaces

MITSUBISHI : A866X54472,547,544

Unit No.

MITSUBISHI : A3TG2681ZE,A3TG5381RL,A003TG5381RL
NISSAN : 23100-EB310

**VR-H2009-147**

- *Soft Start
- *8 sec. LRC
- *Short Circuit Protection
- *Voltage Set Point:14.6V

Replaces

MITSUBISHI : 548
SUZUKI : 32500-61J00

Unit No.

SUZUKI : 31400-61J00

**VR-H2009-148**

*Soft Start
 *5 sec LRC
 *W/Capacitor 0.5uF
 *Short Circuit Protection
 *Voltage Set Point:14.5V

Replaces

MITSUBISHI : 564

Unit No.

MITSUBISHI : A2TJ0281,A2TJ0281ZC,A2TJ0291,A2TJ0291ZC...
NISSAN : 23100-EM01A,23100-EM01B,23100-EM01BR...

**VR-H2009-14N**

*D-IG-L Terminals
 *Repair Circuit:
 VR-H2009-14NS
 *Voltage Set Point:14.6V
 *w/o Drive Choke

Replaces

MITSUBISHI : A866X11870

SUZUKI : 32500-60A10

Unit No.

MITSUBISHI : A1T03191,A1T03195
SUZUKI : 31400-60A20

**VR-H2009-15**

*I-A Terminals
 *Repair Circuit:VR-H2009-15S
 *Voltage Set Point:14.5V

Replaces

FORD : E9PZ10316AA

MITSUBISHI : A866X13272,A866X15170,A866X17470...

NISSAN : 23215-35F10,23215-64J11,23215-64J12

Unit No.

FORD : E9DF-10300BB, E9PZ-10316A

MITSUBISHI : A2T02394,A2T05192,A2T13894,A2T14694...

MOTORCRAFT : GLE-261,GRE-796

NISSAN : 23100-12C10,23100-15P11,23100-31P10...

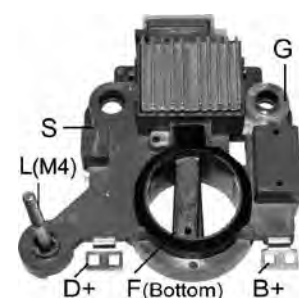
**VR-H2009-151B**

*24V
 *Voltage Set Point: 28.7V

Unit No.

MITSUBISHI : A4TR5191,A4TR5188,A4TR5191ZT,A4TR5191
SCANIA : 1516176,1525447

**VR-H2009-152**

*C-FR-IG-L Terminals
 *Soft Start
 *Short Circuit Protection
 *Voltage Set Point: 14.5V

Replaces

MITSUBISHI : 438

Unit No.

HONDA : 31100-PEJ-004,AHGA35
MITSUBISHI : A5TA4591,A5TA3591

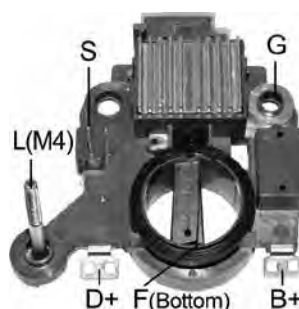
**VR-H2009-153**

*Voltage Set Point: 14.3V

Replaces

MITSUBISHI : 518

Unit No.

MITSUBISHI : A3TR0091,A3TR0093,A3TR0094,A3TR0091ZT...

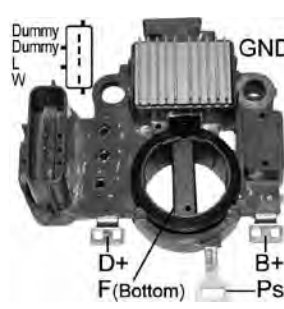
**VR-H2009-154B**

*24V
 *Voltage Set Point: 28.5V

Replaces

MITSUBISHI : 514

Unit No.

MITSUBISHI : A4TR5091ZT,A4TR5091
RENAULT : 5001866377,5010480765

**VR-H2009-157**

*Voltage Set Point: 14.5V

Unit No.

HYUNDAI : 37011-00J11-A1

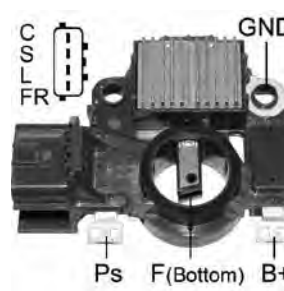
**VR-H2009-159**

*Soft Start
 *S Open Lamp On
 *Voltage Set Point: 14.5V

Replaces

MITSUBISHI : 557,428

Unit No.

MITSUBISHI : A3TG3181, A3TB5291,A3TG4679,A3TG3791

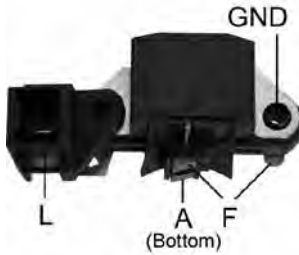
**VR-H2009-16**

*L Terminal
*Voltage Set Point:14.7V

Replaces

DELCO REMY (LUCAS) : 21513127
MITSUBISHI : A866T03870,A866T05670,A866T13370

Unit No.

MITSUBISHI : A2T26391,A2T27091,A3T03291,A3T03292...

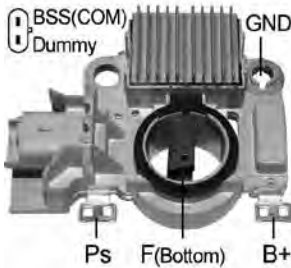
**VR-H2009-160**

*BSS 3 Connections
*Requires COM01 test adaptor for testing
*ID Code: 167

Replaces

MITSUBISHI : 574

Unit No.

MITSUBISHI : A5TG0192B,A5TG1392B,A5TG1392,A5TG1392A
PEUGEOT : 9660055080,9666030280,5705.EG,5705.KW

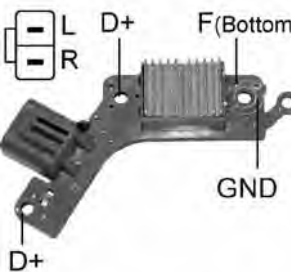
**VR-H2009-161**

*L-R Terminals
*Voltage Set Point: 14.5V

Replaces

MITSUBISHI : A866X28672

Unit No.

MITSUBISHI : A4TU0088

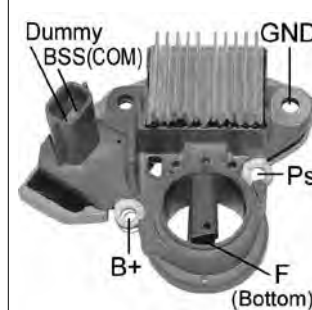
**VR-H2009-164**

*BSS 3 connections
*Requires COM01 test adaptor for testing
*ID Code: 179

Replaces

MITSUBISHI : 551

Unit No.

MITSUBISHI : A004TJ0282,A004 T J0282ZE,A4TJ0282...
RENAULT : 8200654785,820096 0536,8200654786...

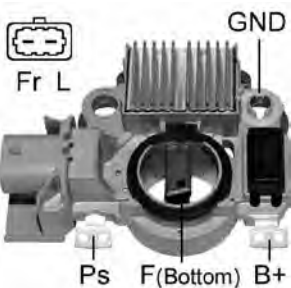
**VR-H2009-168**

*Soft Start
*5 sec LRC
*Short Circuit Protection
*Voltage Set Point:14.5V

Replaces

MITSUBISHI : 533

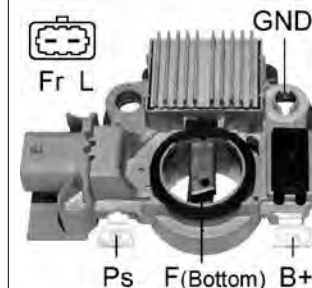
**VR-H2009-169**

*Fr-L Terminals
*Soft Start
*2.5 sec LRC
*Voltage Set Point:14.5V

Unit No.

MITSUBISHI : A003TG1581, A3TG1581,A3TG1991

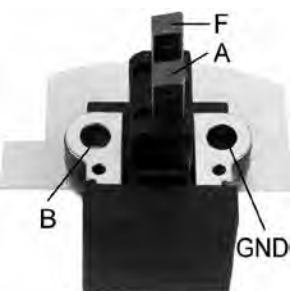
**VR-H2009-17**

*24V
*Voltage Set Point:28.3V

Replaces

MITSUBISHI : A866T01070,A866X01070
MITSUBISHI MOTORS : ME700091

Unit No.

MITSUBISHI : A2T61571,A2T61871,A2T61971,A2T70571...
MITSUBISHI MOTORS : ME007396,ME007397,ME007533, ME00754

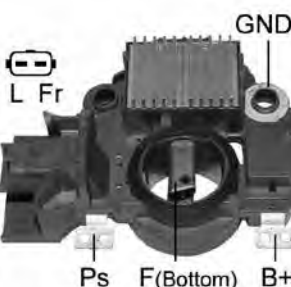
**VR-H2009-170**

*L-Fr Terminals
*Soft Start
*3.5 sec LRC
*Short Circuit Protection
*Self Exciting
*Voltage Set Point:14.5V

Replaces

MITSUBISHI : 606

Unit No.

CITROEN : 9642124980
MITSUBISHI : A3TB2691,A003TB2691K,A3TB2691K...

**VR-H2009-171**

- * Voltage Set Point: 14.5V
- * LIN-2
- * 2400-19200 Baud Rate (4 Byte)
- * Requires COM01 test adaptor for testing

Replaces

HONDA : 31150-R1A-A01
MITSUBISHI : 667

Unit No.

HONDA : 31100-R1A-A01
MITSUBISHI : A005TJ0191,A5TJ0191,A5TJ0191ZC...

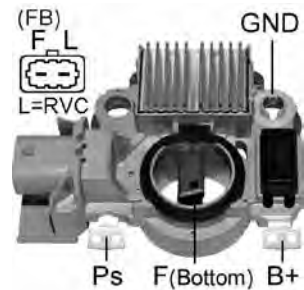
**VR-H2009-172**

- *Soft Start
- *4 sec. LRC
- *Short Circuit Protection
- *Voltage Set Point: 13.8V
- *Regulated Voltage Control(RVC)
- *Requires RVC01 tester box for testing

Replaces

MITSUBISHI : 598

Unit No.

GM : 92191127
MITSUBISHI : A3TG4091,A3TG4191,A3TG1591,A3TG1491...

**VR-H2009-173**

- *Soft Start
- *5 sec LRC
- *Short Circuit Protection
- *Voltage Set Point: 14.5V
- *Regulated Voltage Control(RVC)
- *Requires RVC01 tester box for testing

Replaces

MITSUBISHI : 660,661

Unit No.

MITSUBISHI : A2TX0881,A2TX0881A,A2TX1081

**VR-H2009-175**

- *Voltage Set Point: 14.5V

Replaces

MITSUBISHI : 542

Unit No.

MITSUBISHI : ME192608

**VR-H2009-176**

- *Soft Start
- *7 sec LRC
- *Short Circuit Protection
- *Voltage Set Point:14.5V
- *Regulated Voltage Control(RVC)
- *Requires RVC01 tester box for testing

Replaces

MITSUBISHI : 654

Unit No.

MITSUBISHI : A2TX1181,A2TX1781
NISSAN : 23100-1BN1A

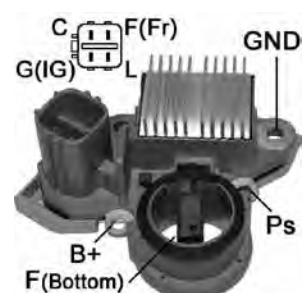
**VR-H2009-177**

- *C-F-G-L Terminals
- *Soft Start
- *8 sec. LRC
- *Short Circuit Protection
- *Voltage Set Point:14.5V

Replaces

MITSUBISHI : 5689202,5689202N

Unit No.

MITSUBISHI : A2TJ0091
SUZUKI : 31400-65J20

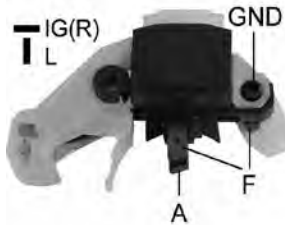
**VR-H2009-18**

- *R-L Terminals
- *Voltage Set Point:14.7V

Replaces

MAZDA : SE21-24-520
 MITSUBISHI : A866T03070,A866T03470,A866T18270
 MITSUBISHI MOTORS : MD607619

Unit No.

MAZDA : 4813-18-300
 MITSUBISHI : A1T32084,A2T15384,A2T43583,A5T22484
 MITSUBISHI MOTORS : MD013740,MD072582,MD087246

**VR-H2009-180**

- *Soft Start
- *5 sec LRC
- *Short Circuit Protection
- *Voltage Set Point:14.5V

Replaces

MITSUBISHI : 594,686

Unit No.

MITSUBISHI : A3TJ3591,A003TJ3591
 SUBARU : 23700-AA620

**VR-H2009-182**

- *Inactive Lamp
- *Voltage Set Point:14V
- *Work with PCM
- *** Traditional test method will immediately damage P-D regulator. Avoid damage using Mobiletron VR-H2009-66TF test fixture.

Unit No.

MAZDA : F82M-18-300
 MITSUBISHI : A2TC0591

**VR-H2009-183B**

- *24V
- *S Open Lamp Off
- *IG Open Lamp On
- *Voltage Set Point: 28.3V

Replaces

MITSUBISHI : 675,565,610

Unit No.

MITSUBISHI : A004TR5491AT,A004TR6393ZT,A4TR5491...

**VR-H2009-185**

- *Voltage Set Point: 14.6V

Replaces

MITSUBISHI : A866X09270,A866X09271
 MITSUBISHI MOTORS : MD611502

Unit No.

MITSUBISHI : A2T49577,A002T01976
 MITSUBISHI MOTORS : MD105606,MD099621

**VR-H2009-188**

- * Soft Start
- * 4 sec. LRC
- * Short Circuit Protection
- *Voltage Set Point: 14.4V

Unit No.

MITSUBISHI : A002TX1381,
 A2TX1381,92230902

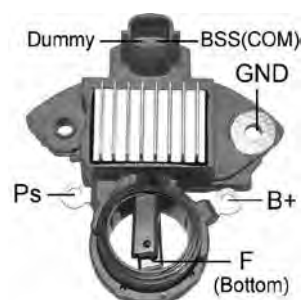
**VR-H2009-189**

- *A-Circuit
- *BSS 3 Connections
- *Requires COM01 test adaptor for testing
- *ID Code: 165

Replaces

MITSUBISHI : 630

Unit No.

MITSUBISHI : A002TX0481

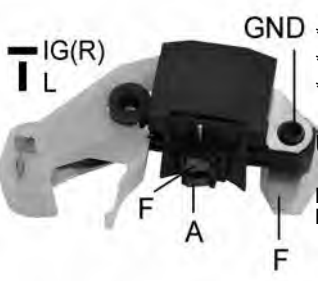
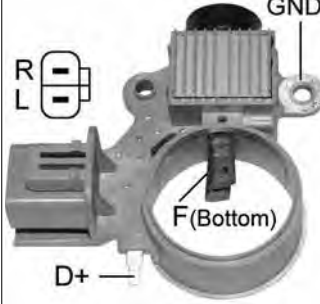
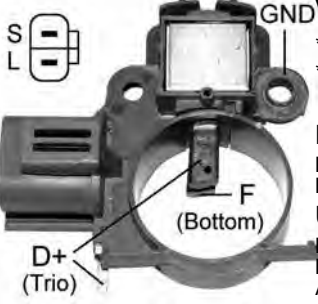
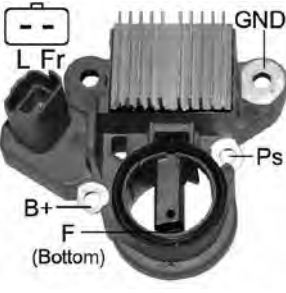
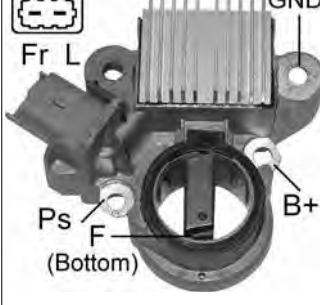
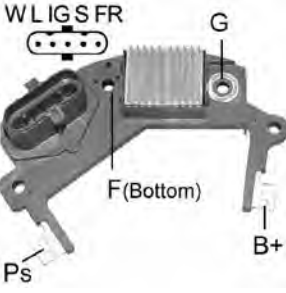
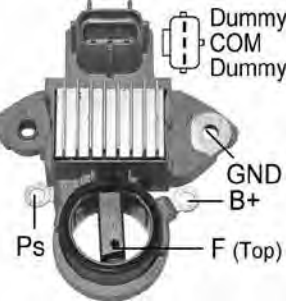
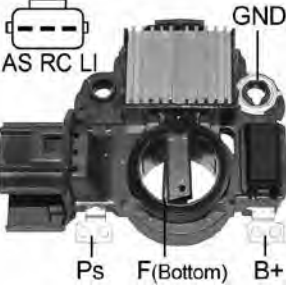
 <p>VR-H2009-19 *24V *R-L Terminals *Voltage Set Point:28.3V Unit No. MAZDA : SE17-24-520 MITSUBISHI : A866T03570</p>	 <p>VR-H2009-191B *24V *Voltage Set Point: 28.4V Replaces HYUNDAI : 37370-45100 Unit No. HYUNDAI : 37300-45100, 37300-45101</p>
 <p>VR-H2009-193B *24V *Voltage Set Point: 28.6V Replaces MAZDA : SLA1-18-W70 MITSUBISHI : A866X17872 Unit No. MAZDA : SLA1-18-300B MITSUBISHI : A2T73676,A002T73676</p>	<p>VR-H2009-194 Replaces MITSUBISHI : 623 Unit No. MITSUBISHI : A5TG0881ZEA,A5TG0881ZEB</p> <p style="text-align: center; font-size: 2em; opacity: 0.5;">PICTURE IS NOT AVAILABLE</p>
 <p>VR-H2009-195 * L-FR Terminals * Soft Start * 3 sec LRC * Voltage Set Point:14.5V Unit No. MITSUBISHI : A4TJ0382, A004TJ0382,A004TJ0382ZE... RENAULT : 8200654789,8200960538</p>	 <p>VR-H2009-196 *Fr-L Terminals *Soft Start *5 sec. LRC *Voltage Set Point: 14.5V Replaces MITSUBISHI : 530 Unit No. MITSUBISHI : A4TJ0084C</p>
 <p>VR-H2009-197B *24V *Voltage Set Point: 28.3V *Active Lamp *S Open Lamp Off *IG Open Lamp On</p>	<p>Replaces MITSUBISHI : 555 Unit No. MITSUBISHI : A9TU5591,A009TU5591A,A9TU5591A... SCANIA : 1777301,1536236,1777466</p>
 <p>VR-H2009-198 * Voltage Set Point: 13.7V * LIN-1 * 19200 Baud Rate (4 Byte) * Requires COM01 test adaptor for testing</p>	<p>Replaces MITSUBISHI : 695 Unit No. MITSUBISHI : A2TX2581ZD</p>
 <p>VR-H2009-199 *Voltage Set Point: 14.2V *Regulated Voltage Control(RVC)</p>	<p>Replaces MITSUBISHI : 628 Unit No. FORD : 5M5T-10300DA,5M5T-10300AA,5M5T-10300AB... MITSUBISHI : A4A3F38062,A004A3F30771,A004A3F38071...</p>

Brush Holder
 Voltage Regulator
 Repair Circuit
 Rectifier
 Diode Trio
 Diode
 Tester

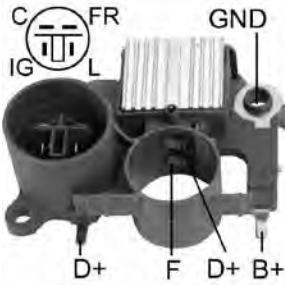
**VR-H2009-20**

*C-FR-IG-L Terminals
 *Repair Circuit:VR-H2009-20S
 *Voltage Set Point:14.6V

Replaces

MITSUBISHI : A866T38570,A866X13670,A866X22072

Unit No.

HONDA : 31100-AHG-A03
MITSUBISHI : A1T02291,A1T02292,A1T04892,A5T04072...

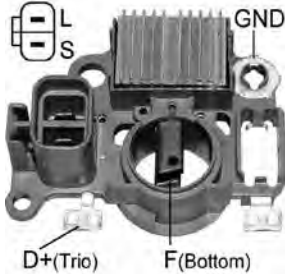
**VR-H2009-201**

*Voltage Set Point: 14.5V

Replaces

MITSUBISHI : A866X32672,992

Unit No.

MITSUBISHI :
 A7T03371A,A7T03771A
NISSAN : 23100-50K10

VR-H2009-203

*A-Circuit
 *Voltage Set Point: 14.5V

Replaces

MITSUBISHI : A866X41072

Unit No.

HYUNDAI : 37300-45001
MITSUBISHI : A2TN1199A,A2T
 N1199AT,A2TN1798A...
MITSUBISHI MOTORS :
 MD366051,MD366052

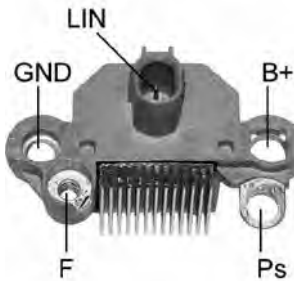
**VR-H2009-204**

*Voltage Set Point: 14.4V
 * LIN 2
 * 9600 & 19200 Baud Rate
 (4 Byte)
 * Requires COM01 test
 adaptor for testing

Unit No.

HONDA : 31100-5R0-004,
 31100-5R7-A01...
MITSUBISHI : A5TZ0091

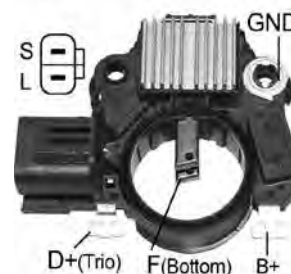
**VR-H2009-205B**

*24V
 *Voltage Set Point: 28.4V

Replaces

MITSUBISHI : 497

Unit No.

MITSUBISHI : A3TN5379,ME04
 9321,A3TN5379ZC,ME08887...

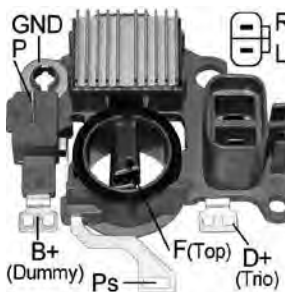
**VR-H2009-207B**

*24V
 *Voltage Set Point: 28.7V

Replaces

MITSUBISHI : 328

Unit No.

MITSUBISHI :
 A3TA8199,A003TA8199
MITSUBISHI MOTORS :
 ME108147

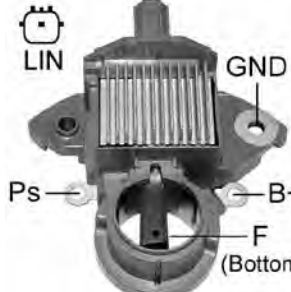
**VR-H2009-208**

*24V
 *Voltage Set Point: 28.4V

Replaces

MITSUBISHI : 700

Unit No.

HONDA : 31100-5A2-A02
MITSUBISHI : A5TL0581ZC

**VR-H2009-209**

* Voltage Set Point: 14V
 **Traditional test method will
 immediately damage P-D
 regulator. Avoid damage using
 Mobiletron VR-H2009-66TF
 test fixture.

Unit No.

MITSUBISHI : A005TL0491,
 A5TL0491,A2TX3081

**VR-H2009-21**

*24V
 *R-L Terminals
 *Voltage Set Point:28.3V

Replaces

MITSUBISHI : A866T02070

Unit No.

MITSUBISHI :
 40Q,A641,T46070

**VR-H2009-210**

*Soft Start
 *0.5 sec. LRC
 *Short Circuit Protection
 *Voltage Set Point:14.5V

Unit No.

MITSUBISHI :
 A2TL0091,A002TL0091

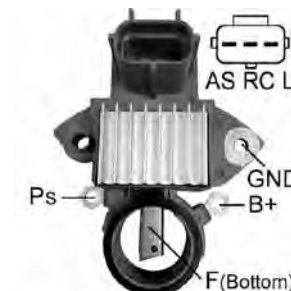
**VR-H2009-212**

*Voltage Set Point: 14.0V
 *Regulated Voltage
 Control(RVC)
 *Requires RVC01 tester box
 for testing

Unit No.

MITSUBISHI : A3TX1691

PICTURE
IS NOT
AVAILABLE

VR-H2009-218

Unit No.

FORD : FL1T-10300-AA
MITSUBISHI : A003TV0691ZC



VR-H2009-22

*S-L Terminals
*Repair Circuit:VR-H2009-43S
*Voltage Set Point:14.5V

Replaces

MAZDA : B64J-18-W70,JE48-18-W70
MITSUBISHI : A866X20472,A866X20972,A866X27772...

Unit No.

FORD : FS1118300A
MAZDA : B366-18-300,B3C7-18-300,B61P-18-300...
MITSUBISHI : A2T33191,A2T33891,A2T33991,A2T35177...

PICTURE
IS NOT
AVAILABLE

VR-H2009-220

Unit No.
GM : 13506528



VR-H2009-23

*S-L Terminals
*Repair Circuit:VR-H2009-7S
*Voltage Set Point:14.6V

Replaces

MITSUBISHI : A866X08472
NISSAN : 23215-58S10

Unit No.

MITSUBISHI : A5R41592,
A5T41592,A5T41592B
NISSAN : 23100-53A10,
23100-53A11



VR-H2009-24

*S-L Terminals
*Repair Circuit:VR-H2009-10S
*Voltage Set Point:14.5V

Replaces

FORD : F0BZ-10316A
MITSUBISHI : A866X17170,A866X17172

Unit No.

FORD : F0CZ-10346B,F0BZ-10346A
MAZDA : B113-18-300B,BP02-18-300A
MITSUBISHI : A5T00877,A5T00972,A5T02777



VR-H2009-25

*I-S(D)-A Terminals
*Repair Circuit:VR-H2009-10AS
*Voltage Set Point:14.5V

Replaces

FORD : E9PZ-10316B
MITSUBISHI : A866X15472
MOTORCRAFT : GRE797

Unit No.

FORD : E9SF-10300DA,E9SZ-10346A
MITSUBISHI : A4T00796
MOTORCRAFT : GLE-265

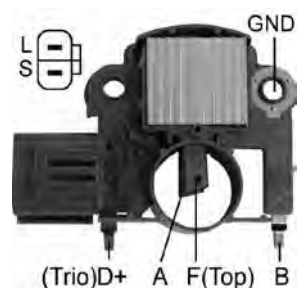

VR-H2009-26

*S-L Terminals
*Repair Circuit:VR-H2009-10S
*Voltage Set Point:14.5V

Replaces

FORD : F02Z-10316A,GRE799
MAZDA : F285-18-W70
MITSUBISHI : A866T17972,A866X00179,A866X17972...
MOTORCRAFT : GRE799
NISSAN : F285-18-W70A,23215-77A10

Unit No.

MITSUBISHI : A002T19991,A002T34477,A003T06791...

**VR-H2009-27**

*S-L Terminals
*Repair Circuit:VR-H2009-7S
*Voltage Set Point:14.6V

Replaces

MITSUBISHI : A866X06470,A866X06471
NISSAN : 23133-08E15,23313-08515

Unit No.

MITSUBISHI : A2T47794
NISSAN : 23100-51S10

**VR-H2009-28**

*S-L Terminals
*Repair Circuit:VR-H2009-5S
*Voltage Set Point:14.6V

Replaces

MITSUBISHI : A866X09171,A866T09170,A866X09170...
MITSUBISHI MOTORS : MD611481,MD611668

Unit No.

MITSUBISHI : A2T01384,A2T01483,A2T01583,A2T01683...
MITSUBISHI MOTORS : MD102864,MD102865,MD103372,MD10337

**VR-H2009-3**

*S-L Terminals
*Voltage Set Point:14.7V

Replaces

LUCAS : 21511095,21511116,UCJ207
MAGNETI MARELLI : 940038075
MAZDA : 8574-24-520
MITSUBISHI : A866T00870,A866T02970
NISSAN : 23215-P3017,23215-W7110

Unit No.

MAZDA : 8574-18-300
MITSUBISHI : A1T22971,A1T25083,A2T24971,A2T40971...
NISSAN : 23100-01B10,23100-01B15,23100-01F10...

**VR-H2009-30**

*S-L Terminals
*Voltage Set Point:14.4V

Replaces

MITSUBISHI : A866X12682
MITSUBISHI MOTORS : MD160671

Unit No.

MITSUBISHI : A3T01877,A3T01877B,A3T04177,A3T04178...

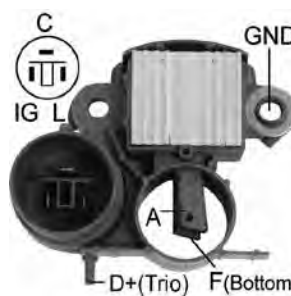
**VR-H2009-32**

*C-IG-L Terminals
*Voltage Set Point:14.6V

Replaces

HONDA : 31150-PEO-9270
MITSUBISHI : A866X08270,A866X08271

Unit No.

HONDA : 31100-PEO-906,31100-PEO-9270
MITSUBISHI : A1T01691

**VR-H2009-33**

*S-L Terminals
*Repair Circuit:VR-H2009-10S
*Voltage Set Point:14.5V

Replaces

MAZDA : JE15-18-W70A
MITSUBISHI : A866X17072,A866X21072

Unit No.

FORD : F2JY-10346A
MAZDA : JE15-18-300A,JE27-18-300,JE28-18-300...
MITSUBISHI : A2T13977,A2T18177,A2T18277,A2T18874...
MITSUBISHI MOTORS : MD150657

**VR-H2009-34**

*S-L Terminals
*Repair Circuit:VR-H2009-10AS
*Voltage Set Point:14.5V

Replaces

MITSUBISHI : A866X15770

Unit No.

MITSUBISHI : A1T03391,A1T03791
SUBARU : 23700-KA240,23700-KA360

**VR-H2009-35**

*S-L Terminals
*Repair Circuit:VR-H2009-10S
*Voltage Set Point:14.5V

Replaces

MITSUBISHI : A866X18972

Unit No.

MAZDA : F2G8-18-300
MITSUBISHI : A5T02377

**VR-H2009-37**

*S-L Terminals
 *S Open Lamp ON
 *Repair Circuit:VR-H2009-43S
 *Voltage Set Point:14.5V

Replaces

MITSUBISHI : A866X23172

Unit No.

MITSUBISHI : A2T38391,A4T02591,AT506591

**VR-H2009-38**

*S-L Terminals
 *S Open Lamp OFF
 *Repair Circuit:VR-H2009-38S
 *Voltage Set Point:14.6V

Replaces

MITSUBISHI : A860X25472,A866X22272,A866X39772
MITSUBISHI MOTORS : MD618569

Unit No.

FORD : F3XA-10300AC
MITSUBISHI : A2T34892,A2T34991,A2T34992,A2T35091...
MITSUBISHI MOTORS : MD175810,MD175811,MD177244,MD18427
NISSAN : 23100-OB00

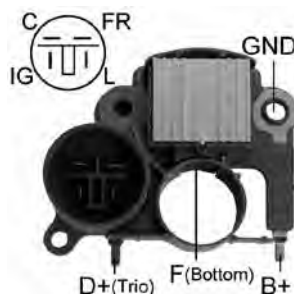
**VR-H2009-40**

*C-FR-IG-L
 *Repair Circuit:
 VR-H2009-40S
 *Voltage Set Point:14.6V

Replaces

MITSUBISHI : A866X22081

Unit No.

HONDA : 31100-O08-014,04314-P08-014
MITSUBISHI : A5T04092

**VR-H2009-41**

*S-L Terminals
 *Repair Circuit:VR-H2009-11S
 *Voltage Set Point:14.6V

Replaces

MITSUBISHI : A866X11772,A866X19072
MITSUBISHI MOTORS : MD611743

Unit No.

MITSUBISHI : A4T01493,A4T01793,A4T01893,A4T02991...

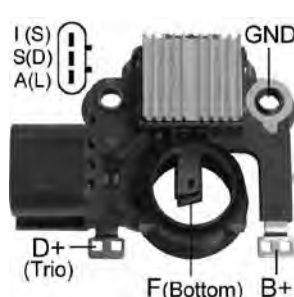
**VR-H2009-43**

*I-S(D)-A Terminals
 *Repair Circuit:VR-H2009-43S
 *Voltage Set Point:14.5V

Replaces

MITSUBISHI : A866X24272

Unit No.

FORD : F3DZ-10346A,
 F3LU-10300BC
MITSUBISHI :
 A6T41491,A6T41591

**VR-H2009-44**

*D-IG-L Terminals
 *Repair Circuit:VR-H2009-44S
 *Voltage Set Point:14.7V

Replaces

MITSUBISHI : A866X23772

Unit No.

MITSUBISHI :
 A5T07091ZC,A5T07092ZC
SUZUKI : 31400-50G10,
 31400-60ACI,31400-63BD2

**VR-H2009-45**

*S-L Terminals
 *Repair Circuit:VR-H2009-45S
 *Lamp Short Circuit Protection
 *Voltage Set Point:14.5V

Replaces

MITSUBISHI : A866X22472,A866X23072
NISSAN : 23215-64J13

Unit No.

MITSUBISHI : A2T33593,A7T02874
NISSAN : 23100-OP515

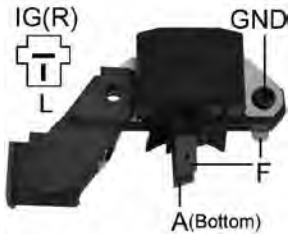
**VR-H2009-46**

*R-L Terminals
*Voltage Set Point:14.7V

Replaces

MITSUBISHI : A866T08570
MITSUBISHI MOTORS : ME700556

Unit No.

MITSUBISHI : A2T32583
MITSUBISHI MOTORS : ME017588

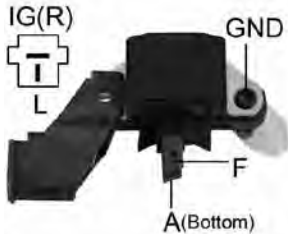
**VR-H2009-47**

*24V
*R-L Terminals
*Voltage Set Point:28.3V

Replaces

MITSUBISHI : A866T06870
MITSUBISHI MOTORS : ME700635

Unit No.

MITSUBISHI : A2T32583,A2T72286,A4T57789,A4T57886...
MITSUBISHI MOTORS : ME017563,ME017588,ME037640,ME03764

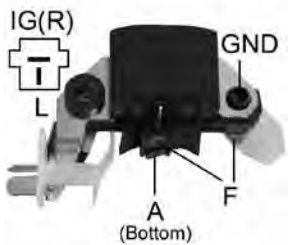
**VR-H2009-48**

*R-L Terminals
*For Fuso Truck
*Voltage Set Point:14.7V

Replaces

MITSUBISHI : A866T06570

Unit No.

MITSUBISHI : A5T22578,A5T22583
MITSUBISHI MOTORS : ME001570,ME007577

**VR-H2009-49**

*Repair Circuit:
VR-H2009-49S
*For 23mm OD slip ring
*Voltage Set Point:14.6V

Replaces

MITSUBISHI : A866X23200

Unit No.

MITSUBISHI : A2T13391C,A2T14591,A2T14592,A2T17491...

**VR-H2009-4A**

*Original part number is VR-MD02
*For Use on Kia Pride 45A Alternator

Replaces

MAZDA : E356-18-W70,E358-18-W70,FE65-24-520...
MITSUBISHI : A866T05272,A866X04870,A866X04871...
MITSUBISHI MOTORS : MD611032,MD611146,MD618207...

Unit No.

KIA : 02131-9021,OK72A-18300

**VR-H2009-4H**

*R-L Terminals
*Repair Circuit:VR-H2009-4S
*Voltage Set Point:14.7V

Replaces

FORD : E8GY-10316,E8JY-10316
HYUNDAI : 37370-21200
MAGNETI MARELLI : 940038085
MAZDA : E356-18-W70,FE65-24-520,FE79-24-520
MITSUBISHI : A866X04871,A866X04872,A866X05470...
MITSUBISHI MOTORS : MD611032,MD611146
NISSAN : 23215-P0410

Unit No.

FORD : E8GY-10346A,E8GY-10346B,E9BZ-10346A
HYUNDAI : 37300-21013,37300-21320,37900-21030
MANDO : AR160A
MAZDA : B359-18-300,B655-18-300,B655-18-300A...
MITSUBISHI : A1T01991,A1T40391,A1T40491,A1T40791...
MITSUBISHI MOTORS : MD069978,MD073067,MD074644,MD07464



VR-H2009-50

*C-FR-IG-L Terminals
 *Repair Circuit:VR-H2009-50S
 *Voltage Set Point:14.5V

Replaces
 MITSUBISHI : A866X26641
Unit No.
 HONDA : AHGA19
 MITSUBISHI : A5T06491ZC



VR-H2009-51

*S-IG-L Terminals
 *Voltage Set Point:14.5V

Replaces
 MITSUBISHI : A866T01871,A866X01871
 NISSAN : 23215-W1710
Unit No.
 MAZDA : 4813-18-300
 MITSUBISHI : A2T25377,A2T25378,A2T25578,A2T25584...
 NISSAN : 23100-17S10,23100-17S15,23100-G3710...



VR-H2009-53

*R-L Terminals
 *Voltage Set Point:14.5V

Replaces
 MAZDA : 8599-24-520
 MITSUBISHI : A866X02170
Unit No.
 MAZDA : 8599-18-300,S201-18-300,S201-18-300A...
 MITSUBISHI : A1T23479,A1T32779,A2T25470



VR-H2009-54

*R-L Terminals
 *Voltage Set Point:14.5V

Replaces
 MITSUBISHI : A866X01670
 MITSUBISHI MOTORS : MD607500
Unit No.
 MITSUBISHI : A2T24884,A3T21584
 MITSUBISHI MOTORS : MD050190,MD050194



VR-H2009-56

*S-L Terminals
 *Voltage Set Point:14.6V

Replaces
 MITSUBISHI : A866X05870
 NISSAN : 23215-05E16
Unit No.
 MITSUBISHI : A3T35278,A3T35299
 NISSAN : 23100-05E18, 23100-05E70



VR-H2009-57

*R-L Terminals
 *Voltage Set Point:14.7V

Replaces
 MITSUBISHI : A866X25872
Unit No.
 MITSUBISHI : A7T02874

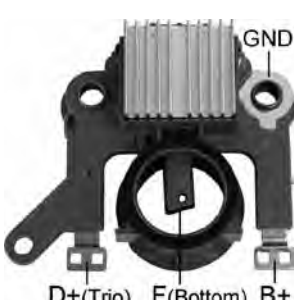

VR-H2009-58

*Repair Circuit:VR-H2009-58S
 *Voltage Set Point:14.6V

Unit No.
 MITSUBISHI : A2TA0591,A2TA0592,A2TA1981, A2TA1994...

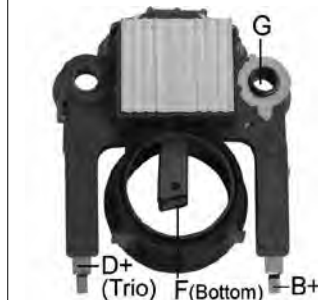

VR-H2009-59

*For 28mm OD slip ring
 *Voltage Set Point:14.6V

Replaces
 MITSUBISHI : 263
Unit No.
 MITSUBISHI : A2T34598,A4T00891, A4T02891,A4T02892...

**VR-H2009-62**

*L-IG-FR Terminals
*Voltage Set Point:14.5V

Replaces

MITSUBISHI : A866X31882

Unit No.

MITSUBISHI : A5TA1191ZC

**VR-H2009-63**

*Inactive Lamp
*R-L Terminals
*Voltage Set Point:14.7V
*w/o capacitor

Replaces

MITSUBISHI : A866X26172

MITSUBISHI MOTORS : MD618845

Unit No.

MITSUBISHI : A1T06391,A1T06672,A1T06791,A1T06891...

MITSUBISHI MOTORS : MD300720,MD305885,MD305886,MD30933

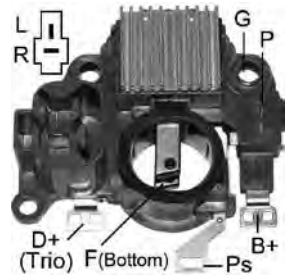
**VR-H2009-64**

*R-L Terminals
*Voltage Set Point:14.7V

Replaces

MITSUBISHI : A866X24572

Unit No.

MITSUBISHI : A7T02077A,A7TA0477

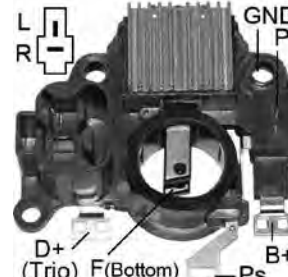
**VR-H2009-64A**

*R-L Terminals
*w/ Choke
*Voltage Set Point:14.7V
*Regitar No.:VRH2009-64M

Replaces

MITSUBISHI : MM502585

**VR-H2009-65**

*S-L Terminals
*Voltage Set Point:14.5V

Replaces

MITSUBISHI : A866X17272

Unit No.

MITSUBISHI : A2T09591
NISSAN : 23700-AA180

**VR-H2009-66TF**

*VR-H2009-66 Test Fixture

**VR-H2009-67**

*S-L Terminals
*Voltage Set Point:14.5V

Replaces

MAZDA : RGF1-18-W70

MITSUBISHI : A866X24972,A866X25572,A866X24472...

MITSUBISHI MOTORS : MD618735,MD619167

Unit No.

HYUNDAI : 37300-42354,37300-42356

MITSUBISHI : A2T37976,A2TN0076,A2TN0199,A2TN0299...

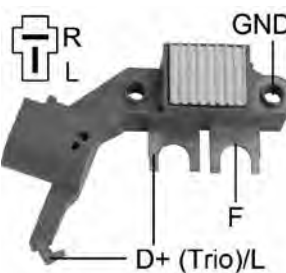
**VR-H2009-69**

*R-L Terminals
*Voltage Set Point:14.7V

Replaces

MITSUBISHI : A866X08971,A866X23972

MITSUBISHI MOTORS : ME700799,ME701260

Unit No.

MITSUBISHI : A004T25788

MITSUBISHI MOTORS : ME015164

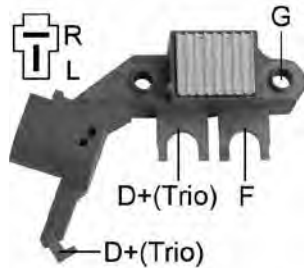
**VR-H2009-69B**

*24V
*R-L Terminals
*Voltage Set Point:28.6V

Replaces

MITSUBISHI : A866X08871,A866X19972
MITSUBISHI MOTORS : ME700783,ME701196

Unit No.

MITSUBISHI : A4T58289,A4T58686,A4T58689,A4T58699...
MITSUBISHI MOTORS : ME057701,ME060076,ME077137,
ME07713

**VR-H2009-6A**

*S-L Terminals
*Voltage Set Point:14.6V
*For Use on Kia Pride 65A
Alternator

Unit No.

KIA : KK339-18300
MANDO : AB150021

**VR-H2009-6H**

*S-L Terminals
*Repair Circuit:VR-H2009-5S
*Voltage Set Point:14.6V

Replaces

LUCAS : 21513125,UCJ235
MAGNETI MARELLI : 940038088
MITSUBISHI : A866T05270,A866X05270,A866X05272...
MITSUBISHI MOTORS : MD611432,MD611565,MD611588...
NISSAN : 23125-04P10,23215-04P10

Unit No.

HYUNDAI : 37300-32520,37300-35020
MITSUBISHI : A2T02271,A2T02471,A2T03471,A2T03477...
MITSUBISHI MOTORS : MD061150,MD102084,MD102085,
MD10208
NISSAN : 23100-02E10,23100-02E11,23100-02E15...

**VR-H2009-6HL**

*S-L Terminals
*Voltage Set Point:14.4V
** For Iran Market Only

Replaces

KIA : KK137-24-W70

Unit No.

KIA : M13NI-18-300B

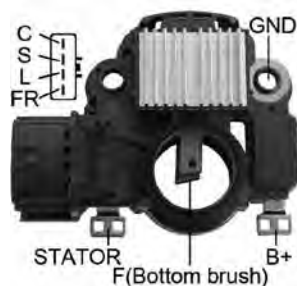
**VR-H2009-70A**

*C-S-L-FR Terminals
*Soft Start
*Repair Circuit:VR-H2009-70AS
*Voltage Set Point:14.4V

Replaces

MITSUBISHI : A866X34172,MD619268
MITSUBISHI MOTORS : MD619268

Unit No.

MITSUBISHI : A2TA4991,A2TA5191,A2TA5192,A2TA5391...

**VR-H2009-71**

*C-F(FR)-IG-L Terminals
*Voltage Set Point:14.5V

Replaces

MITSUBISHI : 3177203J,504
MITSUBISHI MOTORS : ME10997D

Unit No.

HONDA : 31150-P2E-A01
MITSUBISHI : A5TA0991

**VR-H2009-73**

*C-S-L-FR Terminals
 *Repair Circuit:VR-H2009-73S
 *Voltage Set Point:14.4V

Replaces

MITSUBISHI : A866X28572,285
MITSUBISHI MOTORS : MD618957

Unit No.

MITSUBISHI : A2T82791,A2TA0891ZC,A5TA0291
MITSUBISHI MOTORS : MD313392

**VR-H2009-75**

*Excitation: Trio/A
 *Voltage Set Point:14.6V

Replaces

MANDO : 809163,811883,A500C0111
MELROE : 6659393
VALEO : 809163,811883,A500C0111

Unit No.

MANDO : AC155515,AC155643,A000B0331,A000B0431...
MELROE : 6661611

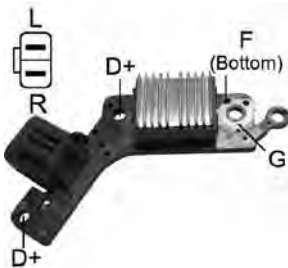
**VR-H2009-77B**

*24V
 *L-R Terminals
 *Voltage Set Point:28.5V

Replaces

MITSUBISHI : A866X26070,A866X26072
MITSUBISHI MOTORS : ME701302

Unit No.

MITSUBISHI : A004T40286,A004T40289,A004T40386...
MITSUBISHI MOTORS : ME017632,ME077788,ME077789,ME07779

**VR-H2009-78**

*L-S Terminals
 *Inactive Lamp
 *S Open Lamp Off
 *Voltage Set Point: 14.5V

Replaces

MITSUBISHI : A866T09780,A866T09782

Unit No.

HYUNDAI : 37300-32800,37300-33010,37300-33013...
MANDO : AB175020,AB190025,AB190072,AB190119
MITSUBISHI : A3T03393
MITSUBISHI MOTORS : MD136838

**VR-H2009-79**

*S-L Terminals
 *Voltage Set Point:14.5V

Replaces

MITSUBISHI : A866X27572,275
MITSUBISHI MOTORS : ME701363

Unit No.

MITSUBISHI : A2TA3098,A3T09198,A3T09199,A3T09698...

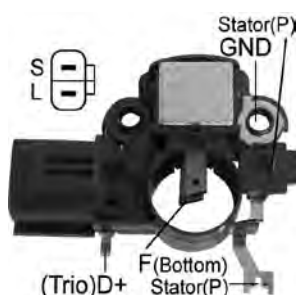
**VR-H2009-7H**

*S-L Terminals
 *Repair Circuit:VR-H2009-7S
 *Voltage Set Point:14.6V

Replaces

FORD : E8GY-10316B,E8GZ-10316A
MAGNETI MARELLI : 940038084
MAZDA : B675-18-W70,B675-18-70A
MITSUBISHI : A866X12770,A866X12772,A866X12780...

Unit No.

FORD : E8GY-10346C,E8GY-10346D,E92Z-10346A...
MAZDA : B675-18-300A,B675-18-300B,F202-18-300...
MITSUBISHI : A2T05772,A2T05892,A2T05893,A2T20091

**VR-H2009-80**

- *L-R Terminals
- *Voltage Set Point:14.7V

Replaces

MITSUBISHI : A866X34997,349

Unit No.

MITSUBISHI : A2T38776,A2T36776,A2TN2384ZJ
MITSUBISHI MOTORS : MD344310

**VR-H2009-80B**

- *24V
- *R-L Terminals
- *Repair Circuit: VR-H2009-80BS
- *Voltage Set Point:28.6V

Replaces

MITSUBISHI : A866X28372,A866X41272,ME701399,283
MITSUBISHI MOTORS : ME701399

Unit No.

MITSUBISHI : A3T75883,A3TN5188,A3TN5288
MITSUBISHI MOTORS : ME017615

**VR-H2009-82**

- *D-L Terminals
- *Voltage Set Point:14.3V

Replaces

MITSUBISHI : A866X40371,403

Unit No.

MITSUBISHI : A3TN1791

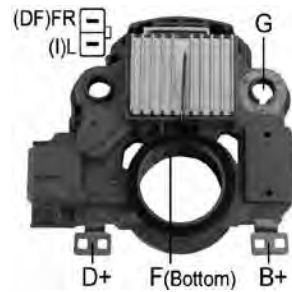
**VR-H2009-83**

- *FR-L Terminals
- *Voltage Set Point:14.5V

Replaces

MITSUBISHI : A866X35872,358

Unit No.

MITSUBISHI : A5TA2591,A5TA4391,
A5TA6591

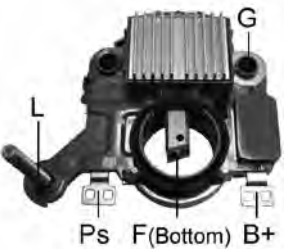
**VR-H2009-85**

- *Active Lamp
- *Short Circuit Protection
- *Voltage Set Point:14.6V

Replaces

MITSUBISHI : 234309,362,499,458

Unit No.

MITSUBISHI : A2TB4891A

**VR-H2009-88**

- *C-FR-IG-L Terminals
- *Repair Circuit:VR-H2009-88S
- *Voltage Set Point:14.5V

Replaces

MITSUBISHI : A866T29570,A866X29582,VR295

Unit No.

HONDA : 31100-P0G-A03,04314-P0G-A02
MITSUBISHI : A2TA2191

**VR-H2009-8H**

- *S-L Terminals
- *Repair Circuit:VR-H2009-7S
- *Voltage Set Point:14.6V

Replaces

LUCAS : 21513126,UCJ233
MITSUBISHI : A866X08070,A866X08071,A866X08072
NISSAN : 23215-17B10,23215-51S10

Unit No.

MITSUBISHI : A2T02394,A2T02394B,A2T46395,A2T46395B...
NISSAN : 23100-12C10,23100-12C11,23100-26E10...

**VR-H2009-90**

- *Inactive Lamp
- *L-IG-D Terminals
- *Short Circuit Protection
- *Voltage Set Point:14.6V

Replaces

GM : 91174657

Unit No.

GM : 30020754

MITSUBISHI : A5TA4291,A5TA4291ZC

SUZUKI : 31400-65D00,31400-65D01

**VR-H2009-92**

- *C-IG-L Terminals
- *Voltage Setting:14.5V

Replaces

MITSUBISHI : A866X13571

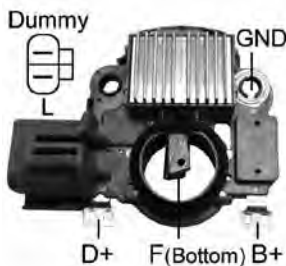
**VR-H2009-93**

- * D-L Terminals
- * Inactive Lamp
- * L Terminal Does Not Drive Choke
- * Voltage Set Point: 14.5V

Replaces

MITSUBISHI : 517

Unit No.

MITSUBISHI : A003TB5391,A3TA0991A,A3TB5391

MITSUBISHI MOTORS : MD354802

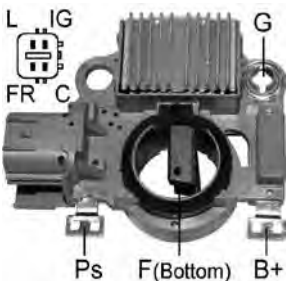
**VR-H2009-94**

- *L-IG-FR-C Terminals
- *Voltage Set Point: 14.5V

Replaces

MITSUBISHI : 487,A866X48782

Unit No.

HONDA : 31100-PND-004

MITSUBISHI : A2TB7591,A2TC0691,AHGA61,AHGA55

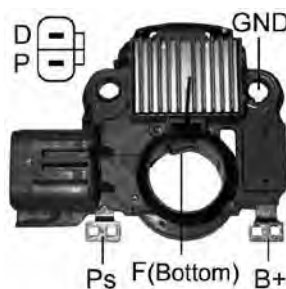
**VR-H2009-95**

- * Inactive Lamp
- * D-P Terminals
- * Repair Circuit: VR-H2009-95S
- *** Traditional test method will immediately damage P-D regulator. Avoid damage using Mobiletron VR-H2009-66TF test fixture.

Replaces

MITSUBISHI : A866X35472,A866X34572,475

Unit No.

MITSUBISHI : A2TB0091,A2TB2391,A2TB5491

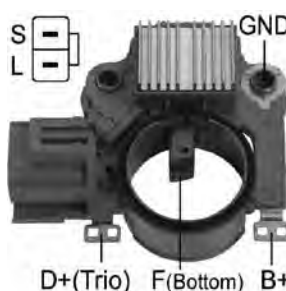
**VR-H2009-96B**

- *24V
- *S-L Terminals
- *Voltage Set Point:28.4V
- *L Terminal Does Not Drive Choke

Replaces

MITSUBISHI : A866X38672

Unit No.

MAZDA : A2T74684 ,A2T74776, A2T74876,A2T74976...

**VR-H2009-97**

- *L-IG-D Terminals
- *6 sec. LRC
- *L Terminal Does Not Drive Choke
- *Voltage Set Point: 14.5V

Replaces

MITSUBISHI : A866X45072



VR-H2009-98

- *AS-RC-LI Terminals
- *W/Capacitor 2.2uF
- *Voltage Set Point:14.0V
- *Regulated Voltage Control(RVC)
- *Requires RVC01 tester box for testing

Replaces

MITSUBISHI : A866T52970,529

Unit No.

FORD : 4W73-10300AC,4W7Z-10346AC,6E5T-10300AB...
MITSUBISHI : A004TJ0181ZC,A3TJ0891,A3TJ0891ZC...



VR-H2009-99

- * Inactive Lamp
- * L-S Terminals
- * Repair Circuit:VR-H2009-99S
- * Soft Start
- * Load Response Control w/Capacitor
- * w/o Drive Choke
- * Voltage Set Point:14.5V

Replaces

MITSUBISHI : A866X37272,A866X47672,476

Unit No.

MITSUBISHI : A2T05892C,A2T33191A,A2T33991A,A2T36578A...
NISSAN : 23100-AM610



VR-H2009-9H

- *R-L Terminals
- *Repair Circuit:VR-H2009-4S
- *Voltage Set Point:14.6V

Replaces

FORD : E7GZ-10316A,F0BZ-10316A
LUCAS : 21513133
MAGNETI MARELLI : 940038086
MAZDA : BF1462,FE85-18-W70
MITSUBISHI : A866X07570,A866X07572
MOTORCRAFT : GRE800

Unit No.

FORD : E7GZ-10346A,E8BZ-10346A,E8BZ-10346B...
MAZDA : B101-18-300,B10-18-300A,B603-18-300...
MITSUBISHI : A5T16471,A5T30977,A5T31177,A5T31971...

Brush Holder

Voltage Regulator

Repair Circuit

Rectifier

Diode Trio

Diode

Tester



VR-H2003-1B

*24V
 *B+ - F Terminals
 *Voltage Set Point:28.5V

Replaces

ISUZU : 1-81251-004-0,1-81251-024-0,5-81251-012-0
 NIKKO : 1-44000-0580,1-44000-0730

Unit No.

ISUZU : 1-81200-206-0,1-81200-209-0...
 NIKKO : 0-33000-0050,0-33000-0060,0-33000-0071...



VR-H2003-2B

*24V
 *Voltage Set Point:28.8V

Replaces

NIKKO : 1-44000-0900,
 0-33719-0030,0-33719-0031...



VR-H2002-1

*24V
 *R-L-F-E-LA-N Terminals
 *Voltage Set Point:28.3V

Replaces

HINO : 27700-1700
 NISSAN : 23500-Z9007
 SAWAFUJI : 1291-008-00X0
 TOYOTA : 27700-1700

Unit No.

NISSAN : 23099-96510,23099-Z5615,23099-Z5665...
 SAWAFUJI : 0201-102-2921,0201-102-2963...
 TOYOTA : 27040-1811



VR-H2002-2

*24V
 *L-F-C-E Terminals
 *Voltage Set Point:28.7V

Replaces

NISSAN : 23500-Z9003
 SAWAFUJI : 1291-007-00X0

Unit No.

NISSAN : 23099-96504,23099-965503,23099-Z5604...
 SAWAFUJI : 0201-102-1020,0201-102-1210...
 TOYOTA : 27040-1400,27040-1410,27040-1440...



VR-H2002-3

*24V
 *R-L-F-C-E Terminals
 *Voltage Set Point:28.7V

Replaces

SAWAFUJI : 1291-006-00X0

**VR-V0030**

- *Soft Start
- *8.5 sec. LRC
- *Short Circuit Protection
- *Voltage Set Point: 14.6V

Replaces

VALEO : 2650030

Unit No.NISSAN : 23100-5Z000,
23100-7Y020

VALEO : 2650031,2650047

**VR-V005**

- *Voltage Set Point: 14.5V

Unit No.

HYUNDAI : 37300-23720

**VR-V014**

- *Voltage Set Point: 14.4V

Unit No.PEUGEOT : 9611366880
STAM SANAT : 9007561825
VALEO : SG9B091**VR-V015**

- *Soft Start
- *4.0 sec LRC
- *Short Circuit Protection
- *Voltage Set Point :14.5V

Unit No.HYUNDAI : 37300-3C250
VALEO : TG12C057**VR-V016**

- *Voltage Set Point: 14.5V
- *Same as VR-V014 but Single-chip version, TO3 package

Unit No.PEUGEOT : 9611366880
STAM SANAT : 9007561825
VALEO : SG9B091**VR-V0219**

- *Soft Start
- *2.5 sec. LRC
- *Short Circuit Protection
- *Voltage Set Point: 14.6V

Replaces

VALEO : 2650219,2650348,2650473

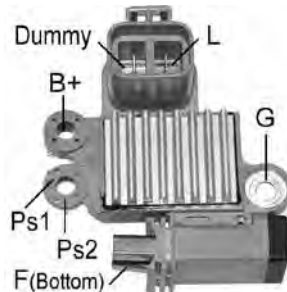
Unit No.VALEO : TG12C027,TG12C040,
TG12C042,TG12C043...**VR-V024**

- *Soft Start
- *Short Circuit Protection
- *Self Exciting
- *Voltage Set Point: 14.5V

Unit No.

JHECO: JFZ1929C

**VR-V0441**

- *Voltage Set Point: 13.8V
- *Soft Start
- *2.5 sec. LRC
- *Short Circuit Protection
- *Regulated Voltage Control(RVC)
- *Requires RVC01 tester box for testing
- *Regitar No.:VRVA0557

Replaces

VALEO : 2650441,2650561,15926088,2650557

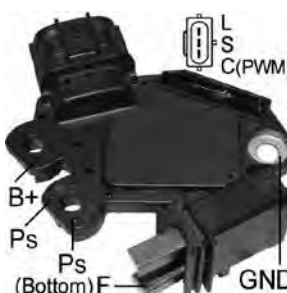

Unit No.GM : 15201678,15215546,15251755,15784559...
VALEO : TG10S012,TG10S016,TG10S017,TG10S022...**VR-V0447**

- *C-S-L Terminals
- *Soft Start
- *Short Circuit Protection
- *Voltage Set Point:14.5V
- *Regulated Voltage Control(RVC)
- *Requires RVC01 tester box for testing

Replaces

VALEO : 2650447,2606243A

Unit No.NISSAN : 23100-JA02A,23100-JA02B,23100-ZH00A...
SUZUKI : 31400-82Z10
VALEO : TG12C032,2650364A,2650364B,2650538...

<p>PICTURE IS NOT AVAILABLE</p>	<p>VR-V0572 LIN</p> <p>Unit No. TOYOTA : 27060-0Q140 VALEO : FG9T013,FG9T011</p>	<p>VR-V1610</p> <p>Replaces VALEO : 593362,YM1610F,2541939B,2542349,2542482</p> <p>Unit No. VALEO : 2541997,2541998,2542294,A11V195...</p>	<p>PICTURE IS NOT AVAILABLE</p>
<p>PICTURE IS NOT AVAILABLE</p>	<p>VR-V1658</p> <p>Replaces VALEO : 593434,593466,YM1658</p> <p>Unit No. VALEO : 2542298A,SG12S019</p>	<p>VR-V2118</p> <p>*L-IG Terminals *Voltage Set Point: 14.8V</p> <p>Unit No. STAM SANAT : SSG7S039,4702118A</p>	
	<p>VR-V2263</p> <p>*Requires COM01 test adaptor for testing</p> <p>Replaces VALEO : 593536,2612263,2542655</p> <p>Unit No. BMW : 12317516098,12317516721,12317516722 VALEO : SG9B050,437374,439418,SG9B040,2542458...</p>	<p>PICTURE IS NOT AVAILABLE</p>	<p>VR-V2499</p> <p>*Soft Start *2.5 sec. LRC *Short Circuit Protection *Voltage Set Point:14.6V</p> <p>Replaces VALEO : 2542499</p> <p>Unit No. GM : 10317648,10327514,10350160 VALEO : 2650010,2650011B,2650017A,SG10S029...</p>
<p>PICTURE IS NOT AVAILABLE</p>	<p>VR-V2599</p> <p>Replaces VALEO : 2542599,593532</p> <p>Unit No. VALEO : 2542564,2542564A</p>	<p>PICTURE IS NOT AVAILABLE</p>	<p>VR-V2604</p> <p>*BSS Connections *Requires COM01 test adaptor for testing</p> <p>Replaces VALEO : 595365,2543535,591894,2543505,2591579...</p> <p>Unit No. BMW : 12317802261,12317802619,12317573754... VALEO : FG18S019,439613,440183,543461A,TG23C011...</p>
<p>PICTURE IS NOT AVAILABLE</p>	<p>VR-V2775</p> <p>Replaces VALEO : 2611164,593857,2542775</p> <p>Unit No. FIAT : 9646066880,9649611280 TOYOTA : 27060-YV020 VALEO : 2524924A,2542298A,2542693,2542726...</p>	<p>PICTURE IS NOT AVAILABLE</p>	<p>VR-V2775</p> <p>Replaces VALEO : 2611164,593857,2542775</p> <p>Unit No. FIAT : 9646066880,9649611280 TOYOTA : 27060-YV020 VALEO : 2524924A,2542298A,2542693,2542726...</p>

Brush Holder

Voltage Regulator

Repair Circuit

Rectifier

Diode Trio

Diode

Tester

VR-V2871

PICTURE
IS NOT
AVAILABLE

Replaces

VALEO : 2605904

Unit No.

VALEO : TG9S036

**VR-V2975**

*BSS 3 Connections

*Requires COM01 test adaptor for testing

*ID Code:48

Replaces

VALEO : 2542957,2580429,2580499,2591800,2608222...

Unit No.

VALEO : TG17C020,TG17C022,TG17C023,TG17C024...

VOLKSWAGEN : 06E903016D

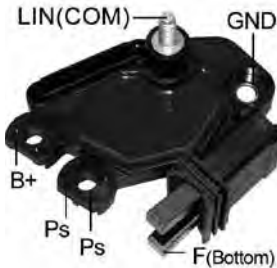
**VR-V2988**

* Voltage Set Point: 14.3V

* LIN

* 9600 & 19200 Baud Rate (4 Byte)

* ID Code: 169

Replaces

BMW : 12318515518

VALEO : 2612988,599212,599228

Unit No.

BMW : 12317823343,12317823344

VALEO : FG18S045,FG18D111,FG23S033

**VR-V3231**

*BSS 3 Connections

*Requires COM01 test adaptor for testing

*ID Code: 49

Replaces

VALEO : 2543231,593984,593877

Unit No.

BMW : 12317521178,12317525376,12317550968...

VALEO : 439560,TG17C015,2542720,TG17C016...

**VR-V3279**

* Voltage Set Point: 14.3V

* LIN-2

* 19200 Baud Rate (4 Byte)

* Requires COM01 test adaptor for testing

* ID Code: 33

Replaces

VALEO : 595243,593958,2543279,2542964,2580469,2591559

Unit No.

VALEO : TG17C028,TG17C030,TG17C030B,TG17C032...

**VR-V3406SE**

*Soft Start

*2.5 sec. LRC

*Short Circuit Protection

*Self Exciting

*Voltage Set Point: 14.4V

Replaces

VALEO : 593406,YR3634VFP2

Unit No.

VALEO : A14VI34,A14VI45,A14VI46,A14VI47

**VR-V3419**

*Soft Start

*2.5 sec. LRC

*Short Circuit Protection

*Voltage Set Point: 14.6V

Replaces

VALEO : 593419,2542549B

Unit No.

VALEO : A11VI106,A11VI108,A13VI276,A13VI277...

**VR-V3419SE**

*Self Exciting

*Soft Start

*2.5 sec. LRC

*Short Circuit Protection

*Voltage Set Point: 14.6V

Replaces

VALEO : 593419,2542549B

Unit No.

VALEO : A11VI106,A11VI108,A13VI276,A13VI277...



VR-V3530
 *Voltage Set Point: 14.3V
 *Soft Start
 *Short Circuit Protection
 *Regulated Voltage Control(RVC)
 *Requires RVC01 tester box for testing

Unit No.
 HYUNDAI : 37300-2E400
 VALEO : 2607372,2608483,2612741

PICTURE IS NOT AVAILABLE

VR-V3536
Replaces
 VALEO : 2609960,595464
Unit No.
 VALEO : FG23S010

PICTURE IS NOT AVAILABLE

VR-V3591
Replaces
 VALEO : 2543591,2610181,595318,599149
Unit No.
 BMW : 12-31-7-535-098,12-31-7-576-513...
 VALEO : TG12C059,TG12C061,TG12C120



VR-V3666
 *Soft Start
 *8.5 sec. LRC
 *Short Circuit Protection
 *Voltage Set Point: 14.6V

Replaces
 VALEO : 593666,YM1689PF,2549916B
Unit No.
 RENAULT : 7711134926,8200138269,8200290220
 VALEO : SG15L020,SG15L027,SG15L034,2542588...



VR-V3689
 *Soft Start
 *8.5 sec. LRC
 *Short Circuit Protection
 *Voltage Set Point: 14.6V
Replaces
 VALEO : 593689,YR1615PF,2603741,2542711
Unit No.
 VALEO : SG12B096,SG12B103,TG11C010,TG11C011...

PICTURE IS NOT AVAILABLE

VR-V3722
Replaces
 VALEO : 595332,599340
Unit No.
 VALEO : TG14C037

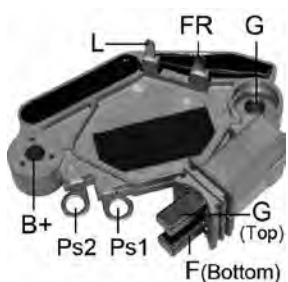

VR-V3779
 *Soft Start
 *8.5 sec. LRC
 *Short Circuit Protection
 *Voltage Set Point: 14.6V
Replaces
 VALEO : 593779,YM1693VFP,2542566
Unit No.
 VALEO : SG15L012,SG15L026



VR-V3780
 *BSS 2 Connections
 *Requires COM01 test adaptor for testing
 *ID Code: 56
Replaces
 VALEO : 593780,YR063,6D15,2610118,2542885,2543546...
Unit No.
 VALEO : SG12B062,A2711540902,2542582B



VR-V3788
 * B-Circuit
 * Voltage Set Point: 14.3V
 * LIN-1.3
 * 19200 Baud Rate (4 Byte)
Replaces
 VALEO : 595332,599119,599340
Unit No.
 VALEO : TG14C035,TG14C037,TG14C039,TG14C044...

PICTURE IS NOT AVAILABLE

VR-V3793
Replaces
 VALEO : 593793
Unit No.
 VALEO : TG15C038,2542852A,YLE500170

BSS  GND**VR-V3796**

*BSS Connections
*Requires COM01 test adaptor for testing

Replaces

VALEO : 593918,2543200,595265,599101,593796

Unit No.

VALEO : 2542611,2542613,2543304, TG17C010B...

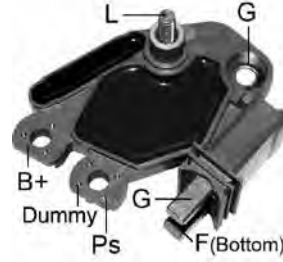
**VR-V3874**

*Soft Start
*2.5 sec. LRC
*Short Circuit Protection
*Voltage Set Point: 14.6V

Replaces

VALEO : 593874,593454,YM1666FP5

Unit No.

VALEO : SG9B037,SG9B038,SG9B039

PICTURE
IS NOT
AVAILABLE

VR-V3975**Replaces**

VALEO : 2604289,593975,595385

Unit No.

MERCEDES-BENZ : 2661540602,2661540902, A2661540602...

VALEO : TG11C074,TG11C021,TG11C035

**VR-V4114**

*BSS 3 Connections
*Requires COM01 test adaptor for testing
*ID Code: 44

Replaces

VALEO : 2604114

**VR-V4291**

* Voltage Set Point: 14.3V
* LIN-2
* 9600 & 19200 Baud Rate (4 Byte)
* Requires COM01 test adaptor for testing
* ID Code: 25

Replaces

FORD : 8V21-10300BB,9G9N-10300CA
MAZDA : Y406-18-300
VALEO : 593970,595393,599182,599194
VOLVO : 3600909,31285808

Unit No.

FORD : 8V21-10300AB,AV6N-10300MD,FG15T074
VALEO : TG12C038,2543427,TG15C121,TG15C103...

PICTURE
IS NOT
AVAILABLE

VR-V4803**Replaces**

VALEO : 595411

Unit No.

NISSAN : 23100-0027R,23100-4864R
RENAULT : 8200757870,8200849752
VALEO : TG12C062

**VR-V5001**

*Soft Start
*8.5 sec. LRC
*Short Circuit Protection
*Voltage Set Point: 14.6V

Replaces

VALEO : 2655001,20051012,2655479

Unit No.

HYUNDAI : 37300-37400,37300-37405,37300-3A002
KIA : QK2AA-18-300,RK2AA-18-300U
VALEO : 2655516,2655553,A0002655010,A0002655516...

**VR-V5120**

*Self Exciting
*Soft Start
*4.5 sec. LRC
*Short Circuit Protection
*Voltage Set Point:14.6V

Replaces

VALEO : 2605120,2542919,593993.







Unit No.

VALEO : TG9B024,TG7S010,TG7S011,TG9B025,2542920...

PICTURE
IS NOT
AVAILABLE

VR-V5339**Replaces**

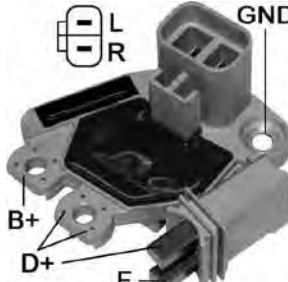
VALEO : 595339

<p style="text-align: center;">PICTURE IS NOT AVAILABLE</p>	<p>VR-V5366</p> <p>Replaces VALEO : 595366</p> <p>Unit No. VALEO : TG9B068,TG9B049,2607214A</p>	 <p>VR-V5428</p> <p>*Soft Start *2.5 sec. LRC *Short Circuit Protection *Voltage Set Point: 14.6V</p> <p>Replaces VALEO : 2655428</p> <p>Unit No. HYUNDAI : 37300-38400 VALEO : A0002655009</p>	<p style="writing-mode: vertical-rl; transform: rotate(180deg);">Brush Holder</p>
 <p>VR-V5460</p> <p>*Voltage Set Point: 13.8V *Soft Start *2.5 sec. LRC *Short Circuit Protection *Regulated Voltage Control(RVC) *Requires RVC01 tester box for testing</p>	<p>Replaces VALEO : 2605460,2616783</p> <p>Unit No. GM : 13500586 VALEO : TG12C070</p>	<p style="writing-mode: vertical-rl; transform: rotate(180deg);">Voltage Regulator</p>	
 <p>VR-V5633</p> <p>*IG-L Terminals *Voltage Set Point: 14.5V</p>	<p>Replaces VALEO : 2655633</p> <p>Unit No. HYUNDAI : 37300-03100</p>		<p style="writing-mode: vertical-rl; transform: rotate(180deg);">Repair Circuit</p>
 <p>VR-V5745</p> <p>*Soft Start *2.5 sec. LRC *Short Circuit Protection *Voltage Set Point:14.5V</p>	<p>Replaces VALEO : 20050526,20080710,133421122</p> <p>Unit No. HYUNDAI : 37300-25201,37300-23650 VALEO : TG11C076,2655635,A0002655635</p>	<p style="writing-mode: vertical-rl; transform: rotate(180deg);">Rectifier</p>	
<p style="text-align: center;">PICTURE IS NOT AVAILABLE</p>	<p>VR-V5904</p> <p>Replaces VALEO : 2605904,595389</p> <p>Unit No. VALEO : TG9S037,TG9S014, TG9S036,TG9S039,TG9S040...</p>		 <p>VR-V6131</p> <p>*Voltage Set Point: 14.5V</p> <p>Replaces VALEO : 13480351</p> <p>Unit No. HYUNDAI : 37300-02550, 37300-02551,37300-02570...</p>
<p style="text-align: center;">PICTURE IS NOT AVAILABLE</p>	<p>VR-V7052</p> <p>Unit No. HYUNDAI : 37300-02600 VALEO : 2607052</p>	 <p>VR-V7059</p> <p>* Voltage Set Point: 14.3V * LIN * 9600 & 19200 Baud Rate (4 Byte)</p> <p>Replaces VALEO : 595291,599171,599296,2617059</p> <p>Unit No. VALEO : TG23C019</p>	<p style="writing-mode: vertical-rl; transform: rotate(180deg);">Diode</p>
		<p style="writing-mode: vertical-rl; transform: rotate(180deg);">Tester</p>	

PICTURE
IS NOT
AVAILABLE

VR-V7131

- *Soft Start
- *13 sec. LRC
- *Short Circuit Protection
- *Voltage Set Point: 14.2V

Replaces

VALEO : 2607131

Unit No.

TOYOTA : 27060-0T230
VALEO : FG12T050

**VR-V7144**

- * Voltage Set Point: 14.0V
- * Regulated Voltage Control(RVC)

Replaces

VALEO : 2607144

Unit No.

VALEO : FG15S024,FG15S090

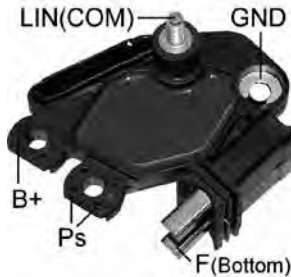
**VR-V7319**

- *B-Circuit
- *Voltage Set Point: 13.8V
- *LIN-1
- *9600 & 19200 Baud Rate (4 Byte)
- *Requires COM01 test adaptor for testing

Replaces

VALEO : 2612671,2621055

Unit No.

FORD : 1685793,1704769,AV6N-10300GB,AV6NGB...
LUCAS : LRA03470,LRA3470
VALEO : TG15C169,TG15C183,TG15C174,2610695B

**VR-V8052**

- *Voltage Set Point: 14.3V
- *LIN
- *19200&9600 Baud Rate (4 Byte)
- *Requires COM01 test adaptor for testing
- *ID Code: 25

Replaces

VALEO : 2618052,599233

Unit No.

VALEO : TG14C041,TG14C018,TG14C020,TG14C043...
VOLKSWAGEN : 06J-903-023H

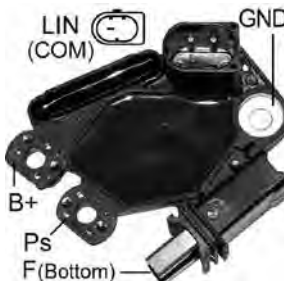
**VR-V8054**

- *Voltage Set Point: 14.3V
- *LIN
- *9600 & 19200 Baud Rate (4 Byte)
- *Requires COM01 test adaptor for testing
- *ID Code: 33

Replaces

VALEO : 2618054M,2618054B

Unit No.

AUDI : 06H-903-016S

**VR-V8060**

- *Voltage Set Point: 14.3V
- * LIN-1
- * 9600 & 19200 Baud Rate (4 Byte)
- *Requires COM01 test adaptor for testing

Replaces

VALEO : 2618060B,599237

Unit No.

VALEO : SVES082639,FG20S015,FG20S016,FG20S017...
VOLKSWAGEN : 06H 903 017K,03L 903 017B,440435...

**VR-V8237**

- *BSS 2 connections
- *Requires COM01 test adaptor for testing
- *ID Code: 44

Replaces

VALEO : 595253,595252,595379

Unit No.

VALEO : TG11C041,TG11C055,
TG11C060,TG11C066...

**VR-V8326**



- *Soft Start
- *Short Circuit Protection
- *Voltage Set Point: 14.5V

Replaces

VALEO : 2608326

Unit No.

KIA : 37300-2B101
VALEO : 2655447

 <p>VR-V8417 *L-Dummy Terminals *Soft Start *6 sec. LRC *Short Circuit Protection *Voltage Set Point: 14.5V</p> <p>Replaces VALEO : 2608417A Unit No. HYUNDAI : 37300-2A110</p>	<p>VR-V8689</p> <p>Replaces VALEO : 2618689 Unit No. VALEO : TG12C124,TG12C149,TG12C152 NISSAN : 23100-4BA0A, 23100-4BB0B,23100-7865R</p>
<p>PICTURE IS NOT AVAILABLE</p> <p>VR-V9446</p> <p>Unit No. MERCEDES-BENZ : A0009062822 VALEO : CG20U011</p>	
 <p>VR-V9938 *Soft Start *Short Circuit Protection *Voltage Set Point: 14.3V *Regulated Voltage Control(RVC) *Requires RVC01 tester box for testing</p> <p>Replaces VALEO : 2609938 Unit No. HYUNDAI : 37300-2G150,37300-2G600</p>	

Brush Holder

Voltage Regulator

Repair Circuit

Rectifier

Diode Trio

Diode

Tester

**VR-DU509**

*Voltage Set Point:15.5V

Replaces

BOSCH : 0-190-601-014,9-190-110-539
FEMSA : GRO12-10,GRO12-12,GRO12-7
LUCAS : 21930022,37696,NCB203,NCB212
PEUGEOT : 5761.28,5761.29,5761.31
PORSCHE : 91160390100
SEV MARCHAL : 33505,33523,71270402,72711202,72711502
TALBOT : 15224800,15224891,30201E,373994J,461138S
VALEO : 505046,77616,79905,NB973,NC334
VALEO(DUCELLIER) : 519004,8358,8367,8373,8380
VALEO(MOTOROLA) : 9RH7014
VALEO(PARIS RHONE) : AYA2114,AYB214,AYB216,YL142
VOLVO : 6877982

Unit No.

VALEO : 2074684,2077791,2093051,2093073,2095084...

**VR-DU510**

*Voltage Set Point:14.5V

Replaces

BOSCH : 9-190-110-031,9-190-110-034,9-190-110-041
CITROEN : 5491551,AK5351
FEMSA : GRK12-13,GRK12-2,GRK12X-1,GRO12-2,GRO12X-1...
ISKRA : 11-125-109,AER3006
LUCAS : 21930021,21931006,37175,37695,NCB201,NCB209...
MAGNETI MARELLI : 64800002
PEUGEOT : 5761.23,5761.24,5761.32,5761.33,5835.02
RENAULT : 7700519493,7700530749,7700544686...
SEV MARCHAL : 33036,33067,33081,33506,33518,33519...
TALBOT : 163009,42290B,55822700
VALEO : 100065,100207,505045,505048,505049,70335...
VALEO(DUCELLIER) : 510002,510004,510005,519001,8320...
VALEO(MOTOROLA) : 9RH7013,9RH7016,9RH7017
VALEO(PARIS RHONE) : AY21,AY21T,AYA21,AYA210,AYA213...
VOLVO/DAF : 01215477,01215565,114374,1259303,215565...

Unit No.

VALEO : 2074684,2077791,2093051,2093073,2095084...
VALEO(DUCELLIER) : 512001,513001,513002,513003,513004...
VALEO(MOTOROLA) : 510-064,510-079,510-157,9AL2572K...
VALEO(PARIS RHONE) : A13N100,A13N102,A13N135,A13R115,A1

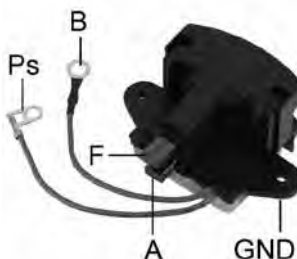
**VR-DU511**

*Voltage Set Point:14.5V

Replaces

CITROEN : 95546007
DELCO REMY (LUCAS) : 21220353
LUCAS : 21220253,UCB206,UCB207
RENAULT : 7701024524,7701027713,7701030069
VALEO : NB982
VALEO(DUCELLIER) : 511006,511008,511010,511022...

Unit No.

VALEO(DUCELLIER) : 512008,512010,514011,514012,516006...

**VR-DU512**

*Voltage Set Point:14.5V

Replaces

LUCAS : 21220371,UCB227
MAGNETI MARELLI : 940038047
PEUGEOT : 5761.48,5761.49,5761.61
VALEO : NB926,NB928
VALEO(DUCELLIER) : 511015,511023,581257,582991...

Unit No.

VALEO(DUCELLIER) : 514005,514007CDE,514010BC,516032,5160



VR-DU513
 *For use on:Renault
 *Voltage Set Point:14.5V

Replaces
 LUCAS : 21220379,UCB235
 VALEO : NB987
 VALEO(DUCELLIER) : 511018,691191
Unit No.
 RENAULT : 7700670275
 VALEO(DUCELLIER) : 516008,516035A,516035B



VR-DU514
 *Voltage Set Point:14.7V

Replaces
 VALEO : NB985,NB986
 VALEO(DUCELLIER) : 511015,691146,691170
Unit No.
 VALEO(DUCELLIER) : 516002,516019,516027



VR-DU515
 *Voltage Set Point:14.7V

Replaces
 DELCO REMY (LUCAS) : 21220383
 VALEO : NB988
 VALEO(DUCELLIER) : 511015
Unit No.
 VALEO(DUCELLIER) : 516041

Brush Holder

Voltage Regulator

Repair Circuit

Rectifier

Diode Trio

Diode

Tester

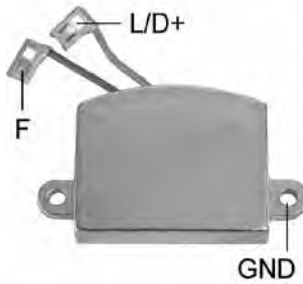
**VR-VW002**

*Voltage Set Point:14.5V

Replaces

AUDI/VW : 171903803,55903803,55903804

FORD : 6048270,77BB-10316AA

LUCAS : 21029141,21229047,21229114,21229491,UCB500

PEUGEOT : 5761.39

VALEO : 505001,505003,505005,505008,505009,505010...

VALEO(MOTOROLA) : 9RC2003,9RC2006,9RC7002,9RC7003...

Unit No.

VALEO(MOTOROLA) : 10-763,10-764,10-765,10-766,10-767...

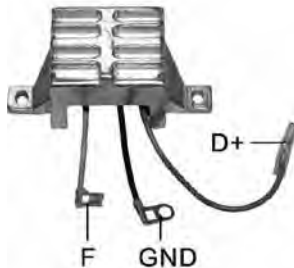
**VR-VW003**

*Voltage Set Point:14.5V

Replaces

AUDI/VW : 36903803

FORD : 6073340,80BB-10316AA

LUCAS : 21229048,21229142,UCB501

VALEO : 505019,505020,505031,505032,505069,505072...

VALEO(MOTOROLA) : 9RC7024,9RC7025,9RC7041,9RC7042...

Unit No.

VALEO(MOTOROLA) : 9AR2683G,9AR2687G,9AR2697D,9AR2698F

**VR-VW005N**

*Voltage Set Point:14.5V

Replaces

AUDI/VW : 026903015E,036903803A,037903803,049903803H

CHRYSLER : 2940030

LUCAS : 21229199,UCB506

MAGNETI MARELLI : 940038151

VALEO : 2519124,2521766,2522098,2522939,2523198...

VALEO(DUCELLIER) : 592989,505-100,505-105,592806

VALEO(MOTOROLA) : 2940022,2940030,2940305,2940305A...

Unit No.

AUDI/VW : 026903015E

MITSUBISHI MOTORS : 9AR2973L

VALEO : 026903015EV,026903015EX,026903015EY...

VALEO(MOTOROLA) : 2940302,2940304,2940305,2940306,294030

VALEO(PARIS RHONE) : A14V01,A14V02,A14V03,A14V04,A14V05

**VR-VW005NH**

*Heavy Duty for Max.140A Alternators.

*Voltage Set Point:14.5V

VR-VW006

*24V

*Adjustable Voltage

*Voltage Set

Point:26.6V~30.0V

Replaces

VALEO(MOTOROLA) : 105246,8RL3011

Unit No.

VALEO(MOTOROLA) : 10-298,8SC3014U

Replaces

VALEO(MOTOROLA) : 105229,8RL3007

Unit No.

VALEO(MOTOROLA) : 10-258

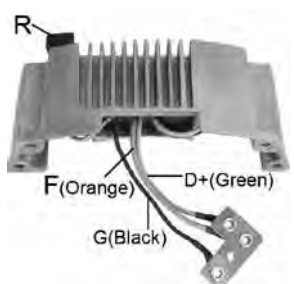
**VR-VW007**

*24V

*Adjustable Voltage

*Voltage Set

Point:26.6V~30.0V

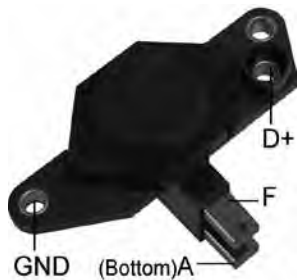

VR-VW009
*Voltage Set Point:14.5V

Replaces

MERCEDES-BENZ : 1500255
VALEO : 2518044,592792,YV0913H
VALEO(MOTOROLA) : 2541141

Unit No.

MERCEDES-BENZ : 008-154-6708,008-154-8702,008-154-8902
VALEO : 2518044,2518046,2541297
VALEO(PARIS RHONE) : A13V02,A13V05,A13V07



VR-VW010
*Voltage Set Point:14.7V

Replaces

AUDI/VW : 028903803F,078903803A,078903803B
LUCAS : 2131049,UCB245
MAGNETI MARELLI : 940038186,943356220,943356220010
MERCEDES-BENZ : 21549106
PEUGEOT : 5761.87,5761.9
VALEO : 2521335,2541392,2541404,2541433,2541493...
VALEO(MOTOROLA) : 9RC2054,9RC6065
VOLKSWAGEN : 028903803F,078903803A,078903803B

Unit No.

AUDI/VW : 030903023AA,030903023EV,030903023EX...
DAIMLER-BENZ : 0091545902,91545902
VALEO : 2541246,2541299,2541321,2541348,2541355...
VALEO(PARIS RHONE) : A11VI10,A11VI11,A11VI17,A11VI18...

**VR-PR002H**

- *Soft Start
- *2.5 sec. LRC
- *Short Circuit Protection
- *Voltage Set Point:14.6V

Replaces

VALEO : 593290,593310,593349
VALEO(PARIS RHONE) : YM1600

Unit No.

VALEO(PARIS RHONE) : A11VI165,A11VI184,
A11VI209,A11VI212..

**VR-PR003H**

- *Soft Start
- *8.5 sec. LRC
- *Short Circuit Protection
- *Voltage Set Point:14.6V

Replaces

VALEO : 593319
VALEO(PARIS RHONE) : YM1919P1

Unit No.

VALEO(PARIS RHONE) : A13VI178,A13VI202,
A13VI237,A13VI257

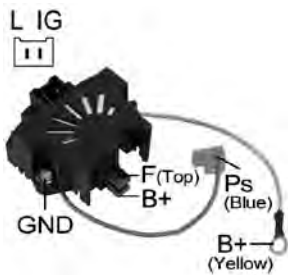
**VR-PR1000H**

- *Voltage Set Point:14.5V

Replaces

ISKRA : 11-125-113,AER1521
LUCAS : 21225345,UCB218,UCB223,NCB218
MAGNETI MARELLI : 940038162
RENAULT : 7701028400,7701029095,7701031737...
SEV MARCHAL : 71490602,72590602,72590702,72591202
VALEO : 182046,2590588,300668,300795,300806,300868...
VALEO(PARIS RHONE) : YH1649,YH1652,YH1654,YL122...

Unit No.

SEV MARCHAL : 71651902,71652402,71652602
VALEO(PARIS RHONE) : A13N104,A13N106,
A13N107,A13N108,A1

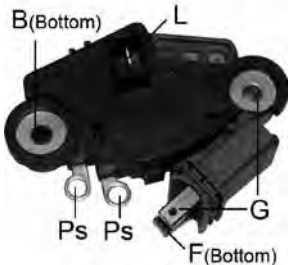
**VR-PR1060H**

- *Soft Start
- *8.5 sec. LRC
- *Short Circuit Protection
- *Voltage Set Point:14.2V

Replaces

VALEO : 593305,593318
VALEO(PARIS RHONE) : YM10607P,YM1606P1,YV1060P

Unit No.

VALEO(PARIS RHONE) : A13VI151

**VR-PR123**

- *Voltage Set Point:14.5V

Replaces

LUCAS : 21225423
VALEO : 300669,92867
VALEO(PARIS RHONE) :
YL123,YL123B,YL134,YL143

Unit No.

VALEO(PARIS RHONE) :
2098216,2098482,2102159,
2102160,A12M

VR-PR124

- *To be replaced by VR-PR2000H
- *Voltage Set Point:14.5V

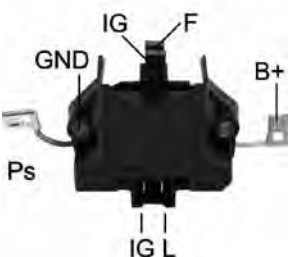
**VR-PR126**







- *Voltage Set Point:14.5V

Replaces

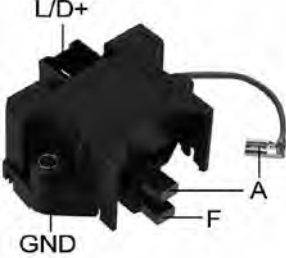
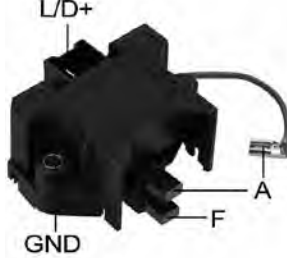
DELCO REMY (LUCAS) : 21225422
RENAULT : 7701030814
VALEO : 182005,182011,2590558,300725,300883,590660...
VALEO(PARIS RHONE) : YH1639,YH2602,YH2605,YH2606...

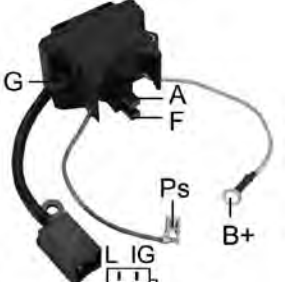
Unit No.

VALEO(PARIS RHONE) : A13N10,A13N43,A13N69,
A13N76,A13N92

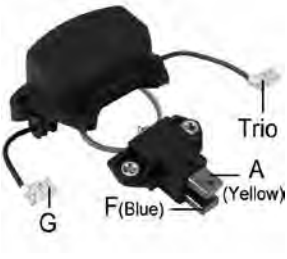
 <p>VR-PR127B *24V *Voltage Set Point:28.3V</p> <p>Replaces PEUGEOT : 5761.51 VALEO : 92955,NC692 VALEO(PARIS RHONE) : ZL127</p> <p>Unit No. VALEO(PARIS RHONE) : A12R35T,A14R341T, A14R34T,A14R541T</p>	 <p>VR-PR128 *Voltage Set Point:14.5V</p> <p>Replaces VALEO : 182007,182013,300663, 300685,92991 VALEO(PARIS RHONE) : YH190 3,YH1928,YL128,YL137,YL145...</p> <p>Unit No. VALEO(PARIS RHONE) : A13N165,A13N21T, A13N26,A13N34,A13N</p>
 <p>VR-PR128B *24V *Voltage Set Point:28.3V</p>	<p>Replaces LUCAS : UCB237 VALEO : 590640,92901,92962,A541184A,NC171,092962Y... VALEO(PARIS RHONE) : ZL126,ZL128,ZV3928</p> <p>Unit No. VALEO(PARIS RHONE) : A13N11,A13N174, A13N190,A13N22T,A13</p>
 <p>VR-PR130 *Voltage Set Point:14.5V</p>	<p>Replaces SEV MARCHAL : 72591502 VALEO : 300667,300675,300676,92918,92930,92933 VALEO(PARIS RHONE) : YL130,YL131,YL136,YL140,YL141...</p> <p>Unit No. VALEO(PARIS RHONE) : A12R38,A12R46,A14N1, A14N2,A14R35,A</p>
 <p>VR-PR132B *24V *Voltage Set Point:28.3V</p>	<p>Replaces VALEO : 182008,2590537 VALEO(PARIS RHONE) : YV3932,ZL132,ZL134,ZV3932</p> <p>Unit No. VALEO : 2101823,2181757,2181758,2181759,2181760... VALEO(PARIS RHONE) : A13N140T,A13N141T, A13N142T,A13N256</p>
 <p>VR-PR135 *Voltage Set Point:14.5V</p>	<p>Replaces LUCAS : UCB243 VALEO : 2590512,300692,300741,92966,NC362,NC927... VALEO(PARIS RHONE) : YL135,YL146,YL147</p> <p>Unit No. VALEO(PARIS RHONE) : A13N28M,A14N48M,A14N66M</p>
 <p>VR-PR135B *24V *Voltage Set Point:28.3V</p> <p>Replaces LUCAS : 21225372,UCB239 VALEO : 300744,NC184 VALEO(PARIS RHONE) : ZL129</p> <p>Unit No. VALEO(PARIS RHONE) : A13N143M,A13N152M, A13N36M,A13N56</p>	 <p>VR-PR135BA *24V *Adjustable Voltage *Voltage Set Point:25.0~30.0V</p> <p>Replaces LUCAS : 21225372,UCB239 VALEO : 300744,NC184 VALEO(PARIS RHONE) : ZL129</p> <p>Unit No. VALEO(PARIS RHONE) : A13N33M,A13N36M, A13N59M,A14N122M</p>

**VR-PR1424H**

*Voltage Set Point:14.6V
*w/o Choke

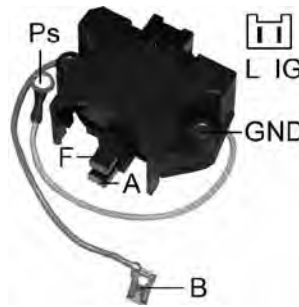
**VR-PR152A**

*To be Replaced by VR-PR1652/PR-1652H
*Voltage Set Point:14.5V

Brush Holder

Voltage Regulator

**VR-PR1620H**

*W/ Choke
*Voltage Set Point:14.6V

Replaces

VALEO : 593316,593338 ,593411 ,9RC7108 ,YM1424P1 ...

Unit No.

VALEO(PARIS RHONE) : 2541946,2541947,2541953,2541954,2541

Repair Circuit

**VR-PR1667**

*Voltage Set Point:14.7V

Replaces

VALEO : 2541406,2541496,592793,9RC2055,9RC2062...

VALEO(PARIS RHONE) : YV1667H

Unit No.

VALEO(PARIS RHONE) : A11VI28,A11VI31,A13VI21,A13VI11,A13V

Rectifier

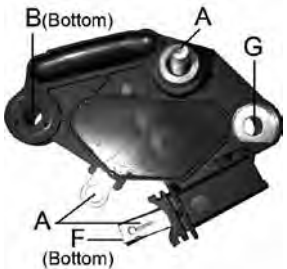
**VR-PR1669**

*Voltage Set Point:14.7V

Replaces

VALEO : 2541715,2541715B,2808323,5931138,NF076...

VALEO(MOTOROLA) : 9RC6074

VALEO(PARIS RHONE) : YM6951

Unit No.

VALEO : 2541678,2541679,A13V172,A13V173

Diode Trio

**VR-PR1671**

*Voltage Set Point:14.2V

Replaces

VALEO : 593132,593140

VALEO(PARIS RHONE) : YV10673H,YV3670

Unit No.

VALEO : 2541678,2541679,A13V172,A13V173

Diode

Tester

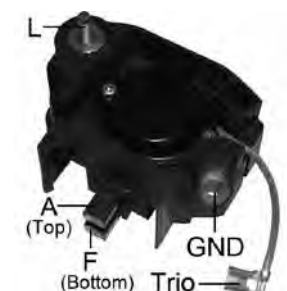
**VR-PR1926**

*Voltage Set Point:14.7V

Replaces

CITROEN : 9405761798

VALEO : 2541192,2541193,590688,9RC2047,YV1926

VALEO(PARIS RHONE) : YV1926T

Unit No.

VALEO(PARIS RHONE) : A13N184,A14N139,A14N172

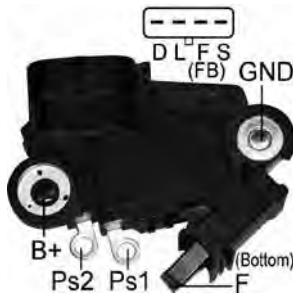
**VR-PR1935**

- *Soft Start
- *8.5 sec. LRC
- *Short Circuit Protection
- *Voltage Set Point:14.8V

Replaces

VALEO : 593342,2541935B

Unit No.

GM : 10246634

VALEO : 2542445A,A14VI21,A14VI39

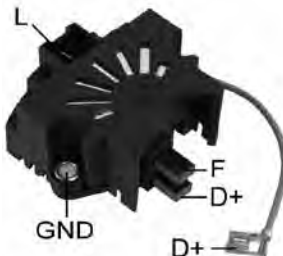
**VR-PR2000H**

- *Voltage Set Point:14.5V

Replaces

LUCAS : 21225183,UCB220

MAGNETI MARELLI : 940038161

PEUGEOT : 5761.56

SEV MARCHAL : 72590902

VALEO : 182120,2590538,2590542,300820,300830,300884...

VALEO(PARIS RHONE) : YH1925,YH1933,YH2701,YH2925...

VOLVO : 3343913

Unit No.

VALEO(PARIS RHONE) : A12R22,A12R33,A12R52,

A13N32,A13N39

**VR-PR2206**

- *Soft Start
- *3 Sec. LRC
- *Short Circuit Protection
- *Voltage Set Point:14.6V

Replaces

VALEO : 2543327B,595211

Unit No.

BOSCH : 0-986-045-031

VALEO : 2542812A,2542826A,2542812,2542826...

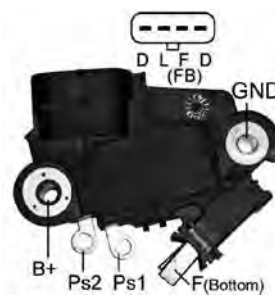
**VR-PR2222**

- *Soft Start
- *8.5 sec. LRC
- *Short Circuit Protection
- *Voltage Set Point:14.8V

Replaces

VALEO : 2542222B

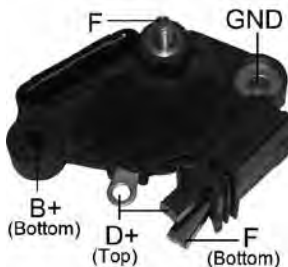
**VR-PR2288**

- *Voltage Set Point:14.7V

Replaces

VALEO : 2542288,593375

VALEO(PARIS RHONE) : YM6956

**VR-PR2292H**

- *B-Circuit
- *Soft Start
- *2.5 sec. LRC
- *Short Circuit Protection
- *Voltage Set Point:14.7V

Replaces

AUDI : 06B903803,06B903803A,06B903803B,078903803C

VALEO : 593455,593941,593371,593455,593480,593522...

VALEO(PARIS RHONE) : YM1672,YM1626F

Unit No.

VALEO : 2542234,2542227,2542233C,2542324,437173...

VALEO(PARIS RHONE) : SG12B010,SG12B011,

SG12B015,SG12B0

VOLKSWAGEN : 06J-903-023C,03C-903-025D,03C-903-023B

**VR-PR2293**

- *B-Circuit
- *Soft Start
- *2.5 sec. LRC
- *Short Circuit Protection
- *Plug is different from VR-PR2292H
- *Voltage Set Point:14.6V

Replaces

VALEO : 593943

Unit No.

VALEO : SG12B024

**VR-PR2299H**

- *Voltage Set Point:14.6V

Replaces

VALEO : 2542299,593384,593396,YM1636P1

Unit No.

VALEO : 2542270,2542466

VALEO(PARIS RHONE) :

SG10B010,SG10B011,

SG10B016 ,SG10B

**VR-PR2339**

- *Soft Start
- *8.5 sec. LRC
- *Short Circuit Protection
- *Voltage Set Point:14.8V

Replaces

VALEO : 2542339B

Unit No.

VALEO : A14VI63,SA14VI63

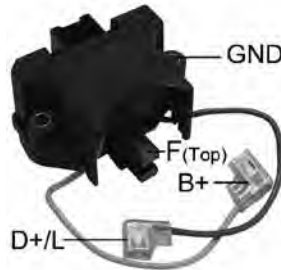
**VR-PR2700**

- *Voltage Set Point:14.6V

Replaces

PORSCHE : 91160391301,92860320700
 VALEO : 092991,300871,YH2700,YV2700
 VALEO(PARIS RHONE) : YH 2700

Unit No.

VALEO : 2101368,2102746,2104355,2104905
 VALEO(PARIS RHONE) : A14N38,A14N67,A14N71

**VR-PR2765**

- *B-Circuit
- *Soft Start
- *2.5 sec. LRC
- *Short Circuit Protected
- *Voltage Set Point:14.6V

Replaces

VALEO : 2542765,2542765C,2548154E,2601726,2650490

Unit No.

VALEO : 2542454A,SG12S057,SG12S075,SG12S083...

**VR-PR3389**

- *B-Circuit
- *Inactive Lamp
- *Soft Start
- *8 sec. LRC
- *Short Circuit Protection
- *Voltage Set Point:14.6V

Replaces

VALEO : 593389,593818,2542213,2548923

Unit No.

HYUNDAI : 37300-37250
 VALEO : 439295

**VR-PR3430**

- *24V
- *Voltage Set Point:28.3V

Replaces

VALEO : 2542419,593430
 VALEO(PARIS RHONE) : ZV3963T

Unit No.

VALEO : 2542433,2542479,2542493
 VALEO(PARIS RHONE) : HD90S013,HD90S014,HD90S015

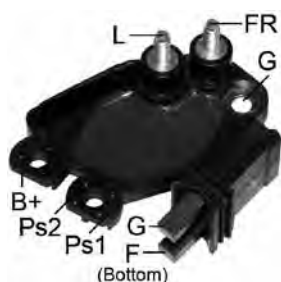
**VR-PR3529**

- *Soft Start
- *2.5 sec LRC
- *Short Circuit Protection
- *Self Exciting
- *Voltage Set Point:14.6V

Replaces

VALEO : 593529

Unit No.

VALEO : 2542485A,9642879480

**VR-PR3534**

- *Soft Start
- *2.5 sec LRC
- *Short Circuit Protection
- *Voltage Set Point:14.6V

Replaces

VALEO : 593477,593505,593534,YR 6604,YR66P,2542934

Unit No.

VALEO : 2542414A,2542489,254 2489A,2542564...

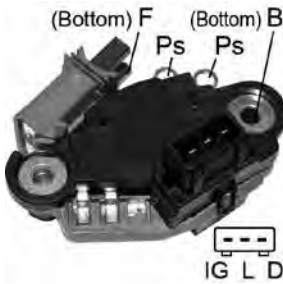
**VR-PR3617H**

*Voltage Set Point:14.5V

ReplacesVALEO : 2542204,593333,2542209B,593347,593391
VALEO(PARIS RHONE) : YM3617PIC,YM2618P1**Unit No.**

VALEO(PARIS RHONE) : A13VI150,A13VI160

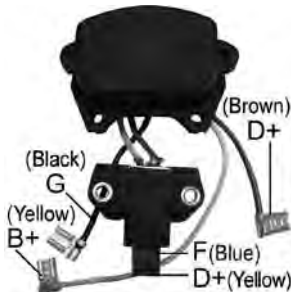
**VR-PR3729A***24V
*Voltage Set Point: 27.8V+/-
0.3V
*Adjustable Voltage**Replaces**MAGNETI MARELLI : 940038173
VALEO : 590536
VALEO(PARIS RHONE) : A14N100M,A14N119M,A14N122M...**Unit No.**

VALEO : 2102052,2180619,2180620,2181991,2541168...

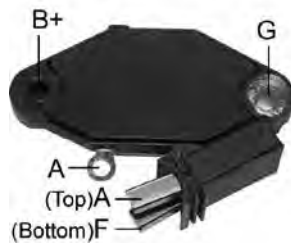
**VR-PR3960***24V
*Voltage Set Point:28.3V**Replaces**VALEO : 593260
VALEO(PARIS RHONE) : ZV3960H**Unit No.**

VALEO(PARIS RHONE) : A14VI19

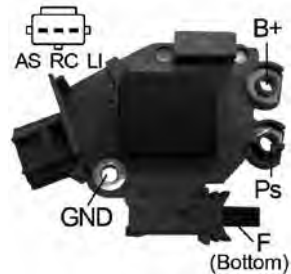
**VR-PR4920***Voltage Set Point:14.2V(RC
50% duty cycle)
*Voltage Set Point: 14.0V
*Regulated Voltage
Control(RVC)
*Requires RVC01 tester box
for testing**Replaces**VALEO : 2604920
VALEO(PARIS RHONE) : 593675,YH0601,599121,599123**Unit No.**

VALEO(PARIS RHONE) : SG15S019,TG12C013,TG9C013

**VR-PR5011***B-Circuit
*Inactive Lamp
*Soft Start
*8 sec. LRC
*Short Circuit Protection
*Voltage Set Point:14.5V**Replaces**

VALEO : 20071017,20080622

Unit No.HYUNDAI : 37300-39400,37300-39435,37300-39450
VALEO(PARIS RHONE) : A0002655011,
A0002655045,A0002655438**VR-PR5023***B-Circuit
*Inactive Lamp
*Short Circuit Protection
*Voltage Set Point:14.5V**Replaces**HYUNDAI : 37370-22650
VALEO : 2607089**Unit No.**HYUNDAI : 37300-22650
VALEO : A0002655023,2655023

Brush Holder

Voltage Regulator

Repair Circuit

Rectifier

Diode Trio

Diode

Tester

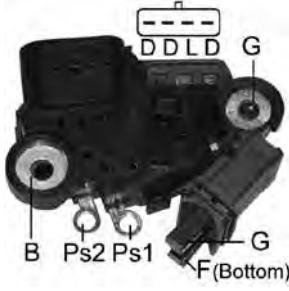

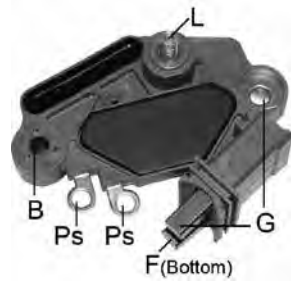

VR-PR6366
 *Voltage Set Point:14.6V
 *Soft Start
 *8.5 Second LRC
 *Short Circuit Protected
Replaces
 VALEO : 2546366C,2546493C
Unit No.
 DELCO : 10295859
 VALEO : 439218
 VALEO(PARIS RHONE) :
 A13VI147,A13VI194

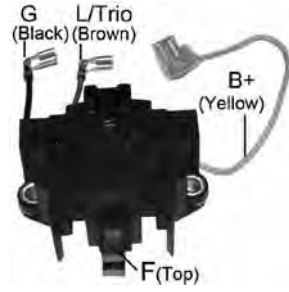

VR-PR6603H
 *Soft Start
 *2.5 sec. LRC
 *Short Circuit Protected
 *Voltage Set Point:14.6V
Replaces
 VALEO : 593284
Unit No.
 VALEO : 2542500

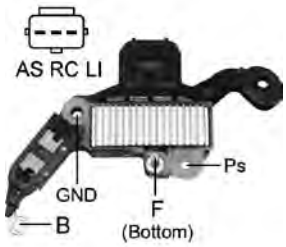

VR-PR7736
 *Voltage Set Point:14.5V
Replaces
 VALEO : 593135
 VALEO(PARIS RHONE) : YV7736
Unit No.
 VALEO(PARIS RHONE) :
 A13N234,A13N259,A13N285

 <p>VR-VN001 *A-Circuit *Voltage Set Point:14.0V *Regulated Voltage Control(RVC) *Requires RVC01 tester box for testing</p> <p>Unit No. FORD : 1S7T-10300BA, 1S7T-10300BB,1S7T-10300BC VISTEON : 20-150-01005</p>	 <p>VR-VN002 *A-Circuit *S-D-L Terminals *Soft Start *Short Circuit Protection *Voltage Set Point:14.5V</p> <p>Unit No. FORD : 2S6T-10300FA, 3N21-10300BB,XS611-0300BD...</p>
 <p>VR-VN005 *Soft Start *Short Circuit Protection *Voltage Set Point: 14.5V</p> <p>Replaces FORD : BF0A-10376AA</p> <p>Unit No. VISTEON : 20-150-01011</p>	

- Brush Holder
- Voltage Regulator
- Repair Circuit
- Rectifier
- Diode Trio
- Diode
- Tester

Brush Holder

Voltage Regulator

Repair Circuit

Rectifier

Diode Trio

Diode

Tester

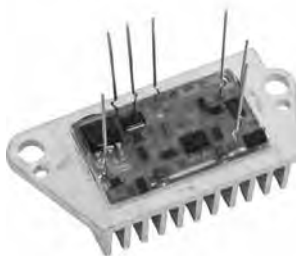

VR-H2005-10S
 *Repairs:
 *VR-H2005-10
 *Voltage Set Point:14.4V



VR-H2005-15S
 *Repairs:
 *VR-H2005-15H
 *VR-H2005-24
 *Voltage Set Point: 14.4V

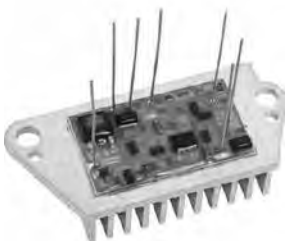

VR-H2005-22S
 *Repairs:
 *VR-H2005-22
 *VR-H2005-40
 *Voltage Set Point:14.6V

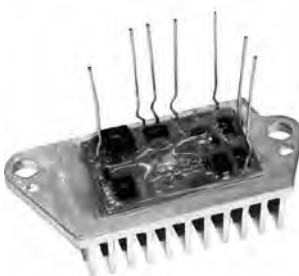

VR-H2005-23AS
 *Repairs:
 *VR-H2005-23A
 *Voltage Set Point:14.6V



VR-H2005-25S
 *Repairs:
 *VR-H2005-25
 *Voltage Set Point:14.4V



VR-H2005-26AS
 *Repairs:
 *VR-H2005-26A
 *VR-H2005-39
 *Voltage Set Point:14.6V

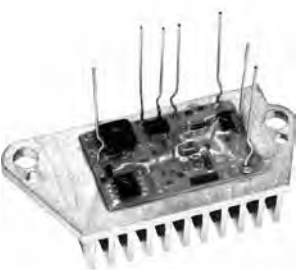

VR-H2005-33AS
 *Repairs:
 *VR-H2005-33A
 *VR-H2005-46A
 *Voltage Set Point:14.6V



VR-H2005-3S
 *Repairs:
 *VR-H2005-3
 *VR-H2005-28
 *VR-H2005-29
 *Voltage Set Point:14.5V



VR-H2005-4AS
 *Repairs:
 *VR-H2005-4A
 *VR-H2005-45A
 *Voltage Set Point:14.6V



VR-H2005-5S
 *Repairs:
 *VR-H2005-5H
 *VR-H2005-14H
 *VR-H2005-16
 *VR-H2005-47
 *Voltage Set Point:14.4V



VR-H2005-62AS
 *Repairs:
 *VR-H2005-62A
 *Voltage Set Point:14.6V



VR-H2005-6S
 *Repairs:
 *VR-H2005-6H
 *Voltage Set Point:14.4V

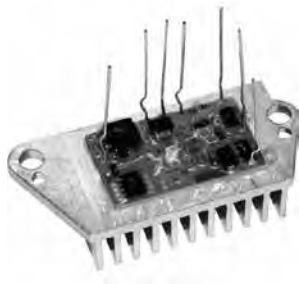

VR-H2005-9AS

- *Repairs:
- *VR-H2005-9A
- *Voltage Set Point:14.6V

- Brush Holder
- Voltage Regulator
- Repair Circuit**
- Rectifier
- Diode Trio
- Diode
- Tester



VR-H2000-13S
 *Repairs:
 *VR-H2000-6H
 *VR-H2000-13
 *Voltage Set Point:14.5V



VR-H2000-14S
 *Repairs:
 *VR-H2000-14
 *Voltage Set Point:14.5V

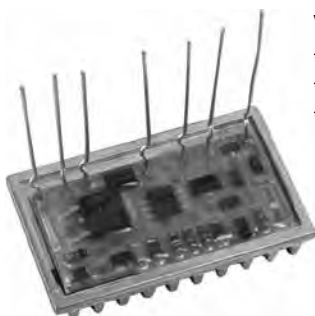

VR-H2000-15S
 *Repairs:
 *VR-H2000-15
 *Voltage Set Point:14.5V



VR-H2000-18S
 *VR-H2000-18
 *Voltage Set Point:14.5V



VR-H2000-23S
 *Reparis:
 *VR-H2000-23
 *VR-H2000-16
 *Voltage Set Point:14.5V



VR-H2000-28S
 *Repairs:
 *VR-H2000-27
 *VR-H2000-28
 *Voltage Set Point:14.5V

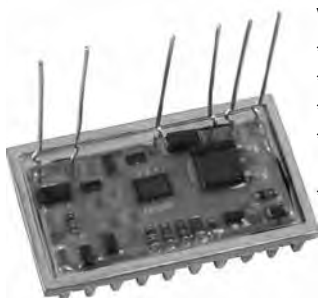

VR-H2000-38S
 *Repairs:
 *VR-H2000-38
 *Voltage Set Point:14.5V
 *W/o Overvoltage/
 Undervoltage indication
 *W/o Short Circuit Protection



VR-H2000-41S
 *Repairs:
 *VR-H2000-41



VR-H2000-44S
 *Repairs:
 *VR-H2000-44
 *Voltage Set Point:14.5V



VR-H2000-46S
 *Repairs:
 *VR-H2000-46
 *Voltage Set Point:14.5V



VR-H2000-48S
 *Repairs:
 *VR-H2000-48

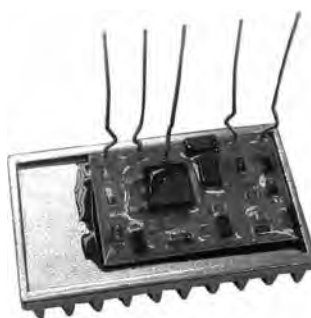

VR-H2000-52S
 *Repairs:
 *VR-H2000-52
 *Voltage Set Point:14.3V

Brush Holder

Voltage Regulator





Repair Circuit

Rectifier

Diode Trio

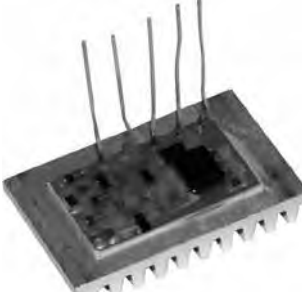
Diode

Tester

 <p>VR-H2000-55BS *Repairs: *VR-H2000-55 *Voltage Set Point:28.5V</p>	 <p>VR-H2000-57S *Repairs: *VR-H2000-57 *Voltage Set Point:14.3V</p>
 <p>VR-H2000-5S *Repairs: *VR-H2000-5H</p>	 <p>VR-H2000-9S *Repairs: *VR-H2000-9 *VR-H2000-12 *VR-H2000-65 *Voltage Set Point:14.5V</p>

- Brush Holder
- Voltage Regulator
- Repair Circuit
- Rectifier
- Diode Trio
- Diode
- Tester



VR-H2009-86S
 *Repairs:
 *VR-H2009-86
 *Voltage Set Point:14.2V



VR-MD07S
 *Repairs:
 *VR-MD07
 *Voltage Set Point:14.4V

Brush Holder

Voltage Regulator









Repair Circuit

Rectifier

Diode Trio

Diode

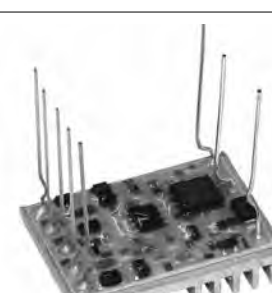
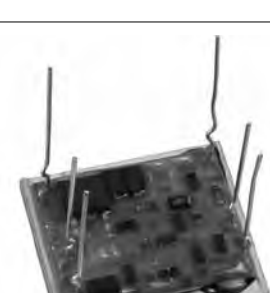
Tester

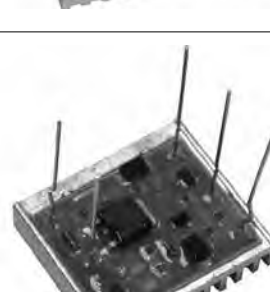
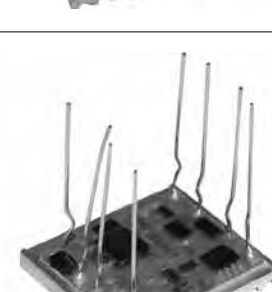
 <p>VR-H2009-105S *Repairs: VR-H2009-105</p>	 <p>VR-H2009-108S *Repairs: VR-H2009-108 with A/M Housing</p>
 <p>VR-H2009-10AS *Repairs: *VR-H2009-10N *VR-H2009-24 *VR-H2009-25 *VR-H2009-26 *VR-H2009-33 *VR-H2009-35 *Voltage Set Point:14.6V</p>	 <p>VR-H2009-112S *VR-H2000-18 *Voltage Set Point:14.5V</p>
 <p>VR-H2009-115S *Repairs: VR-H2009-108 with OE Housing</p>	 <p>VR-H2009-11S *Repairs: *VR-H2009-11H *VR-H2009-41 *Voltage Set Point:14.6V</p>
 <p>VR-H2009-14NS *Repairs: *VR-H2009-14N *Voltage Set Point:14.6V</p>	 <p>VR-H2009-159S *Repairs: VR-H2009-159</p>
 <p>VR-H2009-15S *Repairs: *VR-H2009-15 *Voltage Set Point:14.5V</p>	 <p>VR-H2009-20S *Repairs: *VR-H2009-20 *Voltage Set Point:14.6V</p>
 <p>VR-H2009-38S *Repairs: *VR-H2009-38 *Voltage Set Point:14.5V</p>	 <p>VR-H2009-40S *Repairs: *VR-H2009-40 *Voltage Set Point:14.6V</p>

Brush Holder
Voltage Regulator
Repair Circuit
Rectifier
Diode Trio
Diode
Tester

Brush Holder

Voltage Regulator

Repair Circuit

Rectifier

Diode Trio

Diode

Tester



VR-H2009-43S

*Repairs:
 *VR-H2009-22
 *VR-H2009-37
 *VR-H2009-43
 *Voltage Set Point:14.5V



VR-H2009-44S

*Repairs:
 *VR-H2009-44
 *Voltage Set Point:14.7V



VR-H2009-45S

*Repairs:
 *VR-H2009-45
 *Voltage Set Point:14.5V

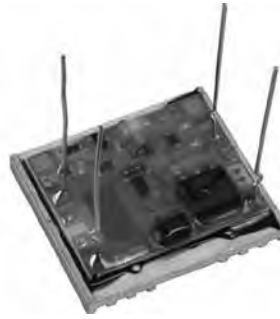

VR-H2009-49S

*Repairs:
 *VR-H2009-49
 *Voltage Set Point:14.6V



VR-H2009-4S

*Repairs:
 *VR-H2009-4H
 *VR-H2009-9H
 *VR-H2009-13H
 *Voltage Set Point:14.7V



VR-H2009-50S

*VR-H2009-50
 *Voltage Set Point:14.5V



VR-H2009-58S

*Repairs:
 *VR-H2009-58
 *Voltage Set Point:14.6V



VR-H2009-5S

*Repairs:
 *VR-H2009-5H
 *VR-H2009-31
 *VR-H2009-6H
 *VR-H2009-28
 *Voltage Set Point:14.6V



VR-H2009-70AS

*Repairs:
 *VR-H2009-70A
 *Voltage Set Point:14.4V



VR-H2009-73S

*Repairs:
 *VR-H2009-73
 *Voltage Set Point:14.4V







VR-H2009-7S

*Repairs:
 *VR-H2009-7H
 *VR-H2009-27
 *VR-H2009-8H
 *VR-H2009-23
 *Voltage Set Point:14.6V



VR-H2009-82S

*Repairs:
 *VR-H2009-82
 *Voltage Set Point:14.7V

 <p>VR-H2009-88S *Repairs: *VR-H2009-88 *Voltage Set Point:14.5V *VR-H2009-88LS *Voltage Set Point:14.4V</p>	 <p>VR-H2009-89S *Repairs: *VR-H2009-89 *Voltage Set Point:14.3V</p>
 <p>VR-H2009-94S *Repair: *VR-H2009-94 *Voltage Set Point:14.5V</p>	 <p>VR-H2009-95S *Repairs: *VR-H2009-95</p>
 <p>VR-H2009-99S *Repairs: *VR-H2009-99 *Voltage Set Point:14.5V</p>	

- Brush Holder
- Voltage Regulator
- Repair Circuit
- Rectifier
- Diode Trio
- Diode
- Tester

**RB-01HA**

*114mm OD
*6-35 Amp Diodes

Replaces

ALFA ROMEO : 701655
AUDI/VW : 028903359A,036903359B,046903359B...
BMW : 12311354682
BOSCH : 1127011112,1127011113,1127011114,1127011115...
FIAT : 60749249,60755038,60777846,9936080,9950095
FORD : 1477517,6017534,6033077,6041730,6154904...
IHC : 3078594R91
LUCAS : UBB411
MERCEDES-BENZ : 1541316,1541416,1542016,1542916...
OPEL : 1205561
SAAB : 8518854,9955293
SEAT : 3980591,NG32033229
STEYR : 61000090743,61200090706
VALMET : 8353310743

Unit No.

BOSCH : 0-120-400-669,0-120-400-670...

**RB-02H**

*114mm OD
*6-35 Amp Diodes

Replaces

ALFA ROMEO : 116.1005.060.04,116.1005.060.08...
AUDI/VW : 046903359A,056903359B,056903371B,46903359...
BMW : 12311266720,12311268409,12311268415...
BOSCH : 1-127-011-117,1-127-011-118,1-127-011-119...
CITROEN : 9405144528
DAF : 692060,694461
DELCO : 90140931,90272286
DELCO REMY (LUCAS) : 21221403
FIAT : 60725868,60736000,60754984,79022471,79031725...
IHC : 3079133R91,3079133R92
IVECO : 79078926
KLOCKNER-HUMBOL-DEUTZ : 42487948,8121110
LANCIA : 82302915,82302916
MAGIRUS-DEUTZ : 8128110,8198792
OPEL : 1205449,1205550,1205551,1205553,1205555...
PEUGEOT : 5744.52,5744.63,5744.67,5744.86,5744.88
SAAB : 8550113,8559825,8571903,8591083
SAME : 294391601
SEAT : 3980278,NG981025.29
TALBOT : 43278800
VOLVO : 1235288,1235577,1259577,1363914,243949...

Unit No.

BOSCH : 0-120-400-471,0-120-400-472...

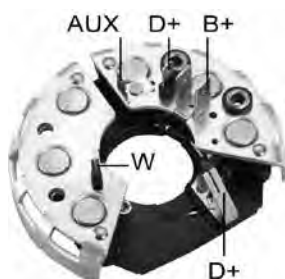
**RB-03HA**

*114mm OD
*6-35 Amp Diodes

Replaces

AUDI/VW : 68903359
BOSCH : 1-127-011-116,1-127-320-506,1-127-320-614...

Unit No.

BOSCH : 0-120-489-080,0-120-489-081...

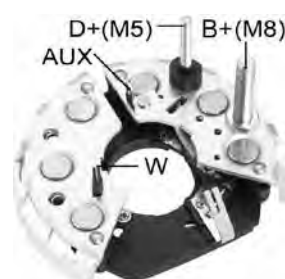
**RB-04H**

*114mm OD
*6-35 Amp Diodes

Replaces

AUDI/VW : 068903539B,068903539C,069903359D
BOSCH : 1127320664,1127320665,1127320666,1127320661...
DELCO REMY (LUCAS) : 21221418
KLOCKNER-HUMBOL-DEUTZ : 1318566
LUCAS : 21221418,UBB420
MAN : 81261090014
VOLVO : 9130086

Unit No.

BOSCH : 0-120-488-134,0-120-488-138...

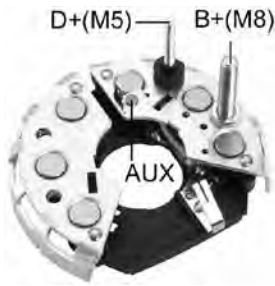
**RB-05H**

*114mm OD
*6-35 Amp Diodes

Replaces

AUDI/VW : 036903359E,036903359F,036903359G,036903359H
BOSCH : 1-127-320-601,1-127-320-661,1-127-320-662...
SAAB : 8598096,9555301
VOLVO : 9130092

Unit No.

BOSCH : 0-120-469-592,0-120-469-959...

**RB-06HA**

*114mm OD
*6-35 Amp Diodes

Replaces

BOSCH : 1-127-011-139,1-127-320-372,1-127-320-580...
DELCO REMY (LUCAS) : 21221419
FORD : 6088149,81AB-10304DA,81DB-10304CA

Unit No.

BOSCH : 0-120-488-176,0-120-488-177...

**RB-07H**

*114mm OD
*6-35 Amp Diodes

Replaces

BOMAG : 5726891
BOSCH : 1-127-011-095,1-127-011-096,1-127-011-097...
CLAAS : 1326530
IHC : 3079385R91,3079411R91
JOHN DEERE : AL30419,AZ31708
KLOCKNER-HUMBOL-DEUTZ : 1304898,1308450,1308783...
MAN : 81261090001,81261090004,81261090005
MERCEDES-BENZ : 1542016,1542116,1542316,1543016...
POCLAIN : B2140611,C2140612
SONACOME : 1120314,1124036
VOLVO : 244343,244488

Unit No.

BOSCH : 0-120-469-603,0-120-469-610...

**RB-08H**

*114mm OD
*6-35 Amp Diodes

Replaces

BOSCH : 1-127-011-098,1-127-011-101,1-127-320-344...
DAF : 694065
FAUN : 4791517
FORD : 6094903,82DB-10304BA
KLOCKNER-HUMBOL-DEUTZ : 1308400,42487053
MAGIRUS-DEUTZ : 8197578,8198257
MERCEDES-BENZ : 1542416,1542516,1542716,1545816...
MWM : 8011080002,8398150001
SAAB : 282916
SCANIA : 282916,305158
STEYR : 61200090706
VOLVO : 6239264,94095

Unit No.

BOSCH : 0-120-488-137,0-120-488-224...

**RB-101H**

*112mm OD
*6-50A Avalanche Diodes

Replaces

BOSCH : 1-127-319-009,1-127-319-623,1-127-319-862

Unit No.

BOSCH : 0-123-320-012,0-986-040-380

**RB-105H**

*112mm OD
*6-50A Avalanche Diodes

Replaces

BOSCH : 1-127-319-570

Unit No.

BOSCH : 0-120-310-023,0-120-310-048...

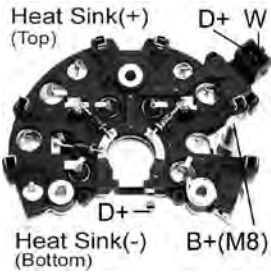
**RB-107H**

*122mm OD
*M8 Battery Post
*6-50A Avalanche Diodes

Replaces

BOSCH : 1127319572,1127319734,1127319540,1127319572...

Unit No.

BOSCH : 0-120-510-053,0-120-510-054...

**RB-108H**

*112mm OD
*6-50A Avalanche Diodes

Replaces

BOSCH : 1-127-319-035,1-127-319-635,1-127-319-710

Unit No.

BOSCH : 0-123-510-004,0-123-510-018...

**RB-10H**

*90mm OD
*6-35 Amp Diodes

Replaces

BOSCH : 1-127-320-152,1-127-320-192,1-127-320-319

FIAT : 4474564,929167,9928604,9934756,9957574...

MAGNETI MARELLI : 74986411,74995001,74995801...

SAME : 294390902

SEAT : 3898152,NG981008.29

STEYR : 30800090739

Unit No.

BOSCH : 0-120-300-568,0-120-300-569...

**RB-110H**

*122mm OD
*6-50A Avalanche Diodes
*M8 Battery Post

Replaces

BOSCH : 1-127-319-558,1-127-319-562,1-127-319-568

Unit No.

BOSCH : 0-123-510-023,0-123-510-031 ...

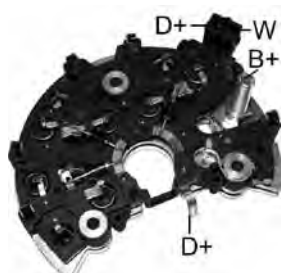
**RB-112H**

*122mm OD
*M8 Battery Post
*12-50A Avalanche Diodes

Replaces

BOSCH : 1-127-319-631

Unit No.

BOSCH : 0-123-520-002,0-123-520-005

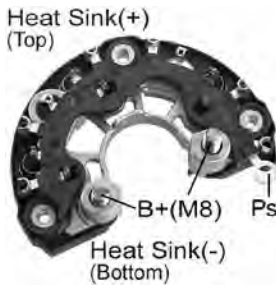
**RB-113H**

*120mm OD
 *M8 Battery Post
 *6-50 Avalanche Diodes

Replaces

BOSCH : F-00M-123-204,F-00M-123-217
Unit No.
BOSCH : 0-124-325-006,0-124-325-007...

**RB-115H**

*120mm OD
 *M8 Battery Post
 *6-50A Avalanche Diodes

Replaces

BOSCH : F00M123202,F00M123337
Unit No.
BOSCH : 0-124-415-001,0-124-415-002...

**RB-116H**

*120mm OD
 *M8 Battery Post
 *6-50A Avalanche Diodes

Replaces

BOSCH : F-00M-123-201
Unit No.
BOSCH : 0-124-225-010,0-124-315-001...

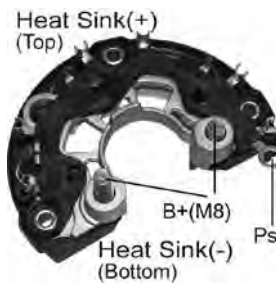
**RB-117H**

*120mm OD
 *M8 Battery Post
 *6-50A Avalanche Diodes

Replaces

BOSCH : F-00M-133-224
Unit No.
BOSCH : 0-124-555-001,0-124-555-002...
MERCEDES-BENZ : 0121541002,0121541102

**RB-118H**

*120mm OD
 *M8 Battery Post
 *8-50A Avalanche Diodes

Replaces

BOSCH : F-00M-113-200
Unit No.
BOSCH : 0-124-225-001,0-124-225-002...

**RB-119H**

*120mm OD
 *M8 Battery Post
 *6-50A Avalanche Diodes

Replaces

BOSCH : F00M133201,F00M133228,F00M133244,F00M133246...
Unit No.
BOSCH : 0-124-512-013,0-124-515-010...

Brush Holder



RB-11H

*90mm OD
*6-35 Amp Diodes

Replaces

ALFA ROMEO : 208000000,700.2080.000.00,700208
BOSCH : 1-127-320-102,1-127-320-114,1-127-320-122...
FIAT : 8223891,82273891,9921409,9923275,9924967...
FORD : 1477518,71BB-10304AA
HANOMAG : 582901738
MERCEDES-BENZ : 1541216

Unit No.

BOSCH : 0-120-300-519,0-120-300-522...

Voltage Regulator



RB-121H

*122mm OD
*M8 Battery Post
*6-50A Avalanche Diodes

Replaces

BOSCH : 1127320807,1127319510,1127319593,1127319729...

Unit No.

BOSCH : 0-120-485-011,0-120-485-012...

Repair Circuit



RB-122H

*112mm OD
*M8 Battery Post
*6-50A Avalanche Diodes

Replaces

BOSCH : 1-127-319-552,1-127-320-852

Unit No.

BOSCH : 0-120-485-034,0-120-485-043...

Rectifier



RB-123H

*3-35 Amp Diodes

Replaces

BOSCH : 1-125-715-064,1-125-715-065,9-121-080-244...

Unit No.

BOSCH : 9-120-080-020,9-120-080-031...

Diode Trio

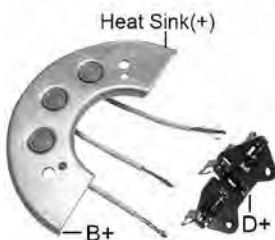

RB-124H

*w/Diode Trios
*3-35 Amp Diodes

Replaces

BOSCH : 1-125-715-064,1-125-715-065,9-121-080-244...

Unit No.

BOSCH : 9-120-080-020,9-120-080-031...

Diode



RB-125H

*3-35 Amp Diodes

Replaces

BOSCH : 9-121-450-310,9-121-450-311,9-121-450-533

Unit No.

BOSCH : 9-190-450-042,9-190-450-044...

Tester

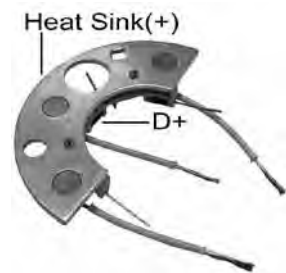

RB-128H
*3-35 Amp Diodes

Replaces
BOSCH : 9-121-450-310,9-121-450-311,9-121-450-533
Unit No.
BOSCH : 9-120-450-042,9-120-450-044...

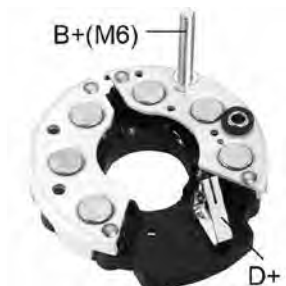

RB-12H
*90mm OD
*6-35 Amp Diodes

Replaces
ALFA ROMEO : 116.0005.061.00,116.0005.061.21
BOSCH : 1-127-320-118,1-127-320-121,1-127-320-342
OPEL : 1205552
Unit No.
BOSCH : 0-120-300-531,0-120-300-537...



RB-130H
*w/Diode Trios
*M5 Battery Post
*3-35 Amp Diodes

Replaces
BOSCH : 9-121-080-374
Unit No.
BOSCH : 9-120-080-045,9-120-080-049...

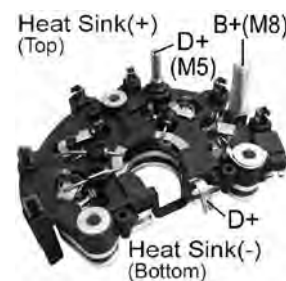

RB-134H
*M5 Battery Post
*6-50A Avalanche Diode

Replaces
BOSCH : 1-127-319-011,1-127-319-560,1-127-319-749
Unit No.
BOSCH : 0-123-310-042,0-123-315-020...

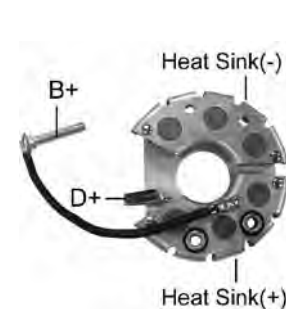

RB-137H
*M6 Battery Post
*6-35A Amp Diodes
Replaces
BOSCH : 9-121-080-595
Unit No.
BOSCH : 9-120-080-041,
9-120-080-061...

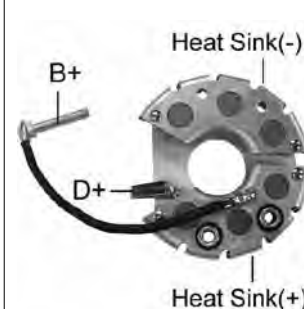

RB-137HV
Same as RB-137H but W/6-50 Amp Diodes
*M6 Battery Post
Replaces
BOSCH : 9-121-080-595
Unit No.
BOSCH : 9-120-080-041,
9-120-080-061 ...



RB-138H
*M5 Battery Post
*6-35 Amp Diodes

Replaces
BOSCH : 9-122-080-638
Unit No.
BOSCH : 9-120-080-197

Brush Holder

Voltage Regulator

Repair Circuit

Rectifier

Diode Trio

Diode

Tester

Brush Holder

Voltage Regulator

Repair Circuit

Rectifier

Diode Trio

Diode

Tester



RB-13H

*90mm OD
*M6 Battery Post
*6-35 Amp Diodes

Replaces

BOMAG : 5726892
BOSCH : 1-127-320-115,1-127-320-116,1-127-320-141...
IHC : 3078957R91,3078957R92
JOHN DEERE : AL27374,AZ24486
KLOCKNER-HUMBOL-DEUTZ : 1306533,9941262
LAMBORGHINI : 294390706,294391002
MWM : 8011080001,8339940004,833994001,8398150001...
Unit No.
BOSCH : 0-120-300-535,0-120-300-552...



RB-141H

*M8 Battery Post
*8-50 Amp Diodes

Replaces

BOSCH : 9-128-041-566

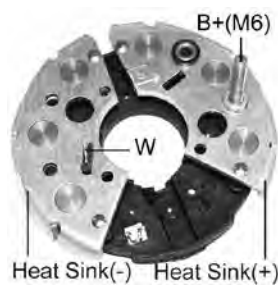

RB-145H

*M6 Battery Post
*6-35 Amp Diodes

Replaces

BOSCH : 9-122-080-923
Unit No.
BOSCH : 9-120-080-215, 9-120-080-222...

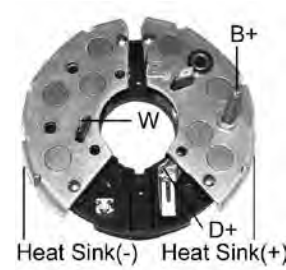

RB-146H

*M6 Battery Post
*8-35A Avalanche Diode

Replaces

BOSCH : F-000-LD1-006
Unit No.
BOSCH : 9-120-080-226,9-120-080-232...

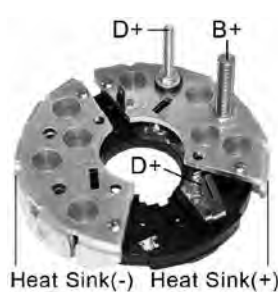

RB-148H

*M8 Battery Post
*8-35 Amp Diodes

Replaces

BOSCH : 9-122-080-676
Unit No.
BOSCH : 9-120-080-167



RB-14H

*114mm OD
*M8 Battery Post
*6-35 Amp Diodes

Replaces

BOSCH : 1-127-320-909,9-127-041-132,9-127-041-133...
MERCEDES-BENZ : 1547016
Unit No.
BOSCH : 0-120-489-316

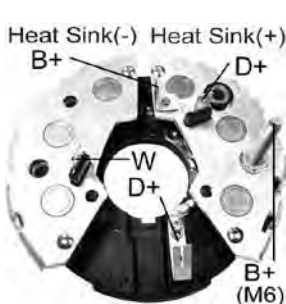

RB-158H

*115mm OD
*M6 Battery Post
*6-35 Amp Diodes

Replaces

BOSCH : F-000-LD1-012
Unit No.
BOSCH : 9-120-080-212,9-120-080-230

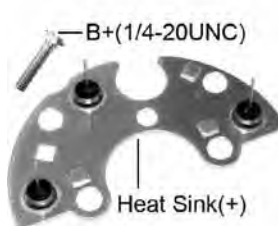

RB-159H

*115mm OD
*3-35 Amp Diodes

Unit No.

BOSCH : 9-120-450-006, 9-120-450-124
FORD : 87HLL-10300DA, E5HT-10300EA



RB-15H
 *114mm OD
 *M6 Battery Post
 *6-35 Amp Diodes

Replaces
 BOSCH : 1-127-320-668
Unit No.
 BOSCH : 0-120-488-125,
 0-120-489-156...



RB-160H
 *112mm OD
 *M6 Battery Post
 *6-50A Avalanche Diodes

Replaces
 BOSCH : 1-127-319-584
Unit No.
 BOSCH : 0-120-485-029,
 0-123-310-014...

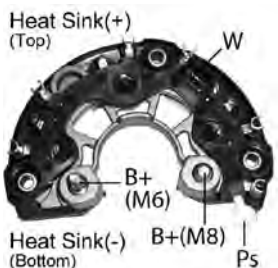

RB-161H
 *120mm OD
 *M6 Battery Post
 *6-50 Avalanche Diodes

Unit No.
 BOSCH : 0-124-325-064
 FORD : 1C35-10300AA,1C35-10300AB

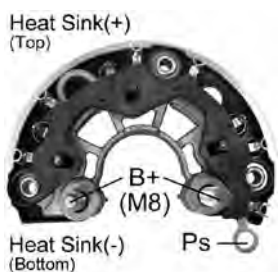

RB-163H
 *130mm OD
 *M8 Battery Post
 *6-50A Avalanche Diodes

Replaces
 BOSCH : F-00M-133-206,F-00M-133-230,F-00M-133-248
Unit No.
 BOSCH : 0-124-515-028,0-124-515-040...
 MERCEDES : A2711540802



RB-166H
 *130mm OD
 *M8 Battery Post
 *6-70A Avalanche Diodes

Replaces
 BOSCH : F00M133276,F00M133249,F00M133204,F00M133214...
Unit No.
 BOSCH : 0-124-625-001,0-124-625-003...



RB-167HV
 *130mm OD
 *M8 Battery Post
 *6-50A Avalanche Diodes
 * △ connection

Replaces
 BOSCH : F-00M-123-265
Unit No.
 BOSCH : 0-124-325-121,0-124-325-153
 GM : 15200267,15222342



RB-168H
 *130mm OD
 *M8 Battery Post
 *6-50A Avalanche Diodes

Replaces
 BOSCH : F00M133226,F00M133369,F00M133372
Unit No.
 BMW : 12317501595,12317501597,12317501599...
 BOSCH : 0-124-515-050,0-124-515-097

Brush Holder

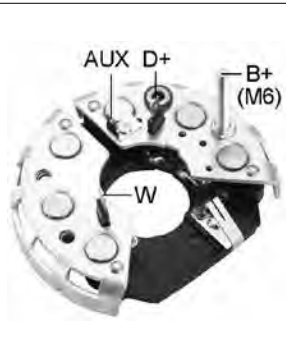

RB-16H
 *114mm OD
 *M6 Battery Post
 *6-35 Amp Diodes

Replaces
BOSCH : 1-127-011-131

Unit No.
BOSCH : 0-120-489-069,0-120-489-070...

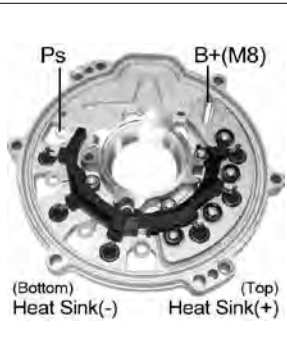

RB-170HD
 *M8 Battery Post
 *6-70A Avalanche Diodes

Replaces
BOSCH : F-00M-256-202

Unit No.
BOSCH : 0-122-468-015

Voltage Regulator



RB-171HV
 *120mm OD
 *6-50 Amp Diodes

Replaces
BOSCH : F-00M-133-202

Unit No.
BOSCH : 0-124-525-002, 0-124-525-003...
CHRYSLER : 56041120AC, 56041322,56041322AB

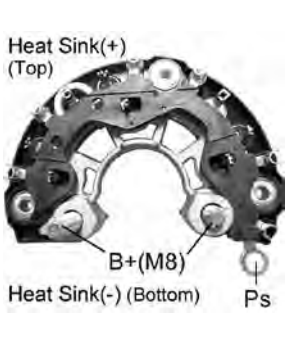

RB-172H
 *120mm OD
 *M8 Battery Post
 *6-50A Avalanche Diodes

Replaces
BOSCH : F-00M-123-249, F-00M-123-228,F-00M-123-238...

Unit No.
BOSCH : 0-124-325-066, 0-124-325-076...

Repair Circuit



RB-174HD
 *130mm OD
 *M8 Battery Post
 *6-70A Avalanche Diodes

Replaces
BOSCH : F-00M-133-267,F-00M-133-311

Unit No.
BMW : 12317532965,12317532966,12317532969...
BOSCH : 0-124-525-059,0-124-525-063

Replaces
BOSCH : F-00M-133-265,F-00M-133-278,F-00M-133-312...

Unit No.
BOSCH : 0-124-525-026

Rectifier

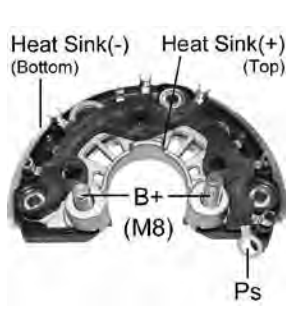

RB-175HD
 *130mm OD
 *M8 Battery Post
 *6-70A Avalanche Diodes

Replaces
BOSCH : F-00M-133-265,F-00M-133-278,F-00M-133-312...

Unit No.
BOSCH : 0-124-525-026

Replaces
BOSCH : 1127319738,1127320854,1127319737,1127319576
VOLKSWAGEN : 028-903-359G

Unit No.
BOSCH : 0-986-038-950,0-986-039-030...

Diode Trio

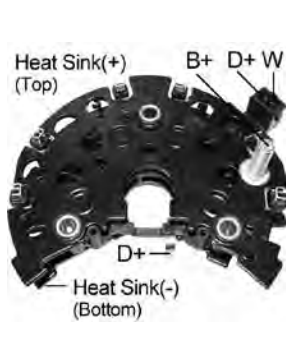

RB-178H
 *122mm OD
 *8-35 Amp Diodes

Replaces
BOSCH : 1127319738,1127320854,1127319737,1127319576
VOLKSWAGEN : 028-903-359G

Unit No.
BOSCH : 0-986-038-950,0-986-039-030...

Replaces
BOSCH : 1127319738,1127320854,1127319737,1127319576
VOLKSWAGEN : 028-903-359G

Unit No.
BOSCH : 0-986-038-950,0-986-039-030...

Diode

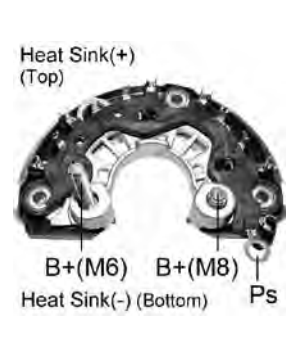

RB-179HV
 *130mm OD
 *M8 Battery Post
 *6-50A Avalanche Diodes
 *Y connection

Replaces
BOSCH : F-00M-123-266

Unit No.
BOSCH : 0-124-325-133
GM : 15124532



RB-17H
 *114mm OD
 *M8 Battery Post
 *6-35 Amp Diodes

Replaces
BOSCH : 9-121-147-302
OPEL : 1205568,90010012

Unit No.
BOSCH : 0-120-488-000, 0-120-488-001...

Tester

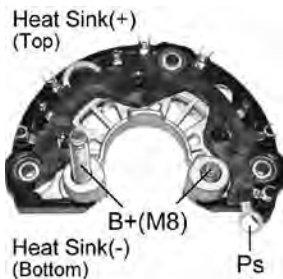

RB-180HV
 *120mm OD
 *M8 Battery Post
 *6-50 Amp Diodes

Replaces
 BOSCH : F-00M-133-225
Unit No.
 BOSCH : 0-124-425-001,0-124-525-004...
 CHRYSLER : 4801475AA,AB; 56028238AB,56028239AB...

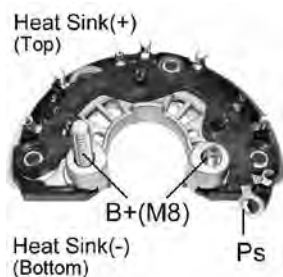

RB-181HD
 *M8 Battery Post
 *6-70A Avalanche Diodes
Replaces
 BOSCH : F-00M-133-274,
 F-00M-133-292
Unit No.
 BOSCH : 0-124-525-054,
 0-124-525-055

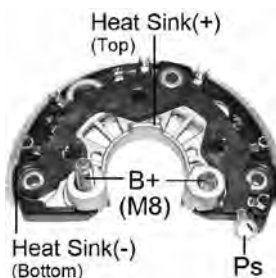

RB-184HV
 *130mm OD
 *M8 Battery Post
 *6-50A Avalanche Diodes
Unit No.
 BOSCH : 0-124-615-029

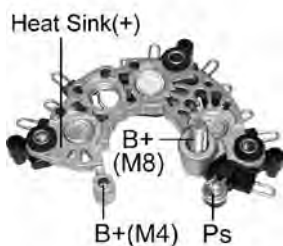

RB-185HV
 *117mm OD
 *M8 Battery Post
 *3-50A Avalanche Diodes
 *Positive Rectifier

Unit No.
 BOSCH : F-000-BL0-424,F-000-BL0-618

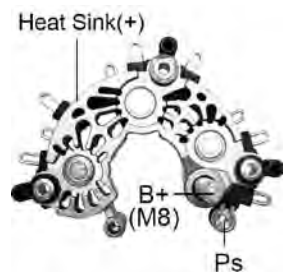

RB-187H
 *117mm OD
 *M8 Battery Post
 *3-50A Avalanche Diodes
 *Positive Rectifier

Replaces
 BOSCH : F-000-BL9-043
Unit No.
 BOSCH : F-000-BL0-830,F-000-BL0-818...
 VOLKSWAGEN : 04E903023B,04E903023J,04E903023JX

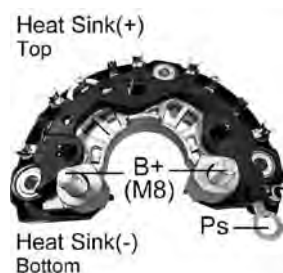

RB-188H
 *120mm OD
 *M8 Battery Post
 *6-50A Avalanche Diodes

Replaces
 BOSCH : F-00M-123-251,F-00M-123-268,F-00M-123-280
Unit No.
 BOSCH : 0-124-325-116,0-124-325-087...

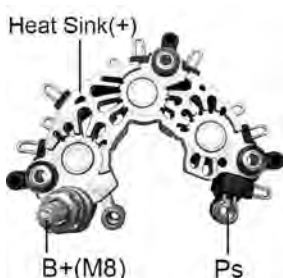

RB-189H
 *117mm OD
 *M8 Battery Post
 *3-50A Avalanche Diodes
 *Positive Rectifier

Unit No.
 BOSCH : F-000-BL0-740,F-000-BL0-743

Brush Holder

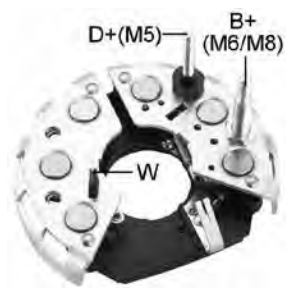

RB-18H
 *114mm OD
 *M6/M8 Battery Post
 *6-35 Amp Diodes

Replaces
BOSCH : 1127320914
GM : 90350009
OPEL : 1205572
Unit No.
BOSCH : 0-120-488-186,0-120-488-187

Voltage Regulator

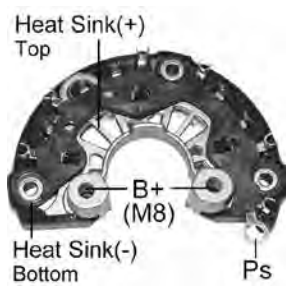

RB-190H
 *124mm OD
 *M8 Battery Post
 *8-50A Avalanche Diodes

Replaces
BOSCH : F-00M-113-219
Unit No.
BOSCH : 0-124-225-051,0-124-225-055
TOYOTA : 27060-0Q040,27060-ON011

Repair Circuit

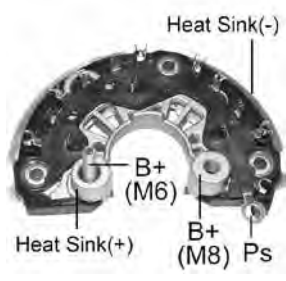

RB-194H
 *130mm OD
 *M6 Battery Post
 *6-50A Avalanche Diodes

Replaces
BOSCH : F-00M-123-270
Unit No.
BOSCH : 0-124-325-134

Rectifier

RB-195H
Replaces
BOSCH : F-00M-599-451
Unit No.
BOSCH : 0-125-711-134,
 0-125-711-030

PICTURE IS NOT AVAILABLE

RB-196H
Replaces
BOSCH : F-00M-599-451
Unit No.
FORD : GX73-10300-DE

PICTURE IS NOT AVAILABLE

Diode Trio

RB-197H

PICTURE IS NOT AVAILABLE

Replaces
BOSCH : F-00M-599-545,F-00M-599-507
Unit No.
BMW : 123 8 614 277
BOSCH : 0-125-813-016,0-125-813-015

Diode

Tester

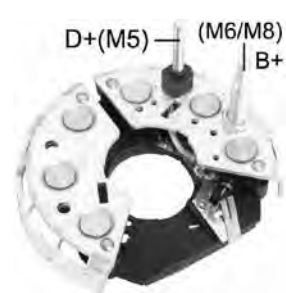

RB-19H
 *114mm OD
 *M6/M8 Battery Post
 *6-35 Amp Diodes

Replaces
BOSCH : 1-127-320-651,1-127-320-677
GM : 90349909
OPEL : 1205571,1205573,90017587
Unit No.
BOSCH : 0-120-488-156,0-120-488-157...

 <p>RB-24H *112mm OD *M8 Battery Post *8-50A Avalanche Diodes Replaces BOSCH : 1-127-319-667, 1-127-320-850 Unit No. BOSCH : 0-120-485-036, 0-120-485-038...</p>	 <p>RB-26H *122mm OD *M6 Battery Post *6-50A Avalanche Diodes Replaces BOSCH : 1-127-319-033, 1-127-319-580, 1-127-319-715 Unit No. BOSCH : 0-123-212-001</p>
 <p>RB-28H *122mm OD *M8 Battery Post *8-50A Avalanche Diodes Replaces BOSCH : 1-127-319-512, 1-127-320-818 Unit No. BOSCH : 0-120-465-018, 0-120-465-029</p>	 <p>RB-29H *122mm OD *M8 Battery Post *14-50A Avalanche Diodes Replaces BOSCH : 1-127-319-031, 1-127-319-637 Unit No. BOSCH : 0-120-465-003, 0-120-465-004...</p>
 <p>RB-30H *112mm OD *M8 Battery Post *8-50A Avalanche Diodes Replaces BOSCH : 1-127-319-019 Unit No. BOSCH : 0-123-320-003,0-123-340-001...</p>	
 <p>RB-32H *106mm OD *M8 Battery Post *8-50A Avalanche Diodes Replaces BOSCH : 1-127-319-005, 1-127-319-601,1-127-319-766 Unit No. BOSCH : 0-123-110-005, 0-123-120-001</p>	 <p>RB-33H *122mm OD *M8 Battery Post *6-50A Avalanche Diodes Replaces BOSCH : 1127319013, 1127319597,1127319778, 1127319743... Unit No. BOSCH : 0-123-505-001, 0-123-510-003...</p>
 <p>RB-36H *112mm OD *M8 Battery Post *6-50A Avalanche Diodes Replaces BOSCH : 1-127-319-522, 1-127-319-607,1-127-319-694 Unit No. BOSCH : 0-123-310-010,0-123-310-011...</p>	 <p>RB-37H *112mm OD *M8 Battery Post *6-50A Avalanche Diodes Replaces BOSCH : 1-127-319-530, 1-127-319-599,1-127-319-726 Unit No. BOSCH : 0-123-100-001, 0-123-100-002</p>
 <p>RB-38H *114mm OD *M6 Battery Post *6-35 Amp Diodes Replaces BOSCH : 1127320667,1127319113 FORD : 6156187,86AB10304AA GM : 90350013 LUCAS : 2131030,UBB429 MAGNETI MARELLI : 940038210 Unit No. BOSCH : 0-120-488-228,0-120-488-286...</p>	

Brush Holder

Voltage Regulator

Repair Circuit

Rectifier

Diode Trio

Diode

Tester



RB-40H
 *120mm OD
 *M8 Battery Post
 *14-35 Amp Diodes

Replaces
 BOSCH : 1-127-320-584,
 1-127-320-608

Unit No.
 BOSCH : 0-120-469-623,
 0-127-469-624



RB-41H
 *120mm OD
 *12-35 Amp Diodes

Replaces
 BOSCH : 1-127-011-157,
 1-127-320-565

Unit No.
 BOSCH : 0-120-469-586,
 0-120-469-588...



RB-42H
 *120mm OD
 *12-35 Amp Diodes

Replaces
 BOSCH : 1-127-320-369
 FORD : 78GB-10304AA
 MERCEDES-BENZ : 1543516

Unit No.
 BOSCH : 0-120-469-516,
 0-120-469-517...

Replaces
 AUDI/VW : 053903359C
 BOSCH : 1-127-320-360,
 1-127-320-538
 LUCAS : 21221435
 MERCEDES-BENZ : 1544116

Unit No.
 BOSCH : 0-120-469-515,0-120-469-534...



RB-43H
 *120mm OD
 *12-35 Amp Diodes

Replaces
 AUDI/VW : 069903359A
 BOSCH : 1-127-320-515

Unit No.
 BOSCH : 0-120-469-541,
 0-120-469-542...

Replaces
 BOSCH : 1-127-320-370

Unit No.
 BOSCH : 0-120-450-008,
 0-120-450-009...



RB-46H
 *120mm OD
 *12-35 Amp Diodes

Replaces
 AUDI/VW : 069903359A
 BOSCH : 1-127-320-515

Unit No.
 BOSCH : 0-120-469-541,
 0-120-469-542...



RB-47H
 *120mm OD
 *14-35 Amp Diodes

Replaces
 BOSCH : 1-127-320-370

Unit No.
 BOSCH : 0-120-450-008,
 0-120-450-009...



RB-48H
 *120mm OD
 *6-35 Amp Diodes

Replaces
 BOSCH : 1-127-320-721

Unit No.
 BOSCH : 0-120-469-828,
 0-120-469-829...



RB-49H
 *120mm OD
 *6-35 Amp Diodes

Replaces
 BOSCH : 1127320717,
 1127320726,1127320734,
 1127320740...

Unit No.
 BOSCH : 0-120-468-042,
 0-120-468-043...



RB-50H
 *120mm OD
 *8-35 Amp Diodes

Replaces
 BOSCH : BOSCH : 1-127-320-727

Unit No.
 BOSCH : 0-120-469-878,0-120-469-879...

Replaces
 BOSCH : BOSCH : 1-127-320-727

Unit No.
 BOSCH : 0-120-469-878,0-120-469-879...

**RB-51H**

*120mm OD
*8-35 Amp Diodes

Replaces

BOSCH : 1-127-320-700,1-127-320-730
FIAT : 9941712,9942883,9950118,9950193
FORD : 1632835,E5RD10304AA

Unit No.

BOSCH : 0-120-469-028,0-120-469-029...

**RB-52H**

*120mm OD
*6-35 Amp Diodes

Replaces

BOSCH : 1-127-320-704
FIAT : 9939575,9950067

Unit No.

BOSCH : 0-120-469-646,
0-120-469-647...

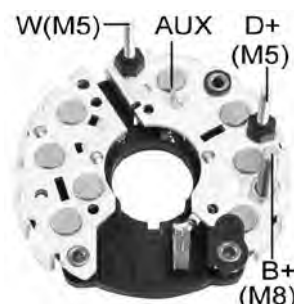
**RB-53H**

*120mm OD
*8-35 Amp Diodes

Replaces

BOSCH : 1-127-320-706
FORD : 6153350,85GB-10304CA,
86GB-10304CA

Unit No.

BOSCH : 0-120-469-009,
0-120-469-032...

**RB-54H**

*120mm OD
*8-35 Amp Diodes

Replaces

AUDI/VW : 037903359A,26903359,27903359
BMW : 12311715167
BOSCH : 1-127-320-705,1-127-320-715,1-127-320-723...
LUCAS : UBB433
MAGNETI MARELLI : 940038208
MERCEDES-BENZ : 1545916
OPEL : 1205453,90349703,90443928

Unit No.

BOSCH : 0-120-427-988,0-120-468-017...

**RB-55H**

*120mm OD
*6-35 Amp Diodes

Replaces

BMW : 12311288457
BOSCH : 1-127-320-702,1-127-320-709,1-127-320-722
OPEL : 1205455,90349855
VOLVO/DAF : 9130095

Unit No.

BOSCH : 0-120-469-618,0-120-469-619...

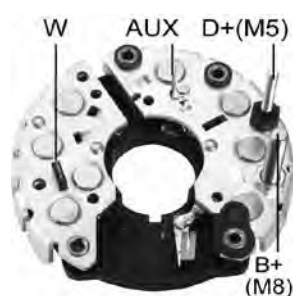
**RB-56H**

*120mm OD
*8-35 Amp Diodes

Replaces

AUDI/VW : 75903359
BOSCH : 1-127-320-708,1-127-320-731
LUCAS : UBB432
MAGNETI MARELLI : 940038206
MERCEDES-BENZ : 1547916

Unit No.

BOSCH : 0-120-469-015,0-120-469-020...

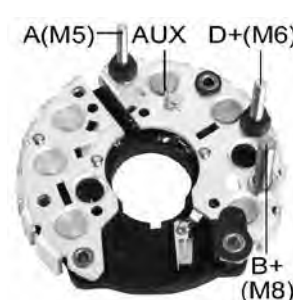
**RB-57H**

*120mm OD
*6-35 Amp Diodes

Replaces

BOSCH : 1-127-320-707
FORD : 6153349,85GB-1034BA

Unit No.

BOSCH : 0-120-469-655,
0-120-469-656...

**RB-58H**

*120mm OD
*8-35 Amp Diodes

Replaces

BOSCH : 1-127-320-712,
1-127-320-735

Unit No.

BOSCH : 0-120-469-784,
0-120-469-785...

Brush Holder

Voltage Regulator

Repair Circuit

Rectifier

Diode Trio

Diode

Tester



RB-59H
 *120mm OD
 *6-35 Amp Diodes

Replaces
BOSCH : 1-127-320-713
 VOLVO/DAF : 1398640

Unit No.
BOSCH : 0-120-468-009,
 0-120-468-010...



RB-60H
 *120mm OD
 *6-35 Amp Diodes

Replaces
BOSCH : 1-127-320-711
 VOLVO/DAF : 1363741

Unit No.
BOSCH : 0-120-469-750,
 0-120-469-751...

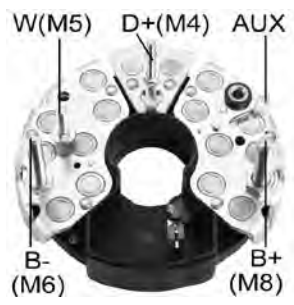

RB-62H
 *120mm OD
 *14-35 Amp Didoes

Replaces
BOSCH : 1-127-320-390,
 1-127-320-959

Unit No.
BOSCH : 0-120-469-014,
 0-120-469-522



RB-63H
 *120mm OD
 *8-35 Amp Diodes

Replaces
BOSCH : 1-127-320-590,
 1-127-320-977

Unit No.
BOSCH : 0-120-469-549,
 0-120-469-569...

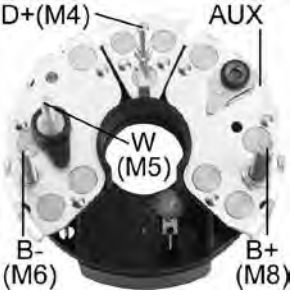

RB-66H
 *120mm OD
 *8-50A Avalanche Diodes

Replaces
BOSCH : 1-127-320-602,1-127-320-924,1-127-320-951...
MAN : 81261090016
VOLVO : 1698182

Unit No.
BOSCH : 0-120-468-037,0-120-488-208...

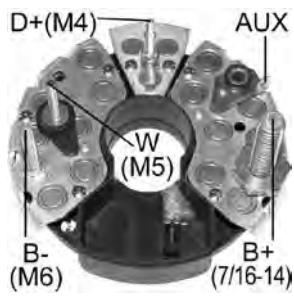

RB-67H
 *120mm OD
 *14-50A Avalanche Diode

Replaces
BOSCH : 1-127-320-954

Unit No.
BOSCH : 0-120-468-028,
 0-120-468-055

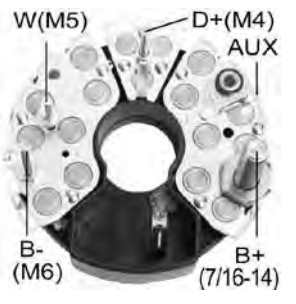

RB-67HA
 * 120mm OD
 * 14-50 Amp Diode

Replaces
BOSCH : 1-127-320-920

Unit No.
BOSCH : 0-120-468-028,
 0-120-468-055

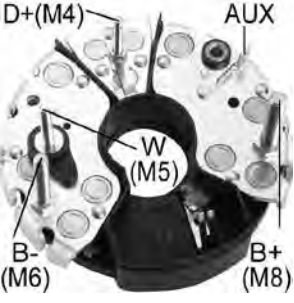

RB-71H
 *120mm OD
 *8-50A Avalanche Diodes

Replaces
BOSCH : 1-127-320-928,1-127-320-946,1-127-320-956...
IVECO : 93160252
KHD : 1318310
MAN : 81261090018
VOLVO : 3090260,3090262,68132

Unit No.
BOSCH : 0-120-465-010,0-120-468-107...

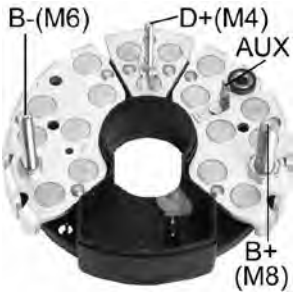

RB-72H
 *120mm OD
 *14-35 Amp Diodes

Replaces
AUDI/VW : 049903359D
BOSCH : 1-127-320-361,1-127-320-379,1-127-320-386...
FORD : 613319,83DB-10304AA
LUCAS : UBB434
VOLVO : 244610,698121

Unit No.
BOSCH : 0-120-450-010,0-120-450-015...



RB-73H
 *122mm OD
 *M5 W Post
 *8-35 Amp Diodes

Replaces
BOSCH : 1127320961,1127320388,1127320390,1127320395...
RENAULT : 1127320960
Unit No.
BOSCH : 0-120-450-015,0-120-468-518...

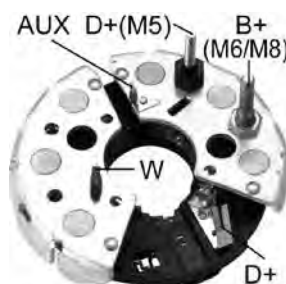

RB-74H
 *114mm OD
 *6-50A Avalanche Diode
Replaces
BOSCH : 1-127-319-104
Unit No.
BOSCH : 0-120-488-283



RB-75H
 *120mm OD
 *M6 Battery Post
 *6-35 Amp Diodes
Replaces
BOSCH : 1-127-320-718, 1-127-320-719
Unit No.
BOSCH : 0-120-450-012, 0-120-450-014...



RB-77H
 *120mm OD
 *8-35 Amp Diodes

Replaces
BOSCH : 1-127-320-720, 1-127-320-741,1-127-320-911
Unit No.
BOSCH : 0-120-468-007, 0-120-468-008...

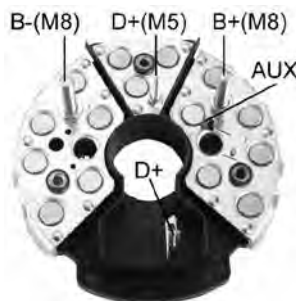

RB-78H
 *145mm OD
 *M8 Battery Post
 *12-50A Avalanche Diodes

Replaces
BOSCH : 1-127-320-973
IVECO : 93163820
KHD : 1319100
MERCEDES-BENZ : 0011540816
SCANIA : 1347012
VOLVO : 3097306
Unit No.
BOSCH : 0-120-689-533,0-120-689-534...



RB-78HA
 *145mm OD
 *14-35 Amp Diodes
 *With W terminal

Replaces
BOSCH : 1-127-320-547,1-127-320-550,1-127-320-571
IVECO : 8122274
KHD : 1320547
MAGIRUS-DEUTZ : 1309660
MERCEDES-BENZ : 0001545116,0001545416
SAAB : 424968
VOLVO : 1698762,696002
Unit No.
BOSCH : 0-120-489-503,0-120-505-010...

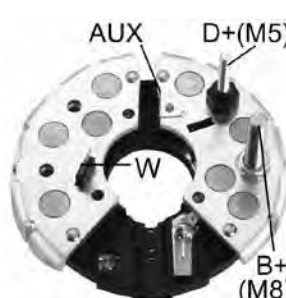

RB-80H
 *114mm OD
 *8-50A Avalanche Diode(19~24V)
Replaces
BOSCH : 1127320692
Unit No.
BOSCH : 0-120-484-001, 0-120-484-011...

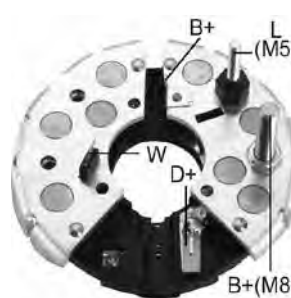

RB-80HA
 *114mm OD
 *8-50A Avalanche Diodes(32~40V)
Replaces
BOSCH : 9-122-067-305

Brush Holder

Voltage Regulator

Repair Circuit

Rectifier

Diode Trio

Diode

Tester

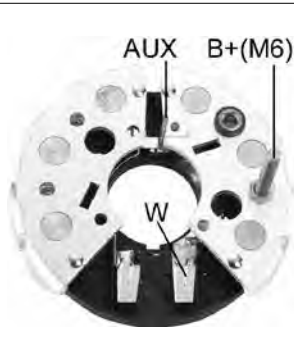

RB-81H
 *114mm OD
 *6-50A Avalanche Diode

Replaces
BOSCH : 9-121-067-379
Unit No.
BOSCH : 9-120-060-027

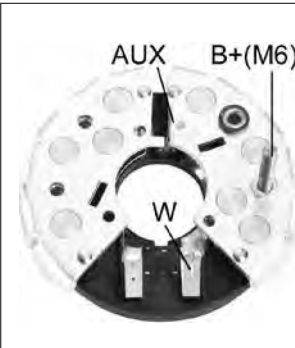

RB-82H
 *114mm OD
 *8-35 Amp Diodes

Replaces
FORD : E9YJ-10304A
Unit No.
BOSCH : 9-120-060-020
FORD : E9YJ-10346A

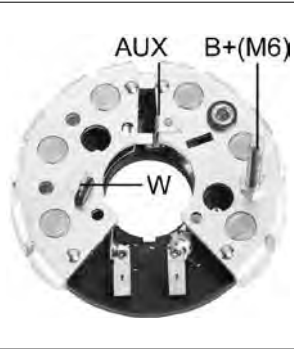

RB-83H
 *114mm OD
 *6-50A Avalanche Diodes

Unit No.
BOSCH : 9-120-067-027

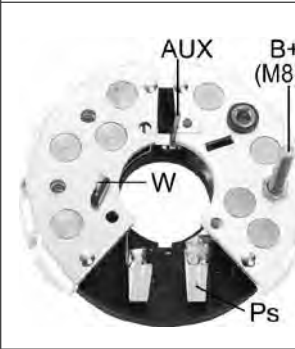

RB-84H
 *114mm OD
 *8-50A Avalanche Diodes

Replaces
BOSCH : 9121067067,91210673
 64,9121067371,9121067374...
Unit No.
BOSCH : 9-120-060-009,
 9-120-060-023...

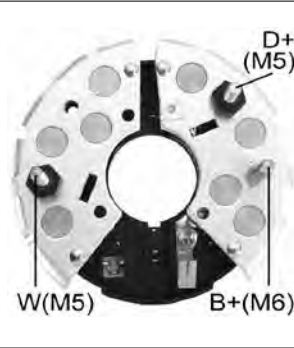

RB-85H
 *114mm OD
 *M6 Battery Post
 *8-35 Amp Diodes

Replaces
BOSCH : 9-128-040-953J
Unit No.
BOSCH : 9-120-180-020J

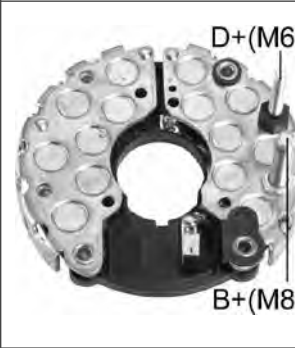

RB-87H
 *120mm OD
 *14-35 Amp Diodes

Replaces
BOSCH : 1-127-320-901,
 1-127-320-912,1-127-320-918...
Unit No.
BOSCH : 0-100-468-074,
 0-120-468-013...

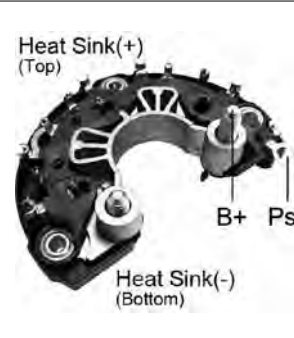

RB-926H
 *118mm OD
 *6-50A Avalanche Diodes
 *Y connection
 *Replace to part number
 RB-126H

Replaces
AUDI/WW : 038903359D
BOSCH : F-00M-123-226,F-00M-123-229
MEC(OLD) : RB-126H
Unit No.
BOSCH : 0-124-325-050,0-124-325-051

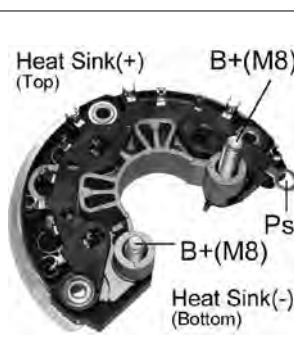

RB-929H
 *M8 Battery Post
 *130mm OD
 *Delta connection
 *6-50A Avalanche Diodes
 *Replace to part number
 RB-129H

Replaces
BOSCH : F00M133215,F00M133218,F00M133247,F00M133259...
MEC(OLD) : RB-129H
Unit No.
BOSCH : 6-004-ML0-017,6-004-ML0-021

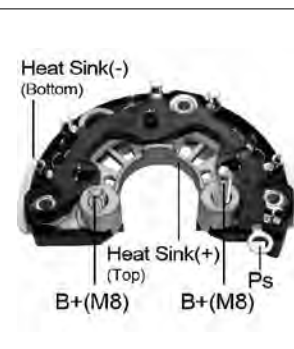

RB-929HV
 *M8 Battery Post
 *130mm OD
 *Delta connection
 *6-70A Avalanche Diodes
 *Replace to part number
 RB-129HV

Replaces
BOSCH : F-00M-133-215,F-00M-133-218,F-00M-133-247...
MEC(OLD) : RB-129HV
Unit No.
BOSCH : 6-004-ML0-017,6-004-ML0-021

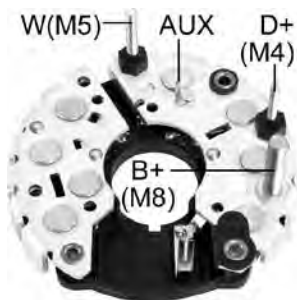

RB-93H
 *120mm OD
 *8-50A Avalanche Diodes

Replaces
BOSCH : 1127320753,1127320750
DAF : 132114
IVECO : 42531816
MERCEDES-BENZ : 0005481416,0011542216
Unit No.
BOSCH : 0 120 468 143,0 120 468 145...
MERCEDES-BENZ : 0101549102,0101549202

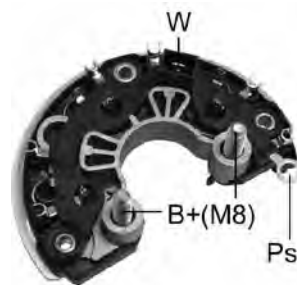

RB-952H
 *130mm OD
 *M8 Battery Post
 *6-50 Avalanche Diodes
 *Replace to part number RB-152H

Replaces
BOSCH : F-00M-133-269
MEC(OLD) : RB-152H

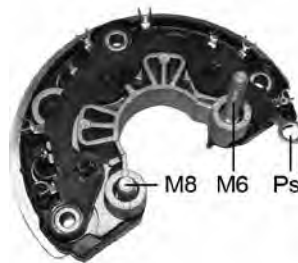

RB-954H
 *130mm OD
 *M6 Battery Post
 *6-70A Avalanche Diodes
 *Replace to part number RB-154H

Replaces
BOSCH : F-00M-133-277
MEC(OLD) : RB-154H
Unit No.
BOSCH : 0-124-525-072

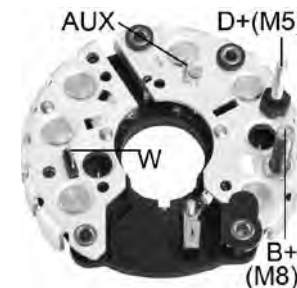

RB-96H
 *120mm OD
 *6-35 Amp Diodes

Replaces
BOSCH : 1-127-320-743
Unit No.
BOSCH : 0-120-468-080,
 0-120-468-081...

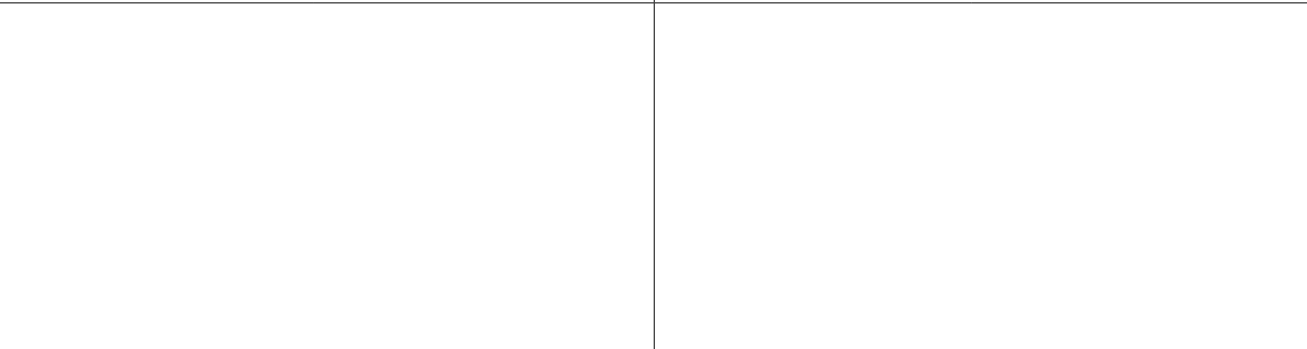
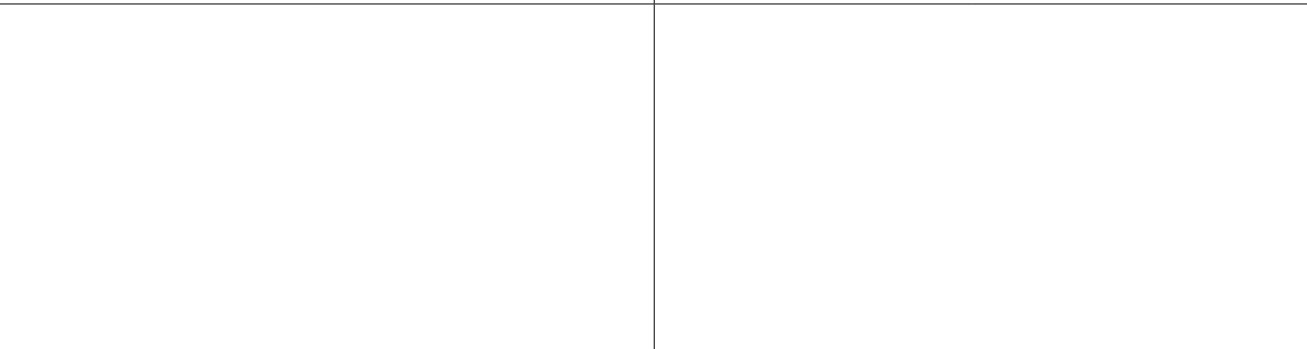
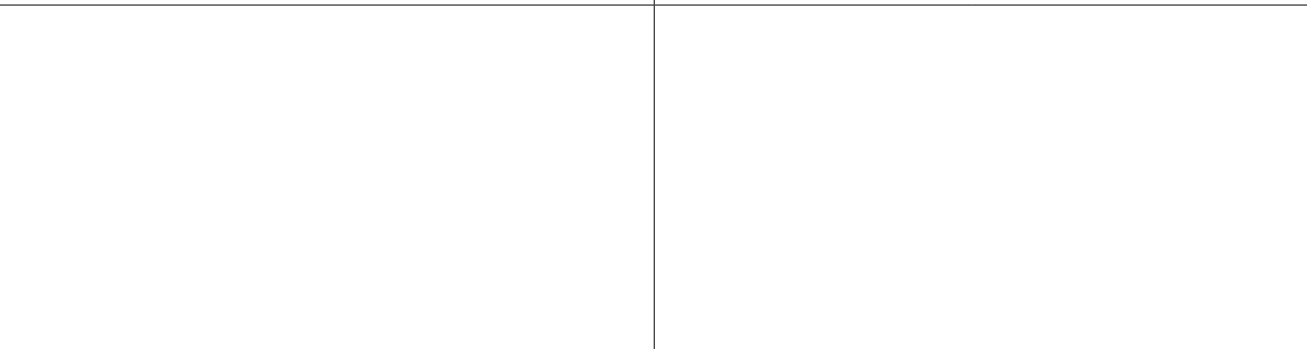

Brush Holder

Voltage Regulator

Repair Circuit

Rectifier

Diode Trio

Diode

Tester

Brush Holder

Voltage Regulator



Repair Circuit

Rectifier

Diode Trio

Diode

Tester

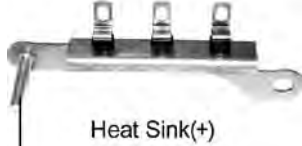
<p>Heat Sink(+) Top</p>  <p>Heat Sink(-) Bottom</p>	<p>RC-19 *3-50 Amp Diodes *Without Terminal</p> <p>Replaces CHRYSLER : 4364855,4467162, 5226009</p>	<p>RC-21N *Negative *3-25 Amp Diodes</p>  <p>Heat Sink (-)</p>	<p>Replaces CHRYSLER : 3438721,3755114</p>
 <p>Heat Sink(+) B+ (1/4-20uNC)</p>	<p>RC-21P *Positive *3-25 Amp Diodes</p> <p>Replaces CHRYSLER : 3438727,3874268, 3874269,3874343,4026082...</p>		

 <p>RD-16 *8-50 Amp Diodes</p> <p>Replaces DAEWOO : 262100,267000, 276000</p> <p>Heat Sink(+) Heat Sink(-)</p>	 <p>RD-32 *6-50A Avalanche Diodes</p> <p>Unit No. DAEWOO : 219170,96380673, 266000 DELCO : 19020601,19020609, 19020611,19020612</p> <p>B+(M6) D+</p>
 <p>RD-04B *O.E. TYPE with 6-50A Avalanche Diodes</p> <p>Replaces DELCO : 10475034,1205464, 589714,10475034</p> <p>Unit No. DELCO : 10479914,10479923, 10479947,10479955...</p> <p>B+(M8) D+</p>	 <p>RD-05 *6-50 Amp Diodes *Wide Fin Gull Wing Style Heat Sinks</p> <p>Replaces DELCO : 1988976,D3987</p> <p>Unit No. DELCO : 1105585,1105680, 1105683,1105690,1117880...</p> <p>(Top) Heat Sink(+) Heat Sink(-) (Bottom)</p>
 <p>RD-06 *6-50A Avalanche Diodes *Wide Fin Gull Wing Style Heat Sink *For use on 21SI, CS144 100A Alternators</p> <p>(Top) Heat Sink(+) Heat Sink(-) (Bottom)</p>	<p>Replaces BOSCH : 111233,111240 DELCO : 10469265,D3929</p> <p>Unit No. DELCO : 1117886,1117892,1117937</p>
 <p>RD-06A *3-50A Diodes, 3-50A Avalanche diodes *Wide Fin Gull Wing Style Heat Sinks *For use on 21SI, CS144 100A Alternators BOSCH :1-127-319-601</p> <p>(Top) Heat Sink(+) Heat Sink(-) (Bottom)</p>	<p>Replaces DELCO : 10471170,1989774,10467052,10470609,D3990...</p> <p>Unit No. DELCO : 1117895,1117903,1117927,1117932,1117957...</p>
 <p>RD-06B *6-50A Avalanche Diodes *Wide Fin Gull Wing Style Heat Sink *Heavy Duty Version of RD-06 for use on 21SI, CS144 120A Alternators</p> <p>(Top) Heat Sink(+) Heat Sink(-) (Bottom)</p>	 <p>RD-07 *6-50A Avalanche Diodes *Wide Fin Gull Wing Style Heat Sinks *CS144 Alternators</p> <p>Replaces DELCO : 10475800</p> <p>Unit No. DELCO : 10479891,10479966, 10480010,1102625</p> <p>Heat Sink(+) (Bottom) Heat Sink(-) (Top) B+(M8)</p>
 <p>RD-08 *6-50A Avalanche Diodes *Wide Fin Gull Wing Style Heat Sinks *CS144 Alternators</p> <p>Heat Sink(-) (Bottom) Heat Sink(+) (Top) B+(M8)</p>	<p>Replaces DELCO : 10472095</p> <p>Unit No. DELCO : 104080200,10479821,10479852,10479891...</p>

Brush Holder
Voltage Regulator
Repair Circuit
Rectifier
Diode Trio
Diode
Tester

Brush Holder

Voltage Regulator

Repair Circuit

Rectifier

Diode Trio

Diode

Tester

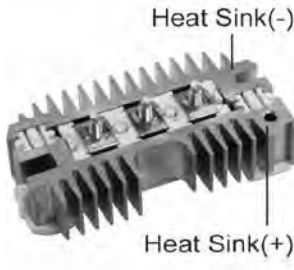

RD-09
 *6-25 Amp Diodes
 *10SI,20SI,30SI Series
 *Negative Ground Version of RD-30
 *(RD-30 is Positive Ground Version.)

Replaces
DELCO : 1852209,1875627,1891055,1971987,1984638,D3915
Unit No.
DELCO : 1100499,1102916,1102921,1102934,1102935...

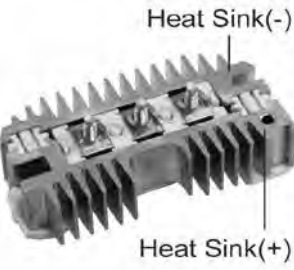

RD-09H
 *6-35 Amp Diodes
 *For DELCO 10SI, 20SI, 30SI alternators
 *Negative Ground Version of RD-30H
 *(RD-30H is Positive Ground Version.)
 *Economy Version: RD-09HA

Replaces
DELCO : 1852209,1875627,1891055,1971987,1984638,D3915
Unit No.
DELCO : 1100499,1102916,1102921,1102934,1102935...



RD-10
 *6-25 Amp Diodes

Replaces
DELCO : 3472311,7982716,7982718,DR1000
Unit No.
DELCO : 3472002,3472004,3472008,3472014,3472018...

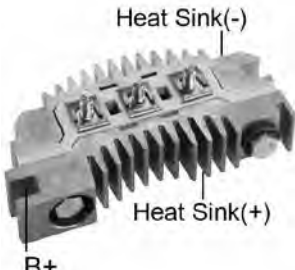

RD-10H
 *6-35 Amp Diodes

Replaces
DELCO : 3472311,7982716,7982718,DR3900



RD-10HV
 *6-50 Amp Diodes

Replaces
DELCO : 7332312
Unit No.
DELCO : 3027014,3720002,3720004,3720008,3720018...



RD-12
 *6-25 Amp Diodes
 *12SI Series

Replaces
DELCO : 1984454,D3924
Unit No.
BDELCO : 1100200,1100207,1100208,1100240,1100241...



RD-13HV
 *6-50 Amp Diodes
 *For 12SI Alternators

Replaces
DELCO : 1987061,D3986
Unit No.
DELCO : 1005425,1005428,1005493,1105425,1105428...



RD-14
 *6-25 Amp Diodes
 *15SI 70-85 Amp Series
 *Positive Ground Version
 *(RD-31 is Negative Ground Version)

Replaces
DELCO : 1975313,D3919
Unit No.
DELCO : 1100184,1100190,1100192,1101077,1101096...

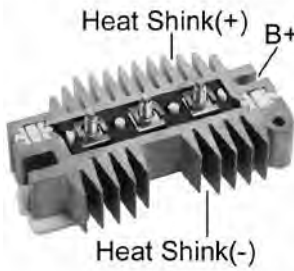

RD-14H
 *6-35 Amp Diodes
 *15SI 70-85 Amp Series
 *Positive Ground Version
 *(RD-31H is Negative Ground Version.)
 *Economy Version: RD-14HA

Replaces
DELCO : 1975313,D3919
Unit No.
DELCO : 1100184,1100190,1100192,1101077,1101096...

 <p>Heat Sink(-) Heat Sink(+)</p> <p>RD-15 *9-25 Amp Diodes *6 Pos. & 3 Neg. Diodes *17SI 97-108 Amp</p> <p>Replaces DELCO : 1985801,D3985</p> <p>Unit No. DELCO : 1105085,1105450, 1105451,1105491,1105513</p>	 <p>Heat Sink(-) Heat Sink(+)</p> <p>RD-15H *6-35 Amp Diodes *6 Pos. & 3 Neg. Diodes *17SI 97-108 Amp *Economy Version: RD-15HA</p> <p>Replaces DELCO : 1985801,D3985</p> <p>Unit No. DELCO : 1105085,1105450, 1105451,1105491,1105513</p>
 <p>Heat Sink(-) Heat Sink(+)</p> <p>RD-17 *6-25 Amp Diodes *27SI, Type 100,200,29SI,30SI Negative Ground Alternators</p>	<p>Replaces DELCO : 1875645,1892914,801816,D3982,D3983</p> <p>Unit No. DELCO : 1100077,1100078,1100080,1100095,1100177...</p>
 <p>Heat Sink(-) Heat Sink(+)</p> <p>RD-17H *6-35 Amp Diodes *27SI Type 100,200,29SI,30SI Negative Ground Alternators</p>	<p>Replaces CATERPILLAR : 9L6776 DELCO : 1875645,1892914,801816,D3982,D3983,1975645</p> <p>Unit No. DELCO : 1100077,1100078,1100080,1100095,1100177...</p>
 <p>Heat Sink(-) Heat Sink(+)</p> <p>RD-18H *6-35 Amp Diodes *Economy Version: RD-18HA</p>	<p>Replaces DELCO : 3472813,3493714,3493721,6065301 OPEL : 1205409</p> <p>Unit No. DELCO : 3472057,3472058,3472059,3472060,3472061... OPEL : 1204012,1204013,1204015,1204018,1204020...</p>
 <p>RD-18HA *6-35 Amp Diodes</p>	<p>Replaces DELCO : 3472813,3493714,3493721,6065301 OPEL : 1205409</p> <p>Unit No. DELCO : 3472057,3472058,3472059,3472060,3472061... OPEL : 1204012,1204013,1204015,1204018,1204020...</p>
 <p>RD-20HA *6-35 Amp Diodes</p> <p>Replaces DELCO : 3493008,3493417, 3493716,3493717 OPEL : 1205454</p> <p>Unit No. DELCO : 3742106,3742121,3742 130,3742134,3742137... OPEL : 1204100,1204131,1204219</p>	 <p>Heat Sink(-) Heat Sink(+) B+</p> <p>RD-21 *6-25 Amp Diodes</p> <p>Replaces DELCO : 3472820,3478627, 3478687</p> <p>Unit No. DELCO : 3472020,3472021, 3472063,3472064</p>

Brush Holder
Voltage Regulator
Repair Circuit
Rectifier
Diode Trio
Diode
Tester

Brush Holder

Voltage Regulator

Repair Circuit

Rectifier

Diode Trio

Diode

Tester



RD-21H
*6-35 Amp Diodes

Replaces
DELCO :
3472820,3478627,3478687

Unit No.
DELCO : 3472020,3472021,
3472063,3472064

Heat Sink(-)
Heat Sink(+)
B+



RD-25A
*6-50A Avalanche Diodes

Replaces
DELCO : 10492300

Heat Sink(+) Top
Heat Sink(-) Bottom
Ps

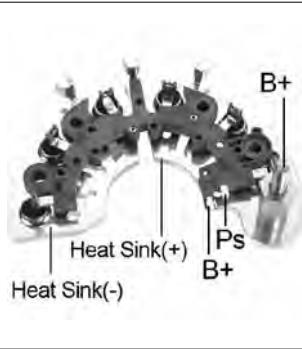

RD-26
*6-50A Avalanche Diodes

Replaces
BDELCO : 10494744

Unit No.
DELCO : 10480229,10480234,
10480241,10480244...

Heat Sink(+)
Heat Sink(-)
Ps
B+

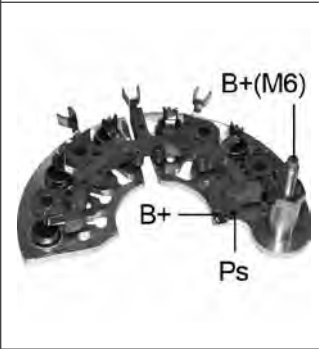

RD-26HD
*6-70A Avalanche Diodes

Replaces
DELCO : 10494503

Unit No.
DELCO : 10310982,10311493,
10464395,10464405...

B+(M6)
B+
Ps

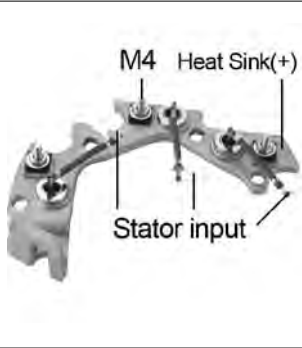

RD-27H
*6-35 Amp Diodes
*For 25SI Alternators,
Negative Ground

Replaces
DELCO : 1971670,1851437,
1969132

Unit No.
DELCO : 10459003,10459006,
1117155,1117225...

M4 Heat Sink(+)
Stator input

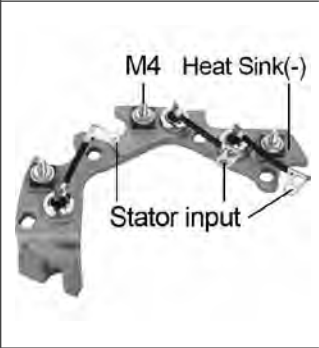

RD-28H
*6-35 Amp Diodes
*For 25SI Alternators, Positive
Ground

Replaces
DELCO : 1971867

Unit No.
DELCO : 1117232,1117235,
1117245

M4 Heat Sink(-)
Stator input



RD-29
*6-50A Avalanche Diodes

Replaces
DELCO : 10493596,3472020,
3472820,3478687

Unit No.
DELCO : 90543910,UD12AB
OPEL : 6204072

B+(M8)
W



RD-30
*6-25 Amp Diodes
*Positive Ground Version of
RD-09

Replaces
DELCO : 233195

Heat Sink(+)
Heat Sink(-)



RD-31
*6-25 Amps Diodes
*15SI 70-85 Amps Alternators
*Negative Ground Version
*(RD-14 is Positive Ground
Version.)

Replaces
DELCO : 1975313,D3919

Unit No.
DELCO : 1100184,1100190,1100192,1101077,1101096...

Heat Sink(-)
Heat Sink(+)







RD-31H
*6-35 Amps Diodes
*15SI 70-85 Amps Alternators
*Negative Ground Version
*(RD-14H is Positive Ground
Version.)
*Economy Version: RD-31HA

Replaces
DELCO : 1975313,D3919

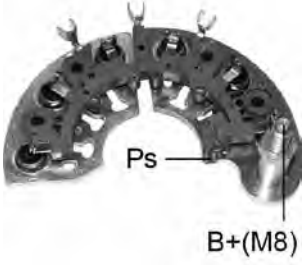
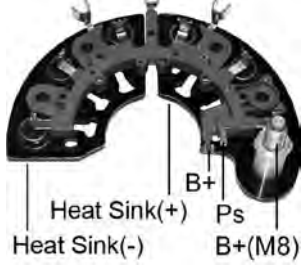
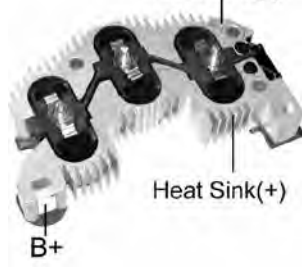
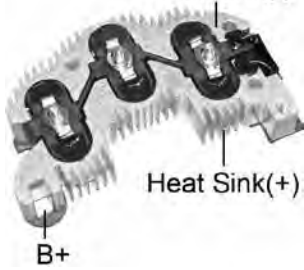
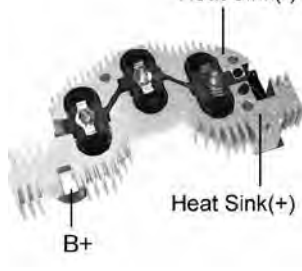
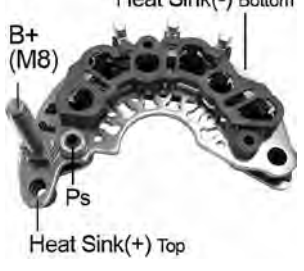
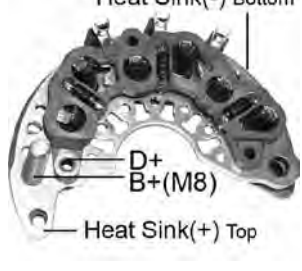
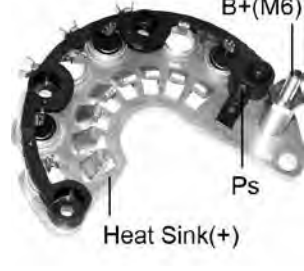
Unit No.
DELCO : 1100184,1100190,1100192,1101077,1101096...

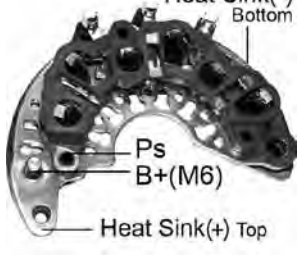
Heat Sink(-)
Heat Sink(+)

 <p>RD-33 *6-35A Avalanche Diodes *M8 Battery Post</p> <p>Replaces DELCO : 19055072</p> <p>Unit No. DELCO : 10333165,10442783,10333166,10442782</p>	 <p>RD-33HD *6-50A Avalanche Diodes *M8 Battery Post</p> <p>Unit No. DELCO : 10346705</p>
 <p>RD-35 *35SI Series *6-70A Avalanche Diodes</p> <p>Replaces DELCO : 10511353</p>	 <p>RD-35A *23SI, 33SI, 34SI Series *For 24V System *6-70A(38-43V) Avalanche Diodes</p> <p>Replaces DELCO : 10501635,10512366</p> <p>Unit No. DELCO : 19011004,19011015,19011019</p>
 <p>RD-36 *6-70A Avalanche Diodes *36SI Series</p> <p>Replaces DELCO : 10512371</p>	 <p>RD-37 *6-35A Avalanche Diodes *M8 Battery Post</p> <p>Replaces GM : 96540542,96838439</p>
 <p>RD-39H *6-35A Avalanche Diodes *M8 Battery Post</p> <p>Replaces DELCO : 1861166 SUZUKI : 31400-85Z00, 31400-85Z01</p>	 <p>RD-40H *M6 Battery Post *3-70A Avalanche Diodes *Same as RD-40HA but w/o S.R.E frame *Regitar No.: RD-40HS</p> <p>Replaces DELCO : 10503581,10510904</p> <p>Unit No. DELCO : 10392759,15200109,15200268,15263858</p>
 <p>RD-40HA *150mm OD *6-70A Avalanche Diodes *M6 Battery Post *Negative & Positive Assembly *Same as RD-40H but w/ S.R.E. frame *Regitar No.: RD-40H</p>	<p>Replaces DELCO : 10503581,10510904</p> <p>Unit No. DELCO : 10392759,15200109,15200110,15200268...</p>
 <p>RD-41 *6-50A Avalanche Diodes *M6 Battery Post</p> <p>Unit No. DELCO : 96408588 SUZUKI : 31400-85Z00, 31400-85Z01</p>	 <p>RD-44 *M8 Battery Post *3-50A Avalanche Diodes *Positive Rectifier</p> <p>Unit No. GM : 13500582,13579666,13979667,13579668...</p>

Brush Holder

Voltage Regulator

Repair Circuit

Rectifier

Diode Trio

Diode

Tester

Brush Holder

Voltage Regulator

Repair Circuit

Rectifier

Diode Trio

Diode

Tester

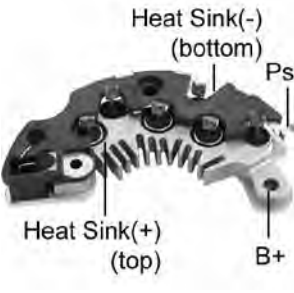

RD-95A
 *6-60A Avalanche Diodes
 *For CS121,CS130 Series Alternators

Replaces
 DELCO : 1989658,D3991

Unit No.
 DELCO : 1101227,1101266,1101267,1101271,1101465...

Labels: Heat Sink(-) (bottom), Ps, Heat Sink(+) (top), B+

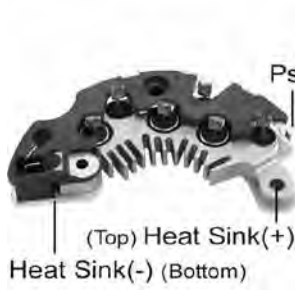

RD-95HD
 *6-70A Avalanche Diodes
 *For CS121,CS130 Series Alternators

Replaces
 DELCO : 1989658,D3991

Unit No.
 DELCO : 1101227,1101266,1101267,1101271,1101465...

Labels: (Top) Heat Sink(+), Heat Sink(-) (Bottom), Ps

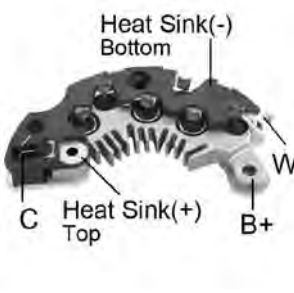

RD-96
 *6-50A Avalanche Diodes

Replaces
 DELCO : 1989658,D3991,10456401,10457236,10457690...

Unit No.
 DELCO : 1101227,1101266,1101267,1101271,1101465...

Labels: Heat Sink(-) Bottom, C, Heat Sink(+) Top, B+, W



RD-97A
 *6-50A Avalanche Diodes
 *M8 x 36.5mm Battery Post w/14mm Thread
 *For CS130D Series

Replaces
 DELCO : 10475758,CS130D

Unit No.
 DELCO : 10463443,10479981,10479984,10480017...

Labels: B+(M8) W



RD-97B
 *6-50A Avalanche Diodes
 *M8 x 32.5mm Battery Post w/11mm Thread

Replaces
 DELCO : 10475758,CS130D

Unit No.
 DELCO : 10463443,10479981,10479984,10480017...

Labels: B+(M8) W



RD-97D
 *6-50A Avalanche Diodes
 *M6 x 30.8mm Battery Post

Replaces
 DELCO : 10491097,10492837,10492838

Unit No.
 DELCO : 10479214,10480190

Labels: Heat Sink(-) Bottom, Ps, Heat Sink(+) Top, B+(M6)



RD-97HD
 *6-70A Avalanche Diodes
 *For CS130D Alternators

Replaces
 DELCO : 10475758

Unit No.
 DELCO : 10463443,3211008,3211023,3211025...

Labels: B+(M8) W



RD-97HV
 *6-50A Avalanche Diode Chips
 *For CS130D Alternators

Replaces
 DELCO : 10475758

Unit No.
 DELCO : 10463443,3211008,3211023,3211025...

Labels: B+(M8) W



RD-98A
 *6-50A Avalanche Diodes
 *Same as RD-97A but w/o Battery Post

Replaces
 DELCO : 10475758,CS130D

Unit No.
 DELCO : 10463443,10479981,10479984,10480017...

Labels: W



RD-99
 *M8 Battery Post
 *6-50A Avalanche Diodes
 *For CS121,CS130 Series

Replaces
 DELCO : 10475758,10491097,10492838

Unit No.
 DELCO : 10463443,3122026,3211008,3211023...

Labels: B+(M8), C



RN-01
 *103mm OD
 *M6 Battery Post
 *8-50 Amp Diodes
 *With Mounting Hole for Ground Strap

Replaces
DENSO : 021580-3640,021580-4660,021580-4840...
Unit No.
DENSO : 0121000-3000,0121000-3100,0121000-3300...

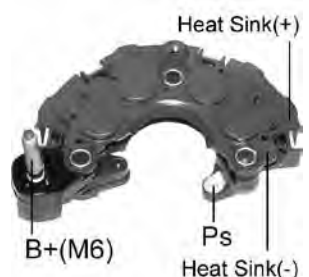

RN-01P
 *103mm OD
 *M6 Battery Post
 *8-35A Avalanche Press-fit Diodes
 *With Mounting Hole for Ground Strap

Unit No.
DENSO : 100211-8230,100211-8320,100211-8370...

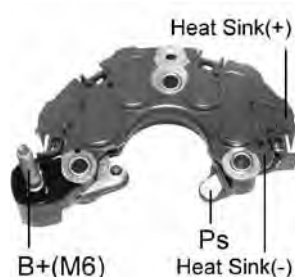

RN-01PL
 *103mm OD
 *M6 Battery Post
 *8-35A Avalanche Press-fit Diodes
 *Aluminum Heat Sinks
 *With Mounting Hole for Ground Strap

Unit No.
DENSO : 100211-8230, 100211-8320,100211-8370...



RN-02
 *113mm OD
 *M6 Battery Post
 *With Mounting Hole for Ground Strap
 *8-50 Amp Diodes

Replaces
DENSO : 021580-4820
Unit No.
CHRYSLER : 5233599,5233608,5233660,5234651
DENSO : 121000-4000,121000-4010,121000-4030...



RN-03
 *103mm OD
 *M6 Battery Post
 *With Mounting Hole for Ground Strap
 *8-50 Amp Diodes

Replaces
DENSO : 021580-3830,021580-4080,021580-4480...
Unit No.
DENSO : 100211-5110,100211-5150,100211-5270...
GM : 94847129
TOYOTA : 27060-16230,27060-42030,27060-0D010

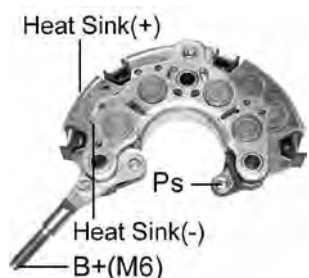

RN-03PL
 *103mm OD
 *M6 Battery Post
 *With Mounting Hole for Ground Strap
 *8-50 Amp Press-fit Diodes
 *Aluminum Heat Sinks

Replaces
DENSO : 021580-3830,021580-4080,021580-4480...
HONDA : 31127-PT0-003
TOYOTA : 27357-16310,27357-55080,27357-62040...
Unit No.
DENSO : 100211-5110,100211-5150,100211-5270...
GM : 94847129
TOYOTA : 27060-16230,27060-42030



RN-04
 *103mm OD
 *M8 Battery Post
 *With Mounting Hole for Ground Strap
 *8-50 Amp Diodes

Replaces
DENSO : 021580-4850
Unit No.
DENSO : 100211-8620, 100211-8630



RN-05
 *103mm OD
 *M8 Battery Post
 *With Mounting Hole for Ground Strap
 *8-50 Amp Diodes

Unit No.
DENSO : 100211-2400, 100211-5450

Brush Holder

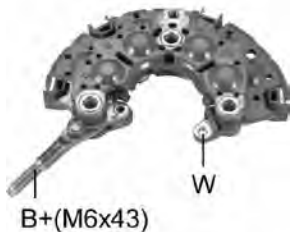

RN-08
 *113mm OD
 *M6 Battery Post
 *8-50 Amp Diodes
 *Similar to RN-11
 *With Mounting Hole for Ground Strap

Unit No.
DENSO : 121000-4230,121000-4400,102211-0920
TOYOTA : 27060-28160

Voltage Regulator



RN-10
 *113mm OD
 *M8 Battery Post
 *With Mounting Hole for Ground Strap
 *8-50 Amp Diodes

Replaces
DENSO : 021580-4250,021580-4590
HONDA : 31127-PY3-0030
Unit No.
DENSO : 100211-6160,100211-6170
HONDA : 31100-PY3-003

Repair Circuit

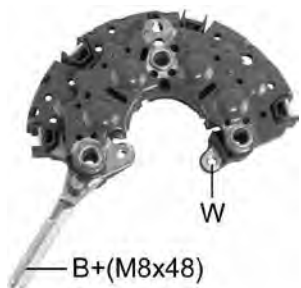

RN-11
 *113mm OD
 *M8 Battery Post
 *With Mounting Hole for Ground Strap
 *8-50 Amp Diodes

Replaces
DENSO : 021580-3750,021580-3990,021580-4040...

Rectifier



RN-12
 *100mm OD
 *M6 Battery Post
 *8-50 Amp Diodes

Replaces
DENSO : 021580-2511,021580-2512,021580-2510...
ISUZU : 8-94125884-0
TOYOTA : 27357-70081
Unit No.
DENSO : 0121000-2500,100211-1070,100211-7780...
ISUZU : 8-97027-568-0

Diode Trio

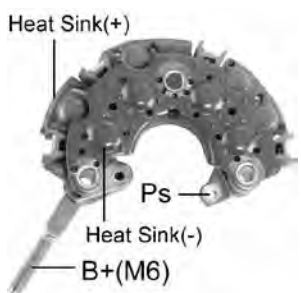

RN-13
 *100mm OD
 *M6 Battery Post
 *8-50 Amp Diodes

Replaces
DENSO : 021580-2160,021580-2230
TOYOTA : 27060-72010,27357-63020
Unit No.
DENSO : 100211-100,100211-1000,100211-1001...
HONDA : 31100-PD2-024,31100-PD6-014...
ISUZU : 8-94131-357-2,8-94408-674-0
TOYOTA : 27060-16010,27060-16012,27060-16080...

Diode

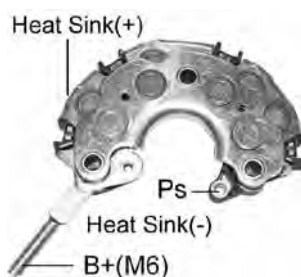

RN-13PL
 *100mm OD
 *M6 Battery Post
 *8-50 Amp Press-fit Diodes
 *Aluminum Heat Sinks

Replaces
DENSO : 021580-2160,021580-2230
TOYOTA : 27060-72010,27357-63020
Unit No.
DENSO : 100211-100,100211-1000,100211-1001...
HONDA : 31100-PD2-024,31100-PD6-014...
ISUZU : 8-94131-357-2,8-94408-674-0
TOYOTA : 27060-16010,27060-16012,27060-16080...

Tester

**RN-14**

- *100mm OD
- *M6 Battery Post
- *8-50 Amp Diodes

Replaces

DENSO : 021580-4120,021580-4490,021580-3680...
 TOYOTA : 27357-74120,27357-74290

Unit No.

CHRYSLER : 5233418,5233449,5233672
 DENSO : 0121000-2430,0121000-2680,0121000-3000...

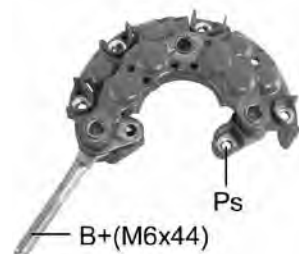
**RN-15**

- *90mm OD
- *M6 Battery Post
- *8-50 Amp Diodes

Replaces

DENSO : 021580-3130,021580-3340,021580-4310...
 TOYOTA : 27375-72150,27357-72120

Unit No.

DAIHATSU : 27060-87706
 DENSO : 100211-1430,100211-1550,100211-1560...
 ISUZU : 8-94449-781-1

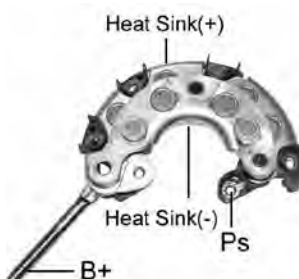
**RN-15PL**

- *90mm OD
- *M6 Battery Post
- *8-50 Amp Press-fit Diodes
- *Aluminum Heat Sinks

Replaces

DENSO : 021580-3130
 TOYOTA : 27375-72150

Unit No.

DAIHATSU : 27060-87706
 DENSO : 100211-1430,100211-1550,100211-1560...
 ISUZU : 8-94449-781-1

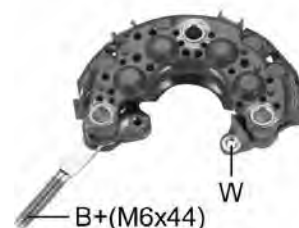
**RN-16**

- *90mm OD
- *M6 Battery Post
- *8-50 Amp diodes

Replaces

DENSO : 021580-2250,021580-2260
 TOYOTA : 27375-6340

Unit No.

DENSO : 100211-1200,100211-1210,100211-1230...
 HONDA : 31100-PEO-003
 ISUZU : 8-94413-621-0
 TOYOTA : 27060-10011,27060-10060,27060-10061...

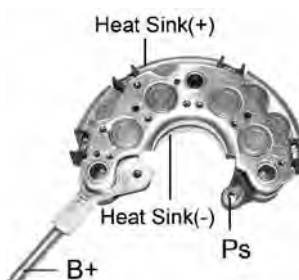
**RN-16PL**

- *90mm OD
- *M6 Battery Post
- *8-50 Amp Press-fit Diodes
- *Aluminum Heat Sinks

Replaces

DENSO : 021580-2250,021580-2260
 TOYOTA : 27375-6340

Unit No.

DENSO : 100211-1200,100211-1210,100211-1230...
 HONDA : 31100-PEO-003
 ISUZU : 8-94413-621-0
 TOYOTA : 27060-10011,27060-10060,27060-10061...

**RN-17**

- *90mm OD
- *M6 Battery Post
- *8-50 Amp Diodes

Replaces

DENSO : 021580-2340,021580-2341,021580-2342
 ISUZU : 16231-64851

Unit No.

DENSO : 100211-1200,100211-1330,100211-3720
 ISUZU : 8-97137-345-2

Brush Holder

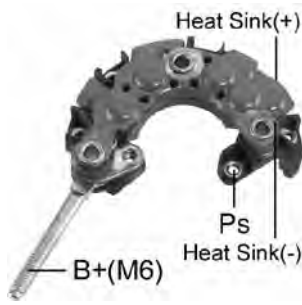

RN-18
*83mm OD
*M6 Battery Post
*8-35 Amp Diodes

Replaces
DENSO : 021580-3110
Unit No.
DENSO : 100211-454,100211-4540

Voltage Regulator



RN-19
*107mm OD
*M8 Battery Post
*8-50 Amp Diodes

Replaces
DENSO : 100211-1830,100211-2840
Unit No.
DENSO : 100211-183,100211-1830,100211-2840
TOYOTA : 27060-43100,27060-43130

Repair Circuit



RN-20
*114mm OD
*M5 Battery Post
*8-35 Amp Diodes

Replaces
DENSO : 021600-1491,021600-1531,021600-1561
TOYOTA : 27362-15070,27362-43020
Unit No.
DENSO : 100211-0530,100211-0550,100211-0560...

Rectifier

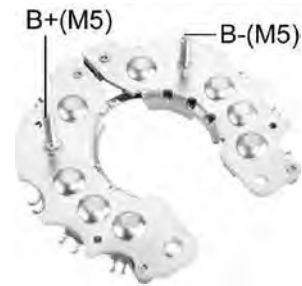

RN-22
*114mm OD
*M5 Battery Post
*8-35 Amp Diodes
*Same as RN-20 but without
Brush Holder

Replaces
DENSO : 021600-1491,021600-1531,021600-1561
TOYOTA : 27362-15070,27362-43020
Unit No.
DENSO : 100211-0530,100211-0550,100211-0560...
TOYOTA : 27060-15020,27060-28050,27060-43020...

Diode Trio



RN-24
*90mm OD
*M6 Battery Post
*8-50 Amp Diodes
Unit No.
DENSO : 100211-2460

RN-26
*83mm OD
*M6 Battery Post
*8-50 Amp Diodes
Replaces
DENSO : 021580-3890,
021580-3450
Unit No.
DENSO : 100211-1670,
100211-4640,100211-4650...





Diode

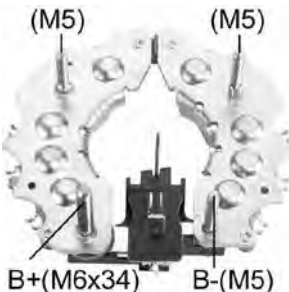
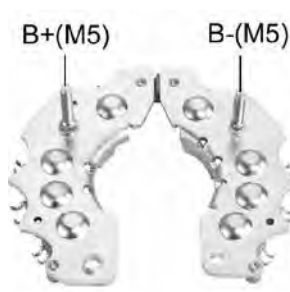

RN-29
*117mm OD
*M8 Battery Post
*12-50 Amp Diodes
Unit No.
DENSO : 421000-001,421000-
002,421000-004...

RN-30
*117mm OD
*M8 Battery Post
*12-50 Amp Diodes
Replaces
DENSO : 4210000120

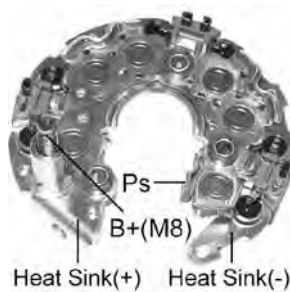
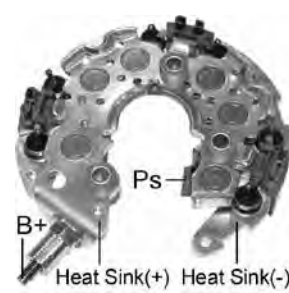
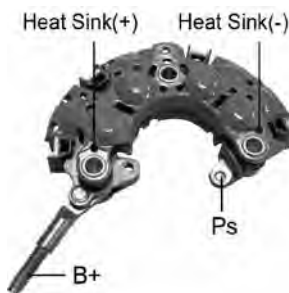
Tester

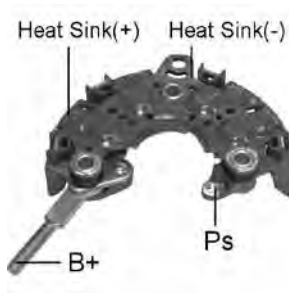
 <p>RN-31 *113mm OD *8-35 Amp Diodes</p> <p>Replaces DENSO : 021600-1840 TOYOTA : 27362-63011</p> <p>Unit No. DENSO : 021000-8270, 021000-8310,021000-8311...</p>	 <p>RN-32 *113mm OD *6-35 Amp Diodes</p> <p>Replaces DENSO : 021600-0750, 021600-1420,021600-1610</p> <p>Unit No. DENSO : 0121000-1010, 0121000-1011, 0121000-1012...</p>
 <p>RN-33 *117mm OD *M8 Battery Pos *12-50A Avalanche Diodes</p> <p>Unit No. DENSO : 10421-3090, 104210-5950 FORD : 9L3T-10300AB</p>	 <p>RN-33M *117mm OD *M8 Battery Pos *Same as RN-33 but with Low Loss Diodes</p> <p>Unit No. DENSO : 10421-3090, 104210-5950 FORD : 9L3T-10300AB</p>
 <p>RN-34 *117mm OD *M6 Battery Post *12-50A Avalanche Diodes</p>	<p>Replaces DENSO : 7060</p> <p>Unit No. DENSO : 10421-0338,104210-347,104210-420... HONDA : 31100-RZP-G01,CSF37 TOYOTA : 27060-0F040,27060-0P020,27060-31020...</p>
 <p>RN-36 *107mm OD *M6 Battery Post *6-35A Avalanche Diodes *With Mounting Hole for Ground Strap</p>	<p>Replaces DENSO : 021580-06510 ,021580-5510,021580-5560 TOYOTA : 27357-22050,27357-22200</p> <p>Unit No. DENSO : 102211-1920,102211-1990,102211-2380... TOYOTA : 27060-0H010,27060-21150,27060-22040...</p>
 <p>RN-37 *117mm OD *M8 Battery Post *7-50A Avalanche Diodes</p>	<p>Unit No. DENSO : 104210-3512,104210-3513,104210-3511 FORD : 3M5T-10300PC,3M5T-10300PD</p>
 <p>RN-38 *100mm OD *M6 Battery Post *With Mounting Hole for Ground Strap *8-50 Amp Diodes</p>	<p>Replaces DENSO : 021580-5300</p> <p>Unit No. DENSO : 102211-5013,102211-5022,102211-504... ISUZU : 29012-37800,29012-37801,89710-97800... SUZUKI : 31400-77E22,31400-77E23 TOYOTA : 27060-62190</p>

Brush Holder

Voltage Regulator

Repair Circuit

Rectifier

Diode Trio

Diode

Tester

Brush Holder



RN-39
 *117mm OD
 *M8 Battery Post
 *12-50A (19-24V) Avalanche Diodes

Unit No.
DENSO : 104210-3521,104210-3522,104210-3523
FORD : 3M5T-10300YB,3M5T-10300YC,3M5T-10300YD

Voltage Regulator



RN-40
 *83mm OD
 *M6 Battery Post
 *8-50 Amp Diodes

Replaces
DENSO : 021580-3080,101211-1250
Unit No.
CHRYSLER : 4609999AB,56041324
DENSO : 100211-1680,121000-4250
TOYOTA : 27060-0F020

Repair Circuit

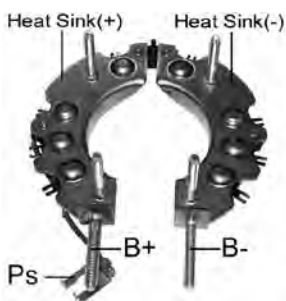

RN-41
 *114mm OD
 *M6 Battery Post
 *8-35 Amp Diodes
Replaces
DENSO : 021590-1890, 021590-1900,021590-1910...
Unit No.
DENSO : 100211-1573, 100211-2211,100211-2280...

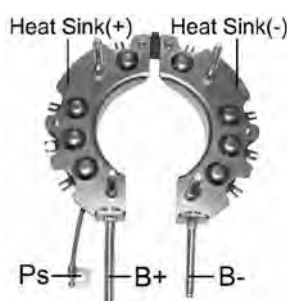

RN-41A
 *114mm OD
 *8-35 Amp Diodes
Unit No.
DENSO : 100213-2560
ISUZU : 8-97940-220-0

Rectifier

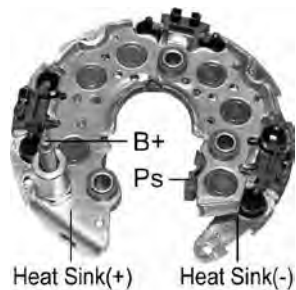

RN-44
 *117mm OD
 *M6 Battery Post
 *12-50A Avalanche Diodes
Replaces
DENSO : 021580-5920

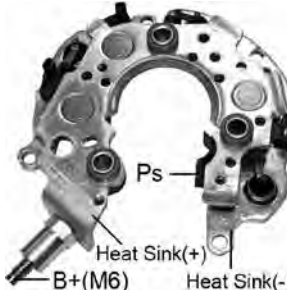

RN-45
 *105mm OD
 *M6 Battery Post
 *6-35A Avalanche Diodes
Replaces
TOYOTA : 27060-0C021, 27060-0C020
Unit No.
DENSO : 104210-9050
TOYOTA : 27060-0H090

Diode Trio

Diode



RN-45H
 *105mm OD
 *M6 Battery Post
 *6-50A Avalanche Diodes
Unit No.
DENSO : 104210-900
TOYOTA : 27060-0C020

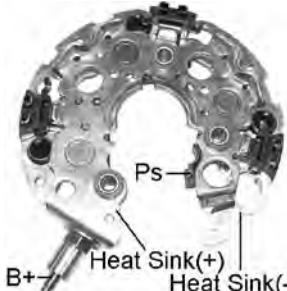

RN-46
 *117mm OD
 *M6 Battery Post
 *6-50A Avalanche Diodes
Replaces
DENSO : 021580-6610
Unit No.
DENSO : 104210-388,104210-389,104210-533...
TOYOTA : 27060-0H100,27060-28270,27060-28350...

Tester

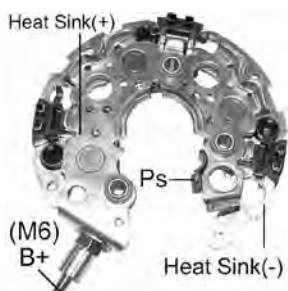

RN-46M
 *117mm OD
 *M6 Battery Post
 *Same as RN-46 but with Low Loss Diodes

Replaces
DENSO : 021580-6610
Unit No.
DENSO : 104210-388,104210-389,104210-533...
TOYOTA : 27060-0H100,27060-28270,27060-28350...



RN-47
 *117mm OD
 *M8 Battery Post
 *12-50A Avalanche Diodes
Unit No.
DENSO : 104210-400,104210-448,104210-1240
HONDA : 31100-RCB-Y02,31100-RGL-A01...
TOYOTA : 27060-50340

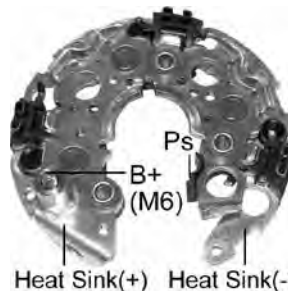

RN-48
 *117mm OD
 *M6 Battery Post
 *6-50A Avalanche Diodes
Replaces
DENSO : 021580-6490
Unit No.
DENSO : 104210-3290,104210-3291,104210-3292...
HONDA : 31100-RAA-A01,31100-RAA-A03...

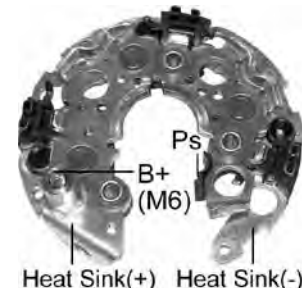

RN-48M
 *117mm OD
 *M6 Battery Post
 *Same as RN-48 but with Low Loss Diodes

Replaces
DENSO : 021580-6490
Unit No.
DENSO : 104210-3290,104210-3291,104210-3292...
HONDA : 31100-RAA-A01,31100-RAA-A03...

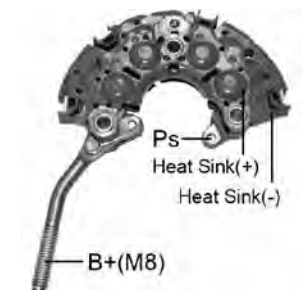

RN-49
 *113mm OD
 *With Mounting Hole for Ground Strap
 *8-50 Amp Diodes

Replaces
DENSO : 021580-4890
Unit No.
DENSO : 100211-6300,101211-7090,101211-7091...
MAZDA : KJ01-18-300,KJ01-18-300A

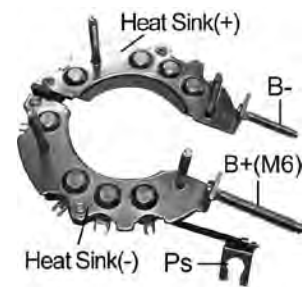

RN-50L
 *114mm OD
 *M6 Battery Post
 *8-35A Avalanche Diodes
 *Aluminum Heat Sinks
Replaces
DENSO : 021590-2050, 021590-1990
Unit No.
DENSO : 100213-0750, 100213-0760,100213-0770...

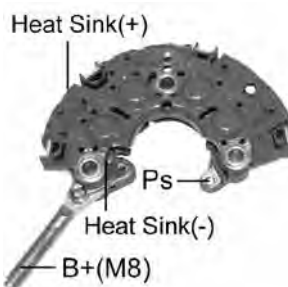

RN-51
 *113mm OD
 *M8 Battery Post
 *8-50A Avalanche Diodes
 *With Mounting Hole for Ground Strap
Replaces
DENSO : 021580-4780
Unit No.
DENSO : 100211-6420

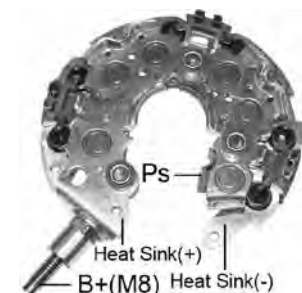

RN-53
 *117mm OD
 *M8 Battery Post
 *12-50A Avalanche Diodes

Unit No.
DENSO : 421000-0410,421000-0470,421000-0530...
TOYOTA : 104210-2930

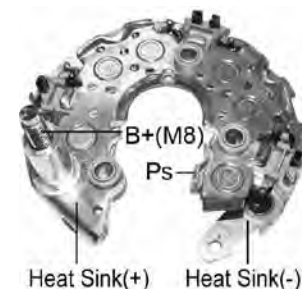

RN-54
 *117mm OD
 *M8 Battery Post
 *12-50A Avalanche Diodes

Replaces
DENSO : 03726
Unit No.
DENSO : 104210-2160,104210-4220,104210-4370...
GM : 15139480,25755840,25862643
HYUNDAI : 37300-3C200

Brush Holder

Voltage Regulator

Repair Circuit

Rectifier

Diode Trio

Diode

Tester

Brush Holder

Voltage Regulator

Repair Circuit

Rectifier

Diode Trio

Diode

Tester



RN-55
 *117mm OD
 *M8 Battery Post
 *7-50 Amp Diodes

Unit No.
CHRYSLER : 04606755AC, 04868431AF,04868431AG...
DENSO : 421000-0210, 421000-0222,421000-0223...



RN-56
 *117mm OD
 *M8 Battery Post
 *12-50A Avalanche Diodes

Unit No.
CHRYSLER : 56029915AB,56044380AH
DENSO : 421000-0150, 421000-0260,421000-0261...

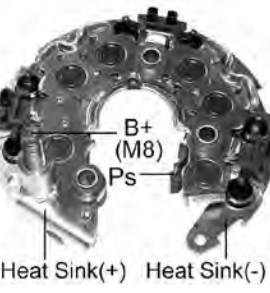

RN-56M
 *117mm OD
 *M8 Battery Post
 *Same as RN-56 but with Low Loss Diodes

Unit No.
CHRYSLER : 56029915AB,56044380AH
DENSO : 421000-0150,421000-0260,421000-0261...

Replaces
DENSO : 021580-5941

Unit No.
DENSO : 104210-4090,104210-4091,104210-3450...
FORD : 5F9T-10300BB,5F9Z-10346BA
TOYOTA : 27060-0A110



RN-57
 *117mm OD
 *M6 Battery Post
 *12-50A Avalanche Diodes

Replaces
DENSO : 021580-5941

Unit No.
DENSO : 104210-4090,104210-4091,104210-3450...
FORD : 5F9T-10300BB,5F9Z-10346BA
TOYOTA : 27060-0A110

Replaces
DENSO : 021580-5941

Unit No.
DENSO : 104210-4090,104210-4091,104210-3450...
FORD : 5F9T-10300BB,5F9Z-10346BA
TOYOTA : 27060-0A110

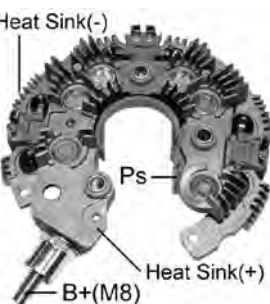

RN-59
 *134mm OD
 *M8 Battery Post
 *12-50A Avalanche Diodes

Replaces
DENSO : 785

Unit No.
DENSO : 104210-6140
TOYOTA : 27060-38050

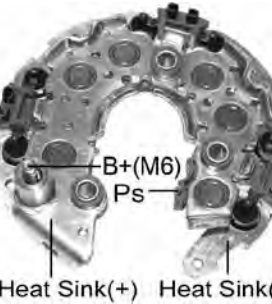

RN-60
 *117mm OD
 *M6 Battery Post
 *12-50A Avalanche Diodes

Unit No.
DENSO : 104210-589
HONDA : 31100-R40-A01



RN-63
 *134mm OD
 *M8 Battery Post
 *12-50A Avalanche Diodes

Unit No.
DENSO : 104210-6010, 104210-6101,104210-600...
FORD : 7C3T-10300EE
GM : 15817893,15868747
SUZUKI : 31400-78J10

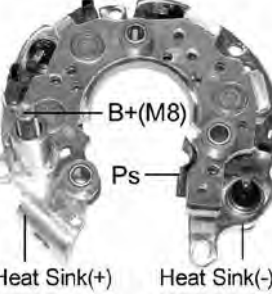

RN-64
 *105mm OD
 *M8 Battery Post
 *6-50A Avalanche Diodes

Unit No.
DENSO : 104210-9031, 104210-2341
TOYOTA : 8973697161





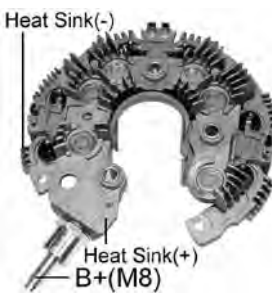

RN-66
 *113mm OD
 *M8 Battery Post
 *With Mounting Hole for Ground Strap
 *8-50 A Avalanche Diodes

Unit No.
HYUNDAI : 37300-3C170
POONG SUNG : 02131-9330

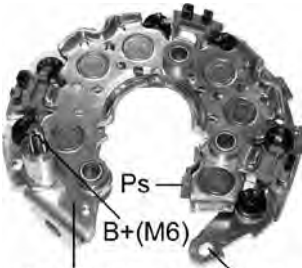
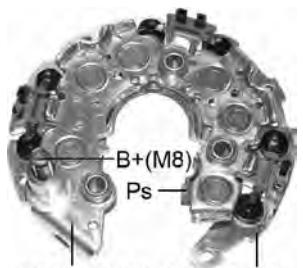
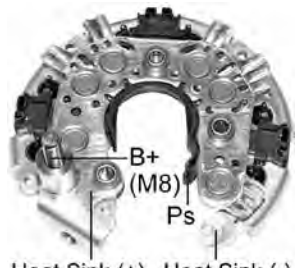

RN-67
 *134mm OD
 *M8 Battery Post
 *12-50A Avalanche Diodes

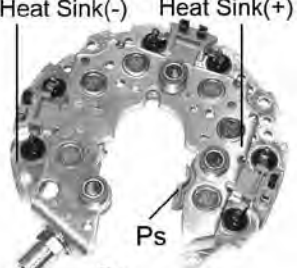
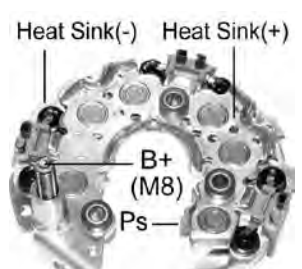
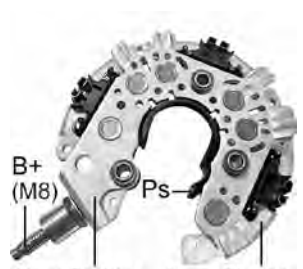
Unit No.
DENSO : 104210-6340, 104210-6180,104210-6182...

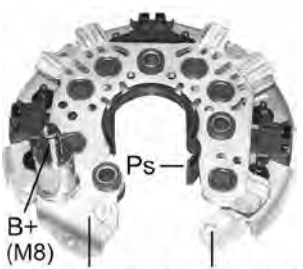
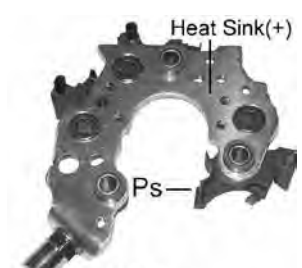
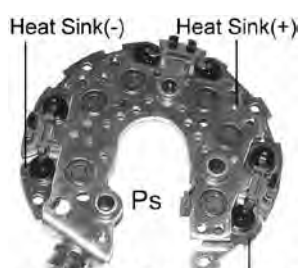
 <p>RN-69 *117mm OD *M6 Battery Post *12-50A Avalanche Diodes</p> <p>Unit No. DENSO : 104210-1530 HONDA : 31100-RTA-003, 31100-RTA-013...</p> <p>Ps B+(M6) Heat Sink(+) Heat Sink(-)</p>	 <p>RN-70 *117mm OD *M8 Battery Post *12-50A Avalanche Diodes</p> <p>Unit No. DENSO : 104210-3970, 104210-3971,104210-2460 HONDA : 31100-RFE-003, 31100-RFE-0130</p> <p>B+(M8) Ps Heat Sink(+) Heat Sink(-)</p>
 <p>RN-71 *132mm OD *M8 Battery Post *12-50A Avalanche Diodes</p> <p>Unit No. DENSO : 421000-7041</p> <p>B+(M8) Ps Heat Sink (+) Heat Sink (-)</p>	 <p>RN-72 *117mm OD *M8 Battery Post *12-50A Avalanche Diodes</p> <p>Unit No. DENSO : 104210-8850 FORD : D2BT-10300AA</p> <p>Heat Sink(-) Ps B+ Heat Sink(+)</p>
 <p>RN-74 *134mm OD *M8 Battery Post *12-50A Avalanche Diodes</p> <p>Unit No. DENSO : 104210-6250, 104210-6040,104210-6040</p> <p>Ps Heat Sink(+) B+(M8) Heat Sink(-)</p>	 <p>RN-76 *117mm OD *12-50 Amp Diodes</p> <p>Unit No. DENSO : 104211-3200, 104211-3201,104211-3202... TOYOTA : 27060-0T340</p> <p>Heat Sink(-) Heat Sink(+) Ps B+</p>
 <p>RN-77 *117mm OD *M6 Battery Post *12-50A Avalanche Diodes</p> <p>Unit No. DENSO : 104211-8000</p> <p>Heat Sink(-) Heat Sink(+) B+(M8) Ps</p>	 <p>RN-78 *132mm OD *M8 Battery Post *12-50A Avalanche Diodes</p> <p>Unit No. DENSO : 104210-6870</p> <p>B+(M8) Ps Heat Sink(+) Heat Sink(-)</p>
 <p>RN-81 *124mm OD *M8 Battery Post *12-50A Avalanche Diodes</p> <p>Unit No. DENSO : 104211-3470</p> <p>Heat Sink(-) Heat Sink(+) Ps (M8) B+ Heat Sink(-)</p>	 <p>RN-82 *132mm OD *M8 Battery Post *12-50A Avalanche Diodes</p> <p>Unit No. DENSO : 104210-6770, 104210-6771</p> <p>Ps B+(M8) Heat Sink(+) Heat Sink(-)</p>
 <p>RN-83</p> <p>Unit No. DENSO : MA104210-9790</p> <p>Heat Sink(+) Ps B+(M6)</p>	 <p>RN-84</p> <p>Unit No. DENSO : 104211-8210, 104211-8211</p> <p>Heat Sink(-) Heat Sink(+) Ps B+(M8) Heat Sink(-)</p>

Brush Holder
 Voltage Regulator
 Repair Circuit
 Rectifier
 Diode Trio
 Diode
 Tester

Brush Holder

Voltage Regulator

Repair Circuit



Rectifier

Diode Trio

Diode

Tester

<p>RN-85</p> <p>Unit No. DENSO : 104211-3750, 104211-3761 TOYOTA : 27060-31340, 27060-0P350</p> <p>PICTURE IS NOT AVAILABLE</p>	<p>RN-86</p> <p>Unit No. TOYOTA : 27060-0C170</p> <p>PICTURE IS NOT AVAILABLE</p>
<p>RN-87 *12-50A Avalanche Diodes</p> <p>Unit No. DENSO : 104211-8380</p> <p>PICTURE IS NOT AVAILABLE</p>	<p>RN-88</p> <p>Unit No. DENSO : 104210-3910</p> <p>PICTURE IS NOT AVAILABLE</p>

 <p>RI-07H *6-35 Amp Diodes *110mm OD</p>	<p>Replaces BOSCH : 9-121-337-337 FEMSA : 28466-6 LUCAS : UBB600 TOSHIBA : 7G2,7H4 Unit No. BOSCH : 9-120-330-227,9-120-330-292...</p>
 <p>RI-08H *6-35 Amp Diodes *110mm OD</p>	<p>Replaces BOSCH : 9-121-337-324 FEMSA : 25945-9 TOSHIBA : 7M2 Unit No. BOSCH : 9-120-331-802,9-120-331-805... FEMSA : ALS12N14,ALS12N55,ALS24N20,ALS24N5... FIAT : 4376376,4474933 MAGNETI MARELLI : 63303213,63303780</p>
 <p>RI-09H *6-35 Amp Diodes *110mm OD</p> <p>Replaces BOSCH : 9-121-337-323 FEMSA : 25945-8 Unit No. BOSCH : 9-120-331-847 FEMSA : ALS12N47</p>	

- Brush Holder
- Voltage Regulator
- Repair Circuit
- Rectifier
- Diode Trio
- Diode
- Tester

Brush Holder

Voltage Regulator

Repair Circuit

Rectifier

Diode Trio

Diode

Tester

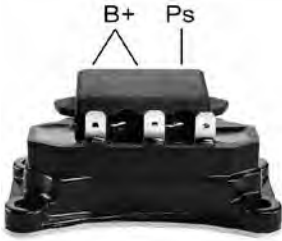

RF-01

*6-25 Amp Diodes
 *FORD 2G series 75-80 AMP IR/EF Alternators
 *40-65A Internally Regulated Alternators

Replaces

FORD : E43Z-10304A,E43Z-10335A
 MOTORCRAFT : GY-1351

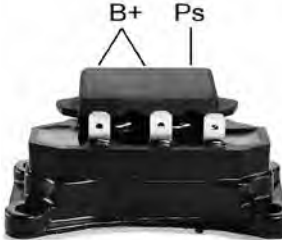

RF-02

*6-35 Amp Diodes
 *Copper Heat Sink
 *FORD 2G series 75-80 AMP IR/EF Alternators

Replaces

FORD : E6DZ-10304, E6DZ-10304A
 MOTORCRAFT : GY-1360

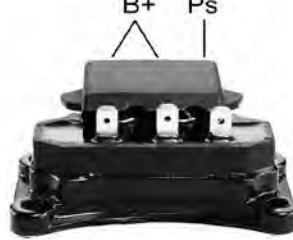

RF-03

*6-50 Amp Diodes
 *Copper Heat Sink



RF-043

*8-35 Amp Diodes
 *133mm OD
 *W/Drop Down Leads
 *Ford 3G Series 75-95 Amp IR/IF Alternators

Replaces

FORD : F5AZ-10304BA

Unit No.

FORD : 98AB-10300EB, 98AZ-10346EA,98BB-10300CC...



RF-043HV

*8-70 Amp Diodes
 *133mm OD
 *W/Drop Down Leads
 *Ford 3G Series 75-95 Amp IR/IF Alternators

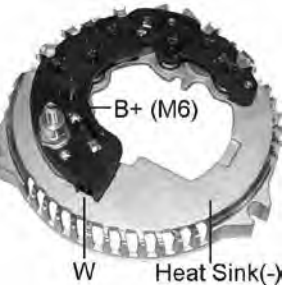

RF-053

*8-50 Amp Diodes
 *147mm OD
 *W/Drop Down Leads
 *Ford 3G Series 115-130 Amp IR/IF Alternators

Replaces

FORD : F5AZ-10304AA,FODU-10A366DAIP

Unit No.

FORD : 94BB-10300AE,96BB-10300AB,97BB-10300AC...

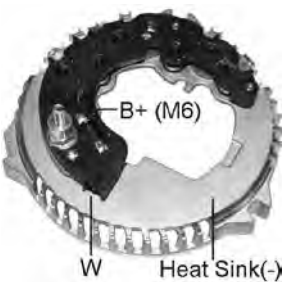

RF-053HV

*8-70A Avalanche Diodes
 *147mm OD
 *W/Drop Down Leads
 *Ford 3G Series 115-130 Amp IR/IF Alternators

Replaces

FORD : F5AZ-10304AA

Unit No.

FORD : F0DF-10300BA,F0DU-10300BC,F0DZ-10346B...

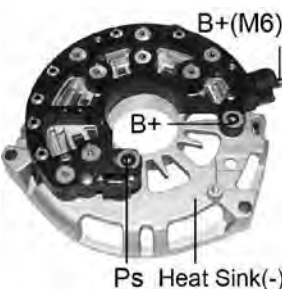

RF-063







*133mm OD
 *8-50 Amp Diodes
 *W/Drop Down Leads
 *Ford 4G Series IR/IF Alternators

Replaces

FORD : F5OZ-10300FA,F6DU-10300BB,F6LU-10300CA...
 MOTORCRAFT : GL-331

Unit No.

FORD : F50U-10300FC,F5DU-10300DB,F5OU-10300FA...

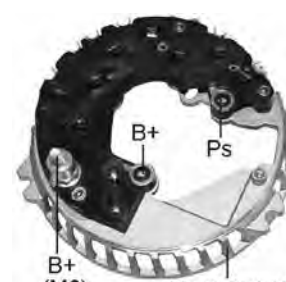
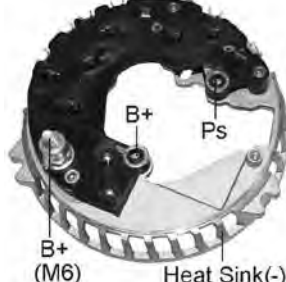
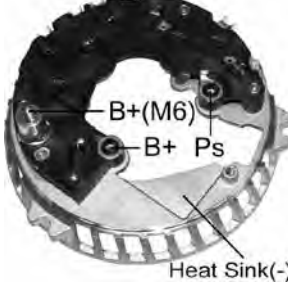
 <p>RF-063HV *133mm OD *8-70A Avalanche Diodes *W/Drop Down Leads *Ford 4G Series IR/IF Alternators</p> <p>Unit No. FORD : F50U-10300FC,F5DU-10300DB,F5OU-10300FA...</p>	 <p>RF-07H *6-35 Amp Diodes *Ford 1G Series ER/EF Alternators</p> <p>Replaces FORD : D6AZ10304A, D9VY10304A, GY1306A</p> <p>Unit No. FORD : GY1306A</p>
 <p>RF-07HV *6-50 Amp Diodes *Ford 1G Series ER/EF Alternators</p> <p>Replaces MOTORCRAFT : GY-1306A</p>	 <p>RF-08H *6-35 Amp Diodes *Ford 1G Series ER/EF Alternators</p> <p>Replaces DELCO : A3900 FORD : D6AZ-10304A, D9VY-10304A MOTORCRAFT : GY-1306A, GY-1327</p>
 <p>RF-08HV *6-70 Amp Diodes *Ford 1G Series ER/EF Alternators</p>	<p>Replaces DELCO : A3900 FORD : D6AZ-10304A MOTORCRAFT : GY-1306A</p> <p>Unit No. DELCO : A3900 FORD : D64Z-10304A, D9VY-10304A MOTORCRAFT : GY-1306A, GY-1327</p>
 <p>RF-09H *6-35 Amp Diodes *Ford 1G Series 70 Amp ER/EF Alternators</p> <p>Replaces FORD : D2OZ-10304A MOTORCRAFT : GY-1026</p> <p>Unit No. FORD : GL215</p>	 <p>RF-09HV *6-50 Amp Diodes *Ford 1G Series 70 Amp ER/EF Alternators</p> <p>Replaces FORD : D2OZ-10304A, F0TZ-10304A, GY-1026-A MOTORCRAFT : GY-1026A</p> <p>Unit No. FORD : D9AF-10300CA, E3TF-10300AB, E4LF-10300CA...</p>
 <p>RF-103 *136mm OD *8-50 Amp Diodes *W/Drop Down Leads *Ford 6G Series 105 Amp IR/IF Alternators</p>	<p>Replaces FORD : F8WU10A366AAIP, F8WU10A366AA, F8WU10A366AA1P</p> <p>Unit No. FORD : 1S41-10300BB, 4C3Z-10346AA, 98AB-10300FC...</p>
 <p>RF-103HV *136mm OD *8-70A Avalanche Diodes *W/Drop Down Leads *Ford 6G Series 105 Amp IR/IF Alternators</p> <p>Replaces FORD : F8WU-10A366AAIP</p> <p>Unit No. FORD : 1S41-10300BB, 4C3Z-10346AA, 98AB-10300FC...</p>	 <p>RF-113 *136mm OD *8-50 Amp Diodes *W/Drop Down Leads *Ford 6G Series IR/IF Alternators</p> <p>Replaces FORD : 233208</p> <p>Unit No. FORD : 98AB-10300EB, 98AZ-10346EA, 98BB-10300CC...</p>

Brush Holder

Voltage Regulator

Repair Circuit

Rectifier

Diode Trio

Diode

Tester

Brush Holder

Voltage Regulator

Repair Circuit

Rectifier

Diode Trio

Diode

Tester

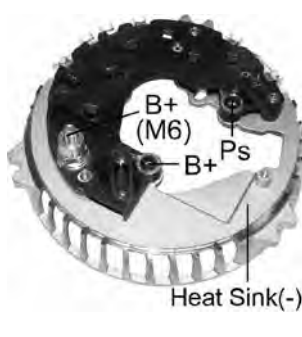

RF-123
 *149mm OD
 *8-50 Amp Diodes
 *W/Drop Down Leads
 *Ford 6G Series IR/IF Alternators

Replaces
BFORD : F8AU10A366AA,F8AU10A366AAIP

Unit No.
FORD : 3W1U-10300BB,3W1Z-10346BARM...

Heat Sink(-)



RF-123HV
 *149mm OD
 *8-70A Avalanche Diodes
 *W/Drop Down Leads
 *Ford 6G Series IR/IF Alternators

Replaces
FORD : F8AU-10A366AAIP

Unit No.
FORD : 3W1U-10300BB, 3W1Z-10346BARM...

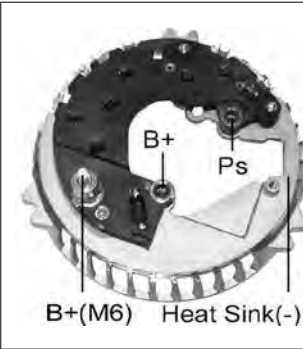

RF-124
 *149mm OD
 *8-50 Amp Diodes
 *Ford 6G Series 135-140 Amp IR/IF Alternators

Unit No.
FORD : 5C3T-10300BA, 5C3Z-10346BA,6C3T-10300BA...

B+(M6) Heat Sink(-)

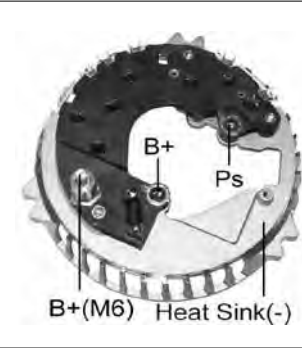

RF-125
 *149mm OD
 *8-50A Avalanche Diodes
 *Ford 6G Series IR/IF Alternators

Unit No.
FORD : 3L74-10300AA, 3L74-10300BA,3L74-10300BB...

B+(M6) Heat Sink(-)

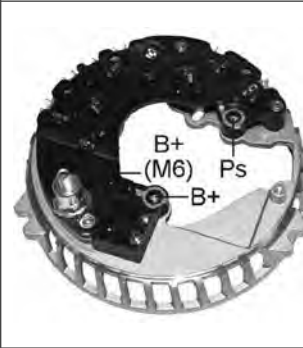

RF-133
 **Replace RF-13
 *131mm OD
 *M6 Battery Post
 *6-50 Amp Diodes
 *W/Drop Down Leads

Unit No.
FORD : 1L8U-10300CE, 1L8Z-10346CB,GL453,GL463...

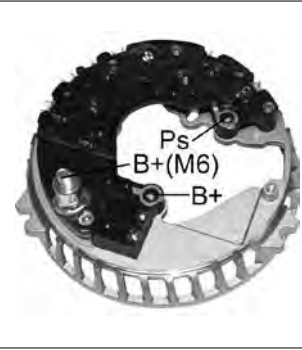

RF-143
 **Replace RF-14
 *131mm OD
 *M6 Battery Post
 *6-50 Amp Diodes
 *W/Drop Down Leads

Unit No.
FORD : 1L8Z-10346CB

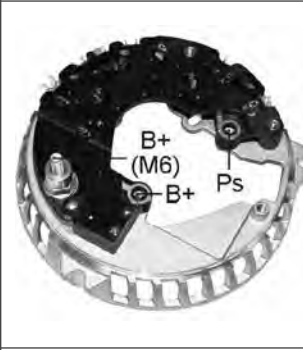

RF-153
 *131mm OD
 *M6 Battery Post
 *6-50 Amp Diodes
 *W/Drop Down Leads
 *Ford 6G Series IR/IF Alternators

Unit No.
FORD : 1L8Z-10346AB



RF-16HD
 *6-70 Amp Diodes

Replaces
FORD : D3VY-10304A, E9DZ-10304A,F0HZ-10304A
MOTORCRAFT : GY-1302, GY-1302B,GY-1345A,GY-1346

B- B+

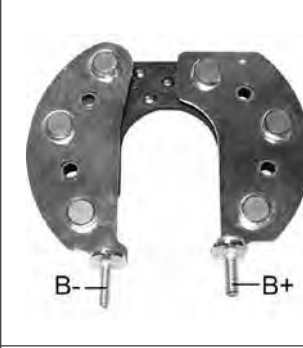

RF-16HV
 *6-50 Amp Diodes

Replaces
FORD : D3VY-10304A, E9DZ-10304A,F0HZ-10304A
MOTORCRAFT : GY-1302, GY-1302B,GY-1345A,GY-1346

B- B+



RF-18HV
 *8-50A Avalanche Diodes
 *M6 Battery Post

Unit No.
FORD : 1S7T-10300BA, 1S7T-10300BB,1S7T-10300BC...

B+ Ps

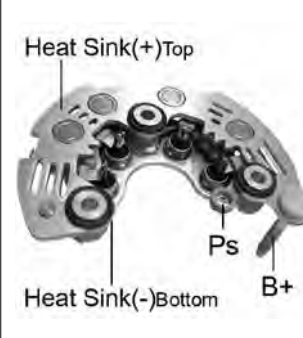

RF-19H
 *M6 Battery Post
 *8-50 Amp Diodes

Unit No.
FORD : CX1FA
VALEO : 3N2110300BB

Heat Sink(+)Top
 Heat Sink(-)Bottom
 Ps B+

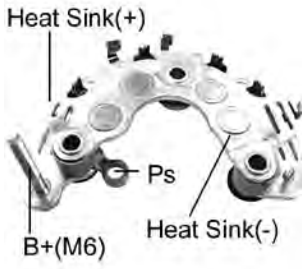
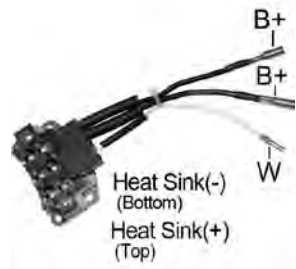
 <p>RF-22HV *105mm OD *M6 Battery Post *8-50A Avalanche Diodes</p> <p>Unit No. FORD : 2S6T-10300FA, 2S6T-10300FB VISTEON : 20-150-01001</p>	 <p>RF-23W *6-50 Amp Diodes *FORD 2G Series 40-80A IR/EF Alternators</p> <p>Replaces FORD : E43Z-10304A, E6DZ-10304A,E6DZ10304, GY1351...</p>

- Brush Holder
- Voltage Regulator
- Repair Circuit
- Rectifier
- Diode Trio
- Diode
- Tester

Brush Holder

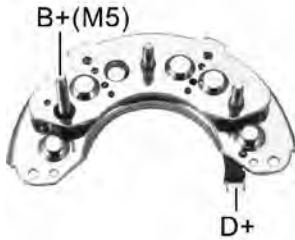

RH-01
 *118mm OD
 *Aluminum Heat Sink
 *M5 Battery Post w/diode Trio
 *6-35 Amp Diodes

Replaces
HITACHI : L150-13203,L160-3320
NISSAN : 23230-06500,23230-Q4601
SUBARU : 49534-7101

Unit No.
HITACHI : LR155-15C,LR160-104,LR160-105,LR160-109...
NISSAN : 23100-29R00,23100-D0201,23100-D0800...
SUBARU : 23700-AA00Q,23700-AA020,23700-AA160...

Voltage Regulator

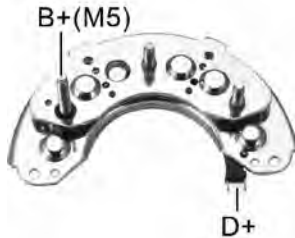

RH-01C
 *118mm OD
 *Copper Heat Sinks
 *M5 Battery Post w/diode Trio
 *6-35 Amp Diodes

Replaces
HITACHI : L150-13203,L160-3320
NISSAN : 23230-06500,23230-Q4601
SUBARU : 49534-7101

Unit No.
HITACHI : LR155-15C,LR160-104,LR160-105,LR160-109...
NISSAN : 23100-29R00,23100-D0201,23100-D0800...
SUBARU : 23700-AA00Q,23700-AA020,23700-AA160...

Repair Circuit



RH-02
 *111mm OD
 *Aluminum Heat Sink
 *M5 Battery Post w/diode Trio
 *6-35 Amp Diodes

Replaces
HITACHI : L150-13204
ISUZU : 8-94237-729-0
NISSAN : 23232-W1700

Unit No.
HITACHI : LR150-117C,LR150-133B,LR150-133E...
ISUZU : 5-81200-316-3,8-94111-836-0...
NISSAN : 23099-34W01,23099-36W01,23099-36W02...

Rectifier



RH-02C
 *111mm OD
 *Copper Heat Sinks
 *M5 Battery Post w/diode Trio
 *6-35 Amp Diodes

Replaces
HITACHI : L150-13204
ISUZU : 8-94237-729-0
NISSAN : 23232-W1700

Unit No.
HITACHI : LR150-117C,LR150-133B,LR150-133E...
ISUZU : 5-81200-316-3,5-94111-836-0...
NISSAN : 23099-34W01,23099-36W01,23099-36W02...

Diode Trio

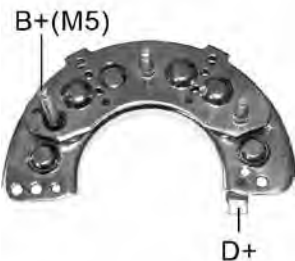

RH-03
 *111mm OD
 *Aluminum Heat Sink
 *M5 Battery Post w/diode Trio
 *6-35 Amp Diodes

Replaces
HITACHI : L150-13206,L140-93202,L150-73203,L160-6320...
ISUZU : 5-81262-006-0
NISSAN : 23230-W7101

Unit No.
HITACHI : LR150-101B,LR150-125,LR150-125B...
ISUZU : 1-81200-262-2
NISSAN : 23099-S9000,23099-T9004,23099-W5804...

Diode

Tester

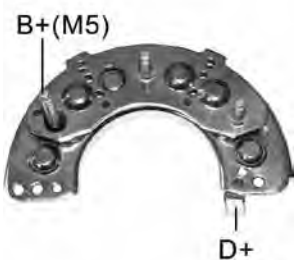

RH-03C
 *111mm OD
 *Copper Heat Sinks
 *M5 Battery Post w/diode Trio
 *6-35 Amp Diodes

Replaces
HITACHI : L150-13206
ISUZU : 5-81262-006-0
NISSAN : 23230-W7101

Unit No.
HITACHI : LR150-101B,LR150-125,LR150-125B...
ISUZU : 1-81200-262-2
NISSAN : 23099-S9000,23099-T9004,23099-W5804...



RH-04

- *111mm OD
- *Aluminum Heat Sink
- *M5 Battery Post w/diode Trio
- *6-35 Amp Diodes

Replaces

- HITACHI : L140-13202,L140-53202,L150-43203...
- ISUZU : 8-94167-411-0
- NISSAN : 23232-09W01,23232-10G01,23232-18A00...

Unit No.

- HITACHI : LR140-130P,LR140-402,LR140-408...
- ISUZU : 8-94122-488-3,8-94452-739-0
- NISSAN : 23099-09W00,23099-29W00,23099-C6808...



RH-04C

- *111mm OD
- *Copper HEat Sinks
- *M5 Battery Post w/diode Trio
- *6-35 Amp Diodes

Replaces

- HITACHI : L140-13202,L140-53202,L150-83201...
- ISUZU : 8-94167-411-0
- NISSAN : 23232-09W01,23232-10G01,23232-18A00...

Unit No.

- HITACHI : LR140-130P,LR140-402,LR140-408...
- ISUZU : 8-94122-488-3,8-94452-739-0
- NISSAN : 23099-09W00,23099-29W00,23099-C6808...



RH-04N

- *111mm OD
- *Iron Heat Sink
- *M5 Battery Post w/diode Trio
- *6-35 Amp Diodes

Replaces

- HITACHI : L140-13202,L140-53202,L150-43203...
- ISUZU : 8-94167-411-0
- NISSAN : 23232-09W01,23232-10G01,23232-18A00...

Unit No.

- HITACHI : LR140-130P,LR140-402,LR140-408...
- ISUZU : 8-94122-488-3,8-94452-739-0
- NISSAN : 23099-09W00,23099-29W00,23099-C6808...

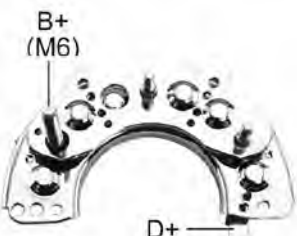

RH-08C

- *111mm OD
- *Copper Heat Sinks
- *M6 Battery Post w/diode Trio
- *6-35 Amp Diodes

Replaces

- HITACHI : L160-33202,L160-73202

Unit No.

- HITACHI : LR150-194B,LR150-197,LR150-197B...
- NISSAN : 23100-80W00



RH-09C

- *111mm OD
- *Copper HEat Sinks
- *M5 Battery Post
- *6-35 Amp Diodes

Replaces

- HITACHI : L150-13202
- NISSAN : 23230-P4505
- SUBARU : 49534-7001

Unit No.

- HITACHI : LT150-131,LT150-144

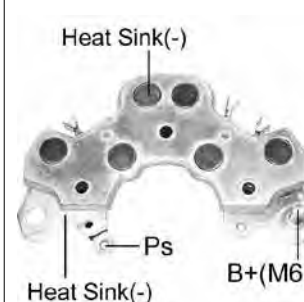

RH-102

- *119mm OD
- *12-35 Avalanche Diodes
- *M6 Battery Post

Unit No.

- HITACHI : LR1130-703,LR1130-703A,LR1130-703B...
- NISSAN : 23100-EA200,23100-EA20A,23100-EA20AR

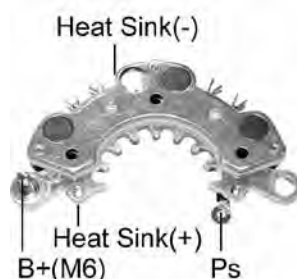

RH-103

- *114mm OD
- *M6 Battery Post
- *6-50A Avalanche Diodes

Unit No.

- HITACHI : LR180-769
- NISSAN : 23100-4Z400

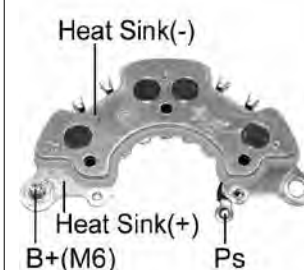

RH-104

- *119mm OD
- *M6 Battery Post
- *8-35A Avalanche Diodes

Unit No.

- HITACHI : LR1110-501
- SUZUKI : 89724-82970

Brush Holder

Voltage Regulator

Repair Circuit

Rectifier

Diode Trio

Diode

Tester

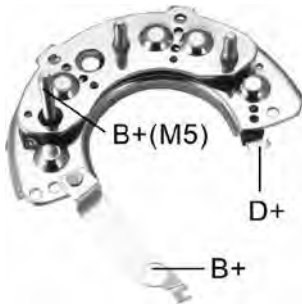

RH-10C

*111mm OD
 *Copper HEat Sinks
 *Same as RH-03C except with Strap Terminal
 *M5 Battery Post w/diode Trio
 *6-35 Amp Diodes

Replaces

HITACHI : L150-13206
 ISUZU : 5-81262-006-0
 NISSAN : 23230-W7101

Unit No.

HITACHI : LR150-101B,LR150-125,LR150-125B...
 ISUZU : 1-81200-262-2
 NISSAN : 23099-S9000,23099-T9004,23099-W5804...

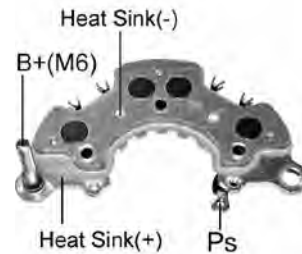

RH-111

*119mm OD
 *M6 Battery Post
 *8-50A Avalanche Diodes

Unit No.

HITACHI : LR280-501,LR280-506,LR280-508
 ISUZU : 8-97248-914-1,8-97332-502-0...

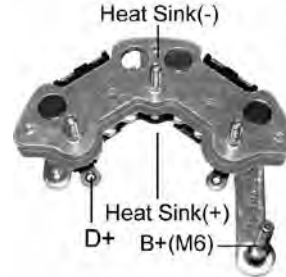

RH-113

*119mm OD
 *M6 Battery Post w/diode Trio
 *6-35A Avalanche Diodes

Unit No.

HITACHI : LR190-502B, LR190-502C
 NISSAN : 23100-05D01



RH-115

*119mm OD
 *M8 Battery Post
 *8-50A Avalanche Diodes

Unit No.

HITACHI : LR280-708B

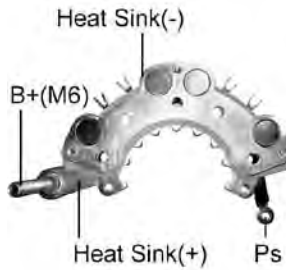

RH-116

*114mm OD
 *8-50 Amp Diodes
 *M6 Battery Post

Unit No.

HITACHI : LR250-508

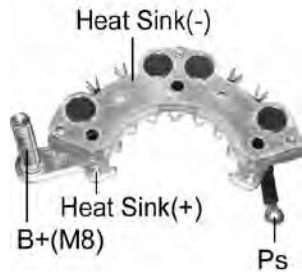

RH-117

*114mm OD
 *8-50 Amp Diodes
 *M8 Battery Post

Unit No.

HITACHI : LR250-707

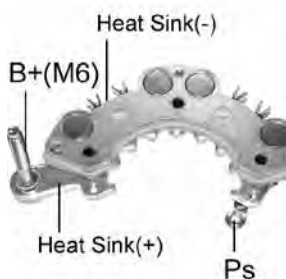

RH-119

*114mm OD
 *8-35 Avalanche Diodes
 *M6 Battery Post

Unit No.

HITACHI : LR250-517

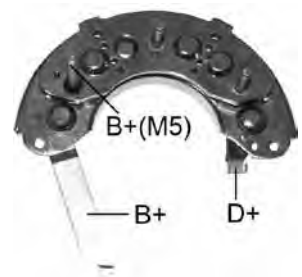

RH-11C

*118mm OD
 *Copper Heat Sinks
 *Same as RH-01C except with Strap Terminal(66mm X 2.5mm)
 *M5 Battery Post w/diode Trio
 *6-35 Amp Diodes

Replaces

HITACHI : L150-13203,L160-3320
 NISSAN : 23230-06500,23230-Q4601
 SUBARU : 49534-7101

Unit No.

HITACHI : LR155-15C,LR160-104,LR160-105,LR160-109...
 NISSAN : 23100-29R00,23100-D0201,23100-D0800...
 SUBARU : 23700-AA00Q,23700-AA020,23700-AA160...

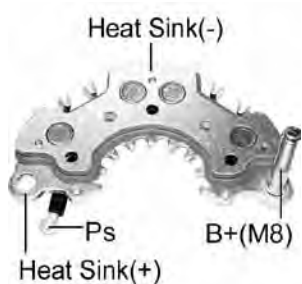

RH-120

*119mm OD
 *M8 Battery Post
 *8-35A Avalanche Diodes

Unit No.

HITACHI : LR1110-712

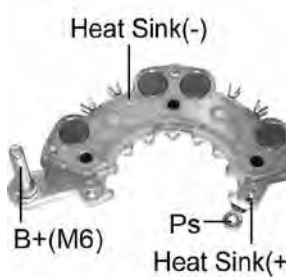





RH-121

*114mm OD
 *M6 Battery Post
 *8-35A Avalanche Diodes

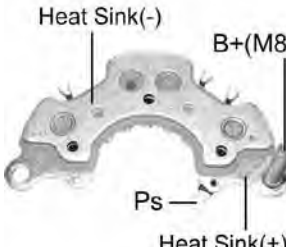
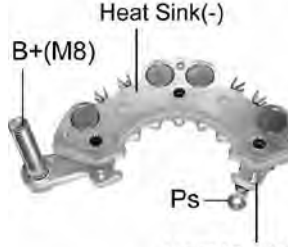
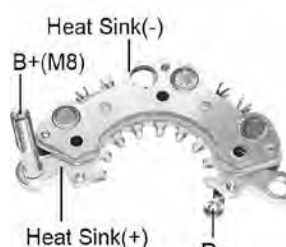
Unit No.

HITACHI : L250G-13081

 <p>RH-122 *119mm OD *M8 Battery Post w/diode Trio *6-50A Avalanche Diodes</p> <p>Unit No. HITACHI : LR1110-503</p>	 <p>RH-123 *114mm OD *M8 Battery Post *8-35A Avalanche Diodes</p> <p>Unit No. HITACHI : LR160-502E, LR160-503E,LR180-512 ISUZU : 89724-02702</p>
 <p>RH-126 *114mm OD *M8 Battery Post *6-50A Avalanche Diodes</p> <p>Unit No. HITACHI : LR180-756</p>	
 <p>RH-12C *118mm OD *Copper Heat Sinks *Same as RH-01C except with Strap Terminal.(66mm X 8.6mm) *M5 Battery Post w/diode Trio *6-35 Amp Diodes</p> <p>Replaces HITACHI : L150-13203,L160-3320 NISSAN : 23230-06500,23230-Q4601 SUBARU : 49534-7101</p> <p>Unit No. HITACHI : LR155-15C,LR160-104,LR160-105,LR160-109... NISSAN : 23100-29R00,23100-D0201,23100-D0800... SUBARU : 23700-AA00Q,23700-AA020,23700-AA160...</p>	
 <p>RH-14C *118mm OD *Copper Heat Sinks *w/diode Trio *6-35 Amp Diodes</p> <p>Replaces HITACHI : L160-23201 ISUZU : 8-94116-432-0 NISSAN : 23232-W1705</p> <p>Unit No. HITACHI : LR160-107B,LR160-108B,LR160-143B... ISUZU : 8-94155-308-5,8-94155-309-5... NISSAN : 23099-W1705,23100-11H00,23100-17S05...</p>	
 <p>RH-15 *118mm OD *Aluminum Heat Sinks *6-35 Amp Diodes *w/Diode Trios</p> <p>Replaces HITACHI : L160-23202,L160-43202 NISSAN : 23245-V7200</p> <p>Unit No. HITACHI : LR160-422B,LR170-402,LR170-404... NISSAN : 23100-54A02,23100-V7204</p>	
 <p>RH-15C *118mm OD *Copper Heat Sinks *w/diode Trio *6-35 Amp Diodes</p> <p>Replaces HITACHI : L160-23202,L160-43202 NISSAN : 23245-V7200</p> <p>Unit No. HITACHI : LR160-422B,LR170-402,LR170-404... NISSAN : 23100-54A02,23100-V7204</p>	

Brush Holder



RH-16C

- *100mm OD
- *Copper Heat Sinks
- *6-35 Amp Diodes

Replaces

- HITACHI : L140-23201
- ISUZU : 5-81218-029-0
- MAZDA : 1456-24-510

Unit No.

- HITACHI : LT135-63B,LT140-109B,LT140-109C...
- ISUZU : 5-81200-266-4,5-81200-279-2
- MAZDA : 1456-18-300A

Voltage Regulator

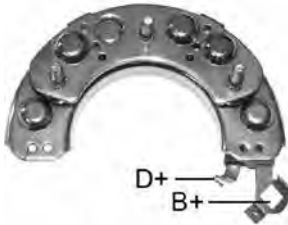

RH-17C

- *100mm OD
- *Copper Heat Sinks
- *w/diode Trio
- *6-35 Amp Diodes

Replaces

- HITACHI : L140-53201
- ISUZU : 8-94246-957-1

Unit No.

- HITACHI : LR140-131,LR140-131B



RH-18C

- *100mm OD
- *Copper Heat Sinks
- *M5 Battery Post w/diode Trio
- *6-35 Amp Diodes

Replaces

- HITACHI : L135-13208
- NISSAN : 23230-37504

Unit No.

- HITACHI : LR120-123,LR120-16B,LR135-104,LR135-116...

Repair Circuit



RH-20C

- *100mm OD
- *Copper Heat Sinks
- *M5 Battery Post w/diode Trio
- *6-35 Amp Diodes

Replaces

- HITACHI : L135-3320
- ISUZU : 8-42213-40
- YANMAR : L135-332000

Unit No.

- HITACHI : LR135-105,LR135-126,LR135-74

Rectifier

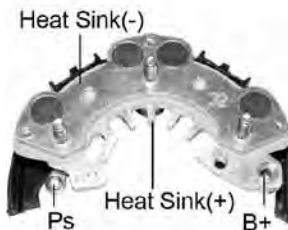

RH-21

- *103mm OD
- *8-35 Amp Diodes

Replaces

- HITACHI : L170-33202
- SUBARU : 23830-AA040

Unit No.

- HITACHI : LR170-732B,LR170-732C
- SUBARU : 23700-AA090

Diode Trio

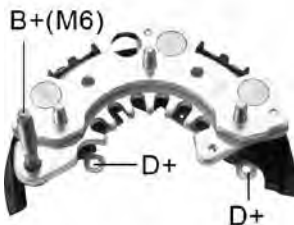

RH-22

- *103mm OD
- *M6 Battery Post w/diode Trio
- *6-35 Amp Diodes

Replaces

- HITACHI : L170-43202,L170G-3320,L170G-6320,L180G-1320
- NISSAN : 23230-12G01,23230-77P00,23230-53F00

Unit No.

- HITACHI : LR170-734,LR170-734B,LR170-739
- NISSAN : 23100-12B02,23100-88G00

Diode

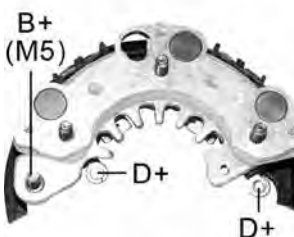

RH-23

- *103mm OD
- *M5 Battery Post w/diode Trio
- *6-35 Amp Diodes
- *w/diode trio

Replaces

- HITACHI : L180-13202
- NISSAN : 23230-64J00

Unit No.

- HITACHI : LR160-723,LR160-723B,LR180-725
- NISSAN : 23100-80G09R

Tester

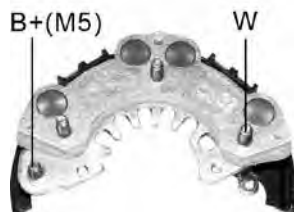

RH-24
 *103mm OD
 *M5 Battery Post
 *8-35 Amp Diodes

Replaces
 HITACHI : L170-23203
 NISSAN : 23230-50Y06
Unit No.
 HITACHI : LR170-738,LR170-738B
 NISSAN : 23100-50Y06,23100-50Y09

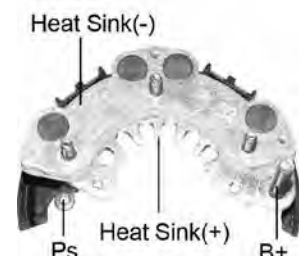

RH-25
 *103mm OD
 *M6 Battery Post
 *8-35 Amp Diodes

Replaces
 HITACHI : L170G-2320
 NISSAN : 23230-0E705
Unit No.
 HITACHI : LR170-738C
 NISSAN : 23100-0E705

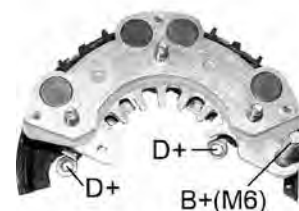

RH-26
 *103mm OD
 *M6 Battery Post w/diode Trio
 *8-35 Amp Diodes

Replaces
 HITACHI : L170G-1320
 NISSAN : 23230-50Y09
Unit No.
 HITACHI : LR160-726,LR170-738B
 NISSAN : 23100-50Y09

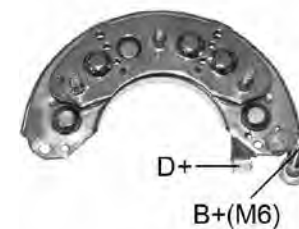

RH-27
 *118mm OD
 *Aluminum Heat Sink
 *M6 Battery Post w/diode Trio
 *6-35 Amp Diodes
Replaces
 HITACHI : L170-93202,
 L170G-73201,L170G-8320
Unit No.
 HITACHI : LR170-417,
 LR170-417C,LR170-417E...

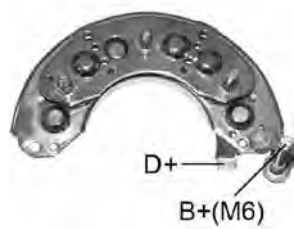

RH-27C
 *118mm OD
 *Copper Heat Sink
 *M6 Battery Post w/diode Trio
 *6-35 Amp Diodes
Replaces
 HITACHI : L170-93202,
 L170G-73201,L170G-8320
Unit No.
 HITACHI : LR170-417B,
 LR170-417C,LR170-417E...

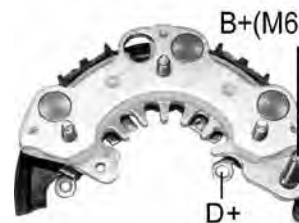

RH-28
 *103mm OD
 *M6 Battery Post
 *6-35 Amp Diodes

Unit No.
 HITACHI : LR150-711



RH-29
 *103mm OD
 *M5 Battery Post
 *6-35 Amp Diodes

Replaces
 HITACHI : L180G-7320
 NISSAN : 23230-1E400,23230-56G00
Unit No.
 HITACHI : LR170-739,LR180-725B,LR180-725C...
 NISSAN : 23100-1E400

Brush Holder

Voltage Regulator

Repair Circuit

Rectifier

Diode Trio

Diode

Tester

Brush Holder

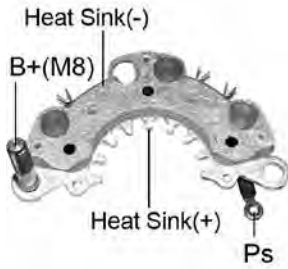

RH-30
 *114mm OD
 *M8 Battery Post
 *6-35 Amp Diodes

Unit No.
 HITACHI : LR170-745

Voltage Regulator

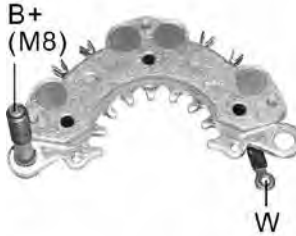

RH-31
 *114mm OD
 *M8 Battery Post
 *8-35 Amp Diodes

Unit No.
 HITACHI : LR170-748,LR170-748B,LR180-751,LR190-729

Repair Circuit

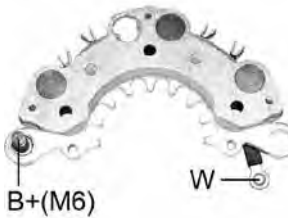

RH-32
 *114mm OD
 *M6 Battery Post
 *6-35 Amp Diodes

Unit No.
 HITACHI : LR180-741H,LR180-744
 NISSAN : 23100-1E800

Rectifier

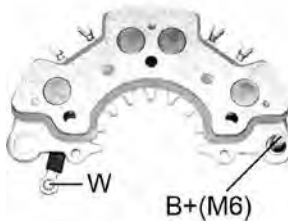

RH-33
 *114mm OD
 *M6 Battery Post
 *8-35 Amp Diodes

Replaces
 HITACHI : L190G-33204,L190G-63205
 SUBARU : 23830-AA100,23830-AA140,23830-AA180
Unit No.
 HITACHI : LR190-724
 NISSAN : 23100-70F05

Diode Trio

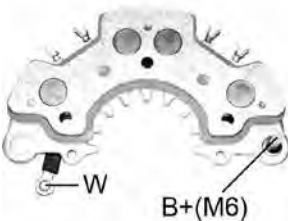

RH-35
 *119mm OD
 *M6 Battery Post
 *8-40A Avalanche Diodes

Replaces
 HITACHI : L1110G-4320,L1125G-2320
Unit No.
 HITACHI : LR1110-705,LR1125-702B
 NISSAN : 23100-31U01,23100-31U02

Diode

Tester

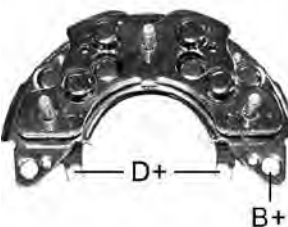

RH-39C
 *100mm OD
 *Copper Heat Sinks
 *w/diode Trio
 *6-35 Amp Diodes

Replaces
 HITACHI : L170-9320
 NISSAN : 23230-51S00
Unit No.
 HITACHI : LR150-704,LR150-715,LR170-716B
 NISSAN : 23100-51S00,23100-53A00,23100-D4405

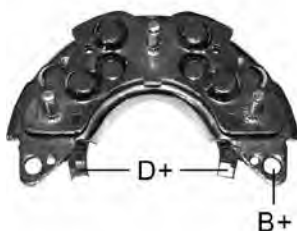

RH-40C
 *100mm OD
 *Copper Heat Sinks
 *w/diode Trio
 *8-35 Amp Diodes

Replaces
HITACHI : L165-6320,L165-7320,L170-7302
NISSAN : 23230-77A00
SUBARU : 23830-AA020

Unit No.
HITACHI : LR165-704B,LR165-707B,LR180-715
NISSAN : 23100-77A00
SUBARU : 23700-AA150

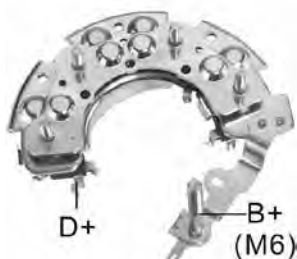

RH-43C
 *113mm OD
 *Copper Heat Sinks
 *M6 Battery Post w/diode Trio
 *8-35 Amp Diodes

Replaces
HITACHI : L190-1320,L190-3320,L190-5320
NISSAN : 23230-F6101,23230-V4360

Unit No.
HITACHI : LR190-701B,LR190-702B,LR190-702C...
NISSAN : 23100-85E00,23100-V4060,23100-V4360...

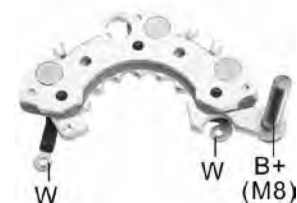

RH-48
 *115mm OD
 *M8 Battery Post
 *6-35 Amp Diodes

Replaces
HITACHI : L170G-3319

Unit No.
LUCAS : LRB303



RH-49
 *6-35 Amp Diodes

Replaces
HITACHI : L125-6320,L125-8320,L140-6320,L140-7320...
ISUZU : 5-81200-084-0,5-81200-114-0,5-81218-001-0...
LUCAS : 21511125,UBJ102
NISSAN : 23230-H0300,23230-U0100,23232-B8000...
SUBARU : 31441-00-808

Unit No.
HITACHI : LR135-30,LR135-35,LR135-73,LR150-05...
ISEKI : 6581-200-272-0
ISUZU : 5-81200-101-1,5-81200-109-0...
NISSAN : 012149277200,012475677200,18504-6071...
SUBARU : 32990-53300

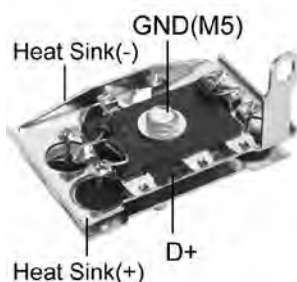

RH-50
 *6-35 Amp Diodes

Replaces
LUCAS : 21511112,UBJ105
NISSAN : 23230-E3200

Unit No.
HITACHI : LR140-130P,LR140-402,LR150-02,LR150-11...
NISSAN : 23100-P2500,23100-P2501,23100-U9500

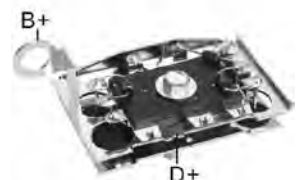

RH-51
 *6-35 Amp Diodes

Replaces
HITACHI : L135N-13201,L150N-13202
LUCAS : 21511119
MAGNETI MARELLI : 940038249
NISSAN : 23230-B9800,23230-P2501

Unit No.
HITACHI : LR135-36,LR135-44,LR135-51,LR135-53
NISSAN : 23100-B9800,23100-B9801,23100-H7700...

Brush Holder

Voltage Regulator

Repair Circuit

Rectifier

Diode Trio

Diode

Tester



RH-53C
 *100mm OD
 *Copper Heat Sinks
 *M6 Battery Post w/diode Trio
 *8-35 Amp Diodes

Replaces
 HITACHI : L170G-73202

B+ (M6) D+

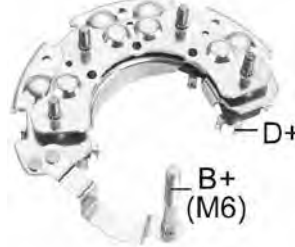

RH-58C
 *119mm OD
 *Copper Heat Sinks
 *M6 Battery Post w/diode Trio
 *6-35 Amp Diodes

Replaces
 HITACHI : L180G-8320
 ISUZU : 8-97062651-0

Unit No.
 HITACHI : LR180-501,LR180-501B

D+ B+ (M6)

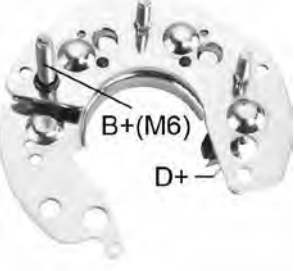

RH-59C
 *98mm OD
 *Copper Heat Sinks
 *M6 Battery Post w/diode Trio
 *6-35 Amp Diodes

Replaces
 HITACHI : L160-33201

Unit No.
 HITACHI : LR160-702B, LR160-703B

B+ (M6) D+

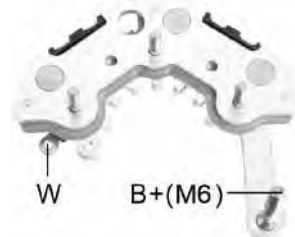

RH-60
 *118mm OD
 *M6 Battery Post
 *6-35Amp Diodes

Replaces
 HITACHI : L190G-33201

Unit No.
 HITACHI : LR170-502C, LR190-505E,LR190-511...

W B+ (M6)

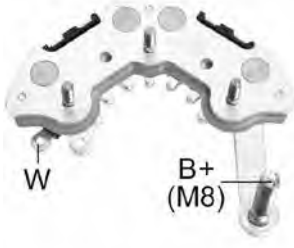

RH-61
 *118mm OD
 *M8 Battery Post
 *8-35 Amp Diodes

Replaces
 HITACHI : L1100G-5320

Unit No.
 HITACHI : LR190-512C
 NISSAN : 23100-5C310

W B+ (M8)

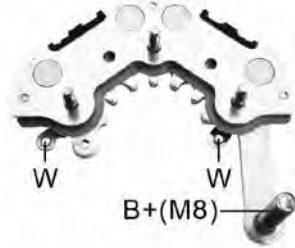

RH-63
 *118mm OD
 *w/two terminals
 *M8 Battery Post
 *8-35 Amp Diodes

Unit No.
 HITACHI : LR1100-501B

W B+ (M8)

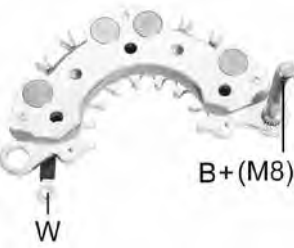

RH-65
 *114mm OD
 *M8 Battery Post
 *8-35 Amp Diodes

Replaces
 HITACHI : L160G-53201

Unit No.
 HITACHI : LR160-728B, LR160-728C,LR160-732B...

W B+ (M8)

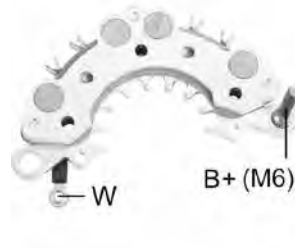

RH-66
 *114mm OD
 *M6 Battery Post
 *8-35 Amp Diodes

Unit No.
 HITACHI : LR170-755
 ISUZU : 8-97130-776-0

W B+ (M6)

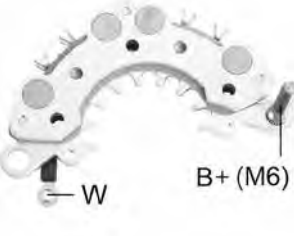

RH-66A
 *114mm OD
 *M6 Battery Post
 *8-50A Avalanche Diodes

Unit No.
 HITACHI : LR170-755

W B+ (M6)

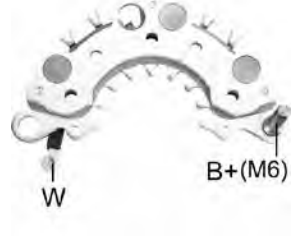

RH-67A
 *110mm OD
 *M6 Battery Post
 *6-50A Avalanche Diodes

Unit No.
 HITACHI : LR160-730C,LR160-731
 ISUZU : 8-97130-752-0

W B+ (M6)

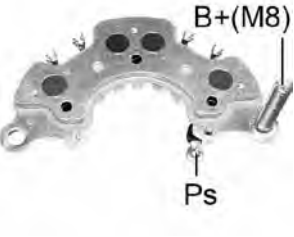

RH-68
 *120mm OD
 *M8 Battery Post w/o diode Trio
 *8-35A Avalanche Diodes
 *For Use on 70A Alternators

Unit No.
 HITACHI : LR1100-502E, LR1100-502F,LR1100-502G...



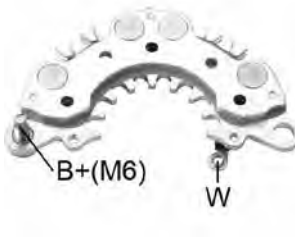



B+ (M8) Ps

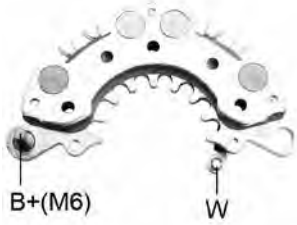
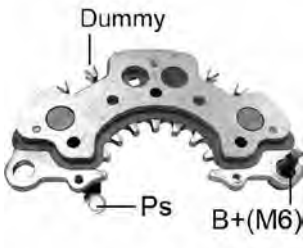
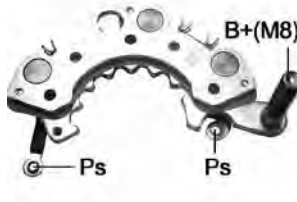

RH-69
 *114mm OD
 *M6 Battery Post
 *8-50A Avalance Diodes

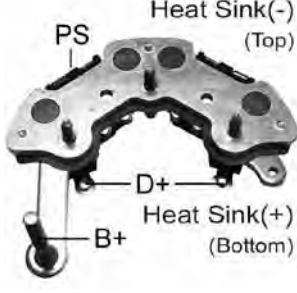
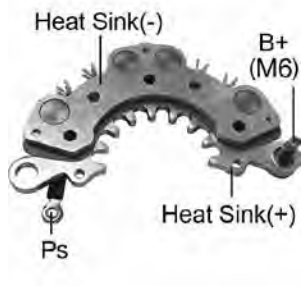
Unit No.
 HITACHI : LR1100-722, LR170-709B
 NISSAN : 23100-5M000, 23100-9E000

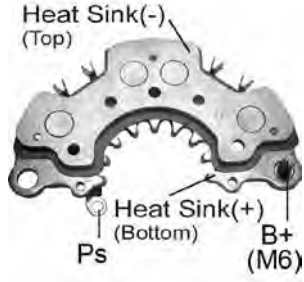
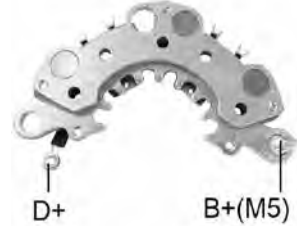
B+ (M6) W

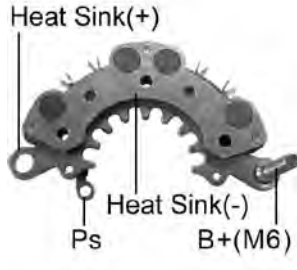
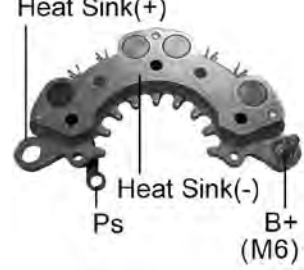
 <p>RH-70 *114mm OD *M6 Battery Post *8-35 Amp Diodes</p> <p>Unit No. HITACHI : LR170-757B NISSAN : 23100-3S500</p> <p>B+(M6) W</p>	 <p>RH-71 *120mm OD *M6 Battery Post *6-50A Avalanche Diodes</p> <p>Replaces HITACHI : L1100G-23201</p> <p>Unit No. HITACHI : LR1100-711B, LR1110-725</p> <p>Dummy Ps B+(M6)</p>	<p>Brush Holder</p>
 <p>RH-72 *115mm OD *M8 Battery Post *Same as RH-48 but w/6-50A Avalanche Diodes</p> <p>Replaces HITACHI : L170G-3319</p> <p>Unit No. HITACHI : LRB303</p> <p>B+(M8) Ps Ps</p>	 <p>RH-73 *120mm OD *M8 Battery Post w/o diode Trio *8-50A Avalanche Diodes *For Use on 100A Alternators</p> <p>Unit No. HITACHI : LR1100-503B, LR1100-507B,LR1100-503C...</p> <p>B+(M8) Ps</p>	<p>Voltage Regulator</p>
 <p>RH-74A *8-50 Amp Diodes *M6 Battery Post *w/Diode Trios</p> <p>Unit No. HITACHI : LR250-502C, LR250-507,LR250-507C ISUZU : 8-97075-883-2, 8-97148-496-0...</p> <p>PS Heat Sink(-) (Top) D+ B+ Heat Sink(+) (Bottom)</p>	 <p>RH-75 *124mm OD *M6 Battery Post *8-35A Avalanche Diodes</p> <p>Replaces HITACHI : L190G-33204 SUBARU : 23830-AA100, 23830-AA140</p> <p>Unit No. HITACHI : LR185-701, LR185-701C,LR185-702</p> <p>Heat Sink(-) B+(M6) Heat Sink(+) Ps</p>	<p>Repair Circuit</p>
 <p>RH-76 *110mm OD *M5 Battery Post w/o diode Trio *8-35 Amp Diodes</p> <p>Unit No. HITACHI : LR190-737, LR190-737E NISSAN : 23100-0W001</p> <p>B+(M5) Ps</p>	 <p>RH-77 *120mm OD *M6 Battery Post *8-50A Avalanche Diodes</p> <p>Replaces HITACHI : L1110G-23201, L1110G-6320,L1110G-73082... NISSAN : 23230-0L700</p> <p>Unit No. HITACHI : LR1100-703B, LR1100-711,LR1100-711B... NISSAN : 23100-L701</p> <p>Heat Sink(-) (Top) Heat Sink(+) (Bottom) Ps B+(M6)</p>	<p>Rectifier</p>
 <p>RH-78 *114mm OD *M5 Battery Post *6-35 Amp Diodes</p> <p>Unit No. KIA : OK012-18300,OK241-18300</p> <p>D+ B+(M5)</p>	 <p>RH-80 *M6 Battery Post *8-35A Avalanche Diodes</p> <p>Unit No. HITACHI : LR165-713</p> <p>B+(M6) Ps</p>	<p>Diode Trio</p>
 <p>RH-82 *114mm OD *M6 Battery Post *8-35 Amp Diodes</p> <p>Replaces HITACHI : 234829</p> <p>Unit No. HITACHI : LR190-744 ISUZU : 29027-68300,89720-43320</p> <p>Heat Sink(+) Heat Sink(-) Ps B+(M6)</p>	 <p>RH-83 *114mm OD *M6 Battery Post *8-50A Avalanche Diodes</p> <p>Unit No. HITACHI : LR190-742 SUBARU : 23700-AA31A</p> <p>Heat Sink(+) Heat Sink(-) Ps B+(M6)</p>	<p>Diode</p>
<p>For more reference information please see Cross Reference List at the front of the catalogue All maker's names & nummers are used for reference purposes only.</p>		<p>Tester</p>

Brush Holder

Voltage Regulator

Repair Circuit

Rectifier

Diode Trio

Diode

Tester

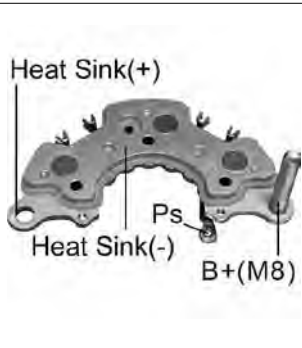

RH-85
 *120mm OD
 *M8 Battery Post w/o diode Trio
 *6-50A Avalanche Diodes

Unit No.
HITACHI : LR1100-502MD

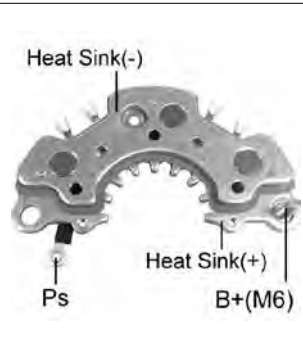

RH-91
 *120mm OD
 *M6 Battery Post
 *6-35A Avalanche Diodes

Unit No.
HITACHI : LR1110-713V,
 LR1110-713C
NISSAN : 23100-AU400,
 23100-AU40D,23100-JA02C

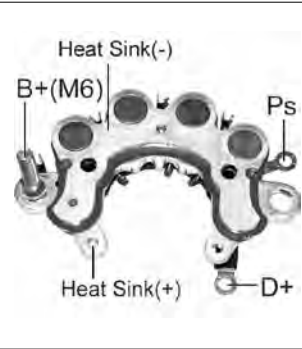

RH-92
 *95mm OD
 *M6 Battery Post w/diode trio
 *8-50 Amp Diodes

Unit No.
HITACHI : LR160-735B,LR160-735
YANMAR : 123900-77210

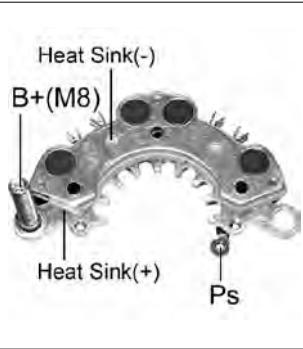

RH-93
 *114mm OD
 *M8 Battery Post
 *8-35 Avalanche Diodes

Unit No.
HITACHI : LR1100-715



RH-94
 *119mm OD
 *M6 Battery Post w/ diode Trio
 *6-50 Amp Diodes

Unit No.
NISSAN : 23100-0T002

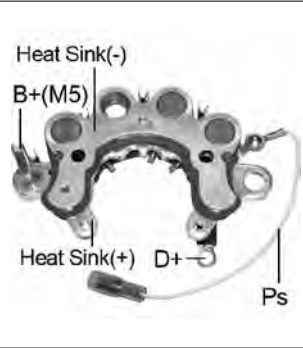

RH-95
 *95mm OD
 *M5 Battery Post
 *6-35 Amp Diodes

Unit No.
HITACHI : LR140-721,
 LR140-721B,LR140-721C
YANMAR : 129612-77230

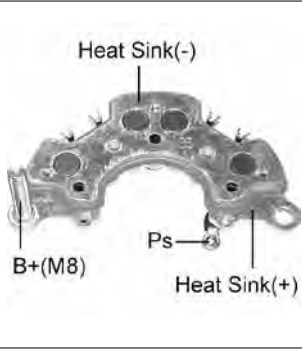

RH-97
 *119mm OD
 *M8 Battery Post w/diode Trio
 *8-35A Avalanche Diodes

Unit No.
HITACHI : LR1110-504



RV-H001
 *Complete set with VR-H2000-53 + RH-72

Unit No.
HITACHI : LR170-505



RV-H002
 *Complete set with VR-H2000-50 + RH-73

Unit No.
HITACHI : LR1100-502E,
 LR1100502,LR1100502B...
ISUZU : 897181891130,
 8971891133,8971891134...
VAUXHALL : 1204158,6240140,
 9312785,93175799...



RV-H003B
 *24V
 *Complete set with VR-H2000-86B + RH-74

Unit No.
HITACHI : LR250-502C,
 LR250-507,LR250-507C
ISUZU : 8-97075-883-2,
 8-97148-496-0...















RV-H004
 *Complete set with VR-H2000-57 + RH-80

Unit No.
HITACHI : LR165-713



RV-H005A
 * Complete set with VR-H2000-29A-2+ RH-04N
 * Voltage regulator with capacitor

Unit No.
HITACHI : LR150-431

 <p>RV-H005BA * 24V * Complete set with VR-H2000-29BA-2 + RH-04N * Voltage regulator with capacitor</p> <p>Unit No. HITACHI : LR270-05</p>	 <p>RV-H008 *Complete set with VR-H2000-64 + RH-85</p> <p>Unit No. HITACHI : LR1100-502MD</p>	<p>Brush Holder</p>
 <p>RV-H009 *Complete set with VR-H2000-24 + RH-28</p> <p>Unit No. HITACHI : LR150-711</p>	 <p>RV-H013 *Complete set with VR-H2000-65 + RH-58C</p> <p>Unit No. HITACHI : LR180-502R</p>	<p>Voltage Regulator</p>
 <p>RV-H017B *24V *Complete set with VR-H2000-70B + RH-111</p> <p>Unit No. HITACHI : LR280-501, LR280-506,LR280-508 ISUZU : 8-97351-574-0, 8-97248-914-1...</p>	 <p>RV-H022 *Complete set with VR-H2000-72 + RH-92</p> <p>Unit No. HITACHI : LR160-735, LR160-735B YANMAR : 123900-77210</p>	<p>Repair Circuit</p>
 <p>RV-H023 *Complete set with VR-H2000-74 + RH-93</p> <p>Unit No. HITACHI : LR1100-715</p>	 <p>RV-H024B *24V *Complete set with VR-H2000-75B + RH-94</p> <p>Unit No. NISSAN : 23100-0T002</p>	<p>Rectifier</p>
 <p>RV-H025 *Complete set with VR-H2000-89 + RH-102</p> <p>Unit No. HITACHI : LR1130-703, LR1130-703A,LR1130-703B NISSAN : 23100-EA200, 23100-EA20A</p>	 <p>RV-H030 *Complete set with VR-H2000-64+RH-73</p> <p>Unit No. HITACHI : LR1100-508 ISUZU : 89736-95070</p>	<p>Diode Trio</p>
 <p>RV-H034 *Complete set with VR-H2000-44 + RH-69</p> <p>Unit No. HITACHI : LR1100-722 NISSAN : 23100-5M000</p>	 <p>RV-H036 *Complete set with VR-H2000-27+RH-65</p> <p>Unit No. HITACHI : LR160-728,LR160-728C NISSAN : 23100-7T402</p>	<p>Diode</p>
		<p>Tester</p>

Brush Holder

Voltage Regulator

Repair Circuit

Rectifier

Diode Trio

Diode

Tester



RV-H040
 *Complete set with VR-H2000-28 + RH-35
Replaces
 HITACHI : L1100G-3340, L1100G-9340
 NISSAN : 23215-31U05
Unit No.
 HITACHI : LR1110-705
 NISSAN : 23100-31U01, 23100-31U02



RV-H046
 *Complete set with VR-H2000-42 + RH-32
Unit No.
 HITACHI : LR160-727,LR180-744



RV-H047
 *Complete set with VR-H2000-84 + RH-91
Unit No.
 HITACHI : LR1110-713V
 NISSAN : 23100-AU400



RV-H049B
 *24V
 *Complete set with VR-H2000-70B + RH-115
Unit No.
 HITACHI : LR280-708B



RV-H050
 *Complete set with VR-H2000-44 + RH-70
Unit No.
 HITACHI : LR170-757B, LR170-757BR,LR170-765
 NISSAN : 23100-3S500, 23100-3S500R,23100-3S501



RV-H052B
 *24V
 *Complete set with VR-H2000-80B + RH-116 (M6 B+)
Unit No.
 HITACHI : LR250-508



RV-H053B
 *24V
 *Complete set with VR-H2000-80B + RH-117 (M8 B+)
Replaces
 HITACHI : L250-83081
Unit No.
 HITACHI : LR250-707C



RV-H055N
 *Complete set with VR-H2000-30+ RH-15N
Unit No.
 HITACHI : LR170-406B, LR160-422B



RV-H057B
 *24V
 *Complete set with VR-H2000-92B + RH-119
Unit No.
 HITACHI : LR250-517





RV-H077B
 *24V
 *Complete set with VR-H2000-76B + RH-121
Unit No.
 HITACHI : L250G-13081



RV-H078
 *Complete set with VR-H2000-71 + RH-123
Unit No.
 HITACHI : LR160-503E, LR160-502E,LR180-512
 ISUZU : 89724-02702

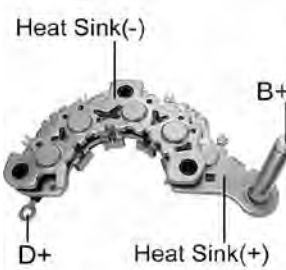
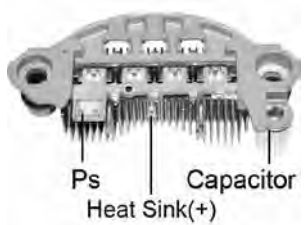
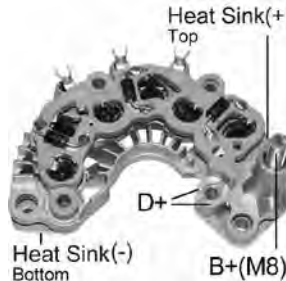
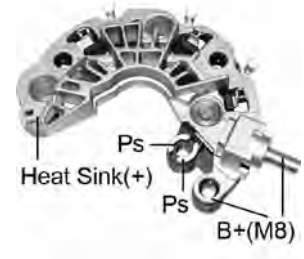

RV-H083B
 *24V
 *Complete set with VR-H2000-94B + RH-116
Unit No.
 HITACHI : LR250-511

 <p>Heat Sink(-) D+ Heat Sink(+) B+</p> <p>RK-04 *117mm OD *8-50A Avalanche Diodes *M8 Battery Post</p> <p>Replaces POONG SUNG : RES14703</p> <p>Unit No. HYUNDAI : 37300-27011, 37300-27013,37300-27010... POONG SUNG : 02131- 9111,02131-9113,02131-9110...</p>	 <p>Ps Heat Sink(+) Capacitor</p> <p>RM-191H *100mm Mtg. Length *8-30 Amp Diodes</p>
 <p>Heat Sink(+) Top D+ Heat Sink(-) Bottom B+(M8)</p> <p>RM-197 *115mm OD *M8 Battery Post *6-50A Avalanche Diodes</p> <p>Unit No. HYUNDAI : 37300-23720</p>	 <p>Ps Heat Sink(+) Ps B+(M8)</p> <p>RP-56 *103mm OD *M8 Battery Post *3-50A Avalanche Diodes *Positive rectifier</p> <p>Unit No. HYUNDAI : 37300-2B300, 37300-2E200 VALEO : 37300-2B500</p>
 <p>RV-K002 *Complete set with VR-K05+ RK-04</p> <p>Unit No. HYUNDAI : 37300-27013, 37300-27010,37300-27012... POONG SUNG : 02131-9110, 02131-9112</p>	

Brush Holder

Voltage Regulator

Repair Circuit

Rectifier

Diode Trio

Diode

Tester

Brush Holder

Voltage Regulator

Repair Circuit

Rectifier

Diode Trio

Diode

Tester



RK-01
 *M6 Battery Post
 *8-50A Avalanche Diodes
 *w/diode trio

Replaces
 ISKRA : 16903507

Unit No.
 ISKRA : 11201597,11201666,
 11201667,11201675...

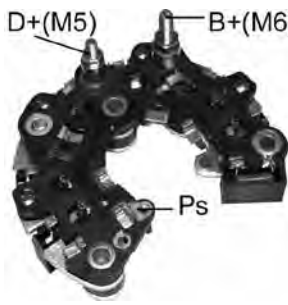

RK-02
 *M6 Battery Post
 *8-50A Avalanche Diodes
 *w/ diode trio





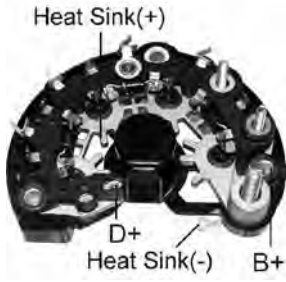



Replaces
 ISKRA : 16903314

Unit No.
 ISKRA : 11201440,11201490



RK-06
 *8-50A Avalanche Diodes

Unit No.
 LETRIKA (ISKRA) : AAN8167,
 AAN5806
 PERKINS : 2871A903

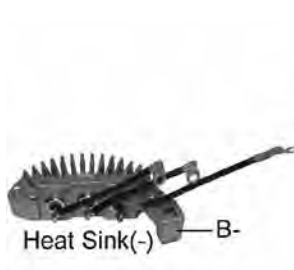
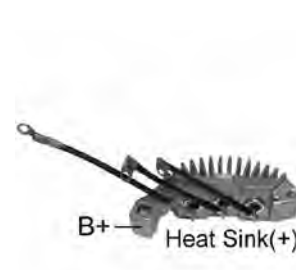
 <p>Heat Sink(+)</p> <p>RC-01HV *6-50 Amp Diodes *Positive *4884J *4806J *4900J</p> <p>Replaces LEECE NEVILLE : 101387, A051101387</p>	 <p>Heat Sink(+)</p> <p>RC-02HV *6-50 Amp Diodes *Positive *4884J *4860J *4900J</p> <p>Replaces LEECE NEVILLE : 101441, A051101441,101411</p> <p>Unit No. LEECE NEVILLE : 4830LC,4830 LCRM,4836AAH,4860J,4860JB...</p>
 <p>Heat Sink(+)</p> <p>RC-03H *6-35 Amp Diodes *Positive *JA Series Alternators *JB Series Alternators</p> <p>Replaces LEECE NEVILLE : 71180</p>	 <p>Heat Sink(-)</p> <p>RC-04H *6-35 Amp Diodes *Negative *JA Series Alternators *JB Series Alternators</p> <p>Replaces LEECE NEVILLE : 71181</p>
 <p>Heat Sink(+)</p> <p>RC-05HV *6-50 Amp Diodes *Positive *J, JB Series Alternators</p> <p>Replaces LEECE NEVILLE : 79193</p>	 <p>Heat Sink(-)</p> <p>RC-06HV *6-50 Amp Diodes *Negative *J, JB Series Alternators</p> <p>Replaces LEECE NEVILLE : 79415</p>
 <p>Heat Sink(+)</p> <p>RC-07HV *6-50 Amp Diodes *Positive *2800JB *7804-7808 J Series Alternators</p> <p>Replaces LEECE NEVILLE : 97084</p>	 <p>Heat Sink(-)</p> <p>RC-08HV *6-50 Amp Diodes *Negative *2800JB *7804-7808 J Series Alternators</p> <p>Replaces LEECE NEVILLE : 97085</p>
 <p>Heat Sink(-) — B-</p> <p>RC-17HD *6-70 Amp Diodes *Negative *4800 Series Alternator</p> <p>Unit No. LEECE NEVILLE : A0014834LC</p>	 <p>B+ — Heat Sink(+)</p> <p>RC-18HD *6-70 Amp Diodes *Positive *4800 Series Alternator</p> <p>Unit No. BLEECE NEVILLE : A0014834LC</p>

Brush Holder
 Voltage Regulator
 Repair Circuit
 Rectifier
 Diode Trio
 Diode
 Tester

Brush Holder



RL-01H
 *115mm OD
 *M6 Battery Post
 *6-35 Amp Diodes

Replaces
 CASE : K262267
 FORD : E7NN-10304AA
 LUCAS : 84201,84422,84454,84455,84499,UBB133,UBB135...
 MAGNETI MARELLI : 84454
 MASSEY FERGUSON : 1897700M91,3474648M91,3477529M91
 PERKINS : 28710253
 ROVER : BAU4920,BAU5266,BAU5813,RTC5045
 RVI : 5430021884
Unit No.
 LUCAS : 24145,24156,24157,24158,24161,24169...

Voltage Regulator

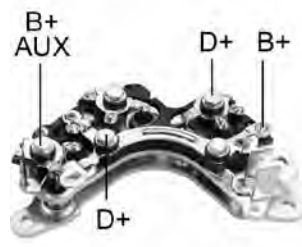

RL-02H
 *115mm OD
 *6-35 Amp Diodes

Replaces
 CASE : 245537C1
 FIAT : 9937250
 FORD : 81AB-10304AA,81DB-10304BA,82BB-10304AA...
 LUCAS : 83563,83642,83643,84719,84758,84759,UBB115...
 MASSEY FERGUSON : 1897267M1
 PERKINS : 28710225,28710236
 ROVER : BAU1825L
 RVI : 5430020198,5430020791
Unit No.
 LLUCAS : 23983,23984,23985,23986,24023,24024...

Repair Circuit

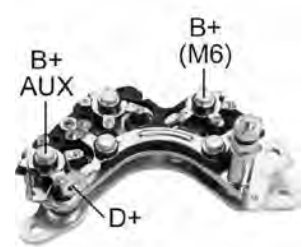

RL-03H
 *115mm OD
 *M6 Battery Post
 *6-35 Amp Diodes

Replaces
 LUCAS : 83565,83670,83757,83784,84760,84761,UBB117...
Unit No.
 LUCAS : 24041,24060,24167,24168,24171,60921062

Rectifier



RL-04H
 *115mm OD
 *6-35 Amp Diodes

Replaces
 FORD : 81AB-10304BA,81AB-10304CA
 LUCAS : 83567,83623,83645,84720,84767,UBB116,UBB121...
 MASSEY FERGUSON : 1895344M1,1897344M1
 PERKINS : 28710243
 ROVER : BAU1996,BAU2191,RTC3213
Unit No.
 LUCAS : 23996,23997,23998,23999,24020,24025...

Diode Trio

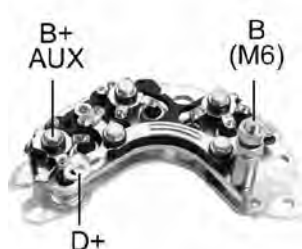

RL-05H
 *115mm OD
 *6-35 Amp Diodes

Replaces
 LUCAS : 83569,83571,84765,UBB118,UBB126
 MASSEY FERGUSON : 3475823M1
 ROVER : AEU1527,AEU1527J
Unit No.
 LUCAS : 23969,24010,24011,24046,24047,24055...

Diode

Tester

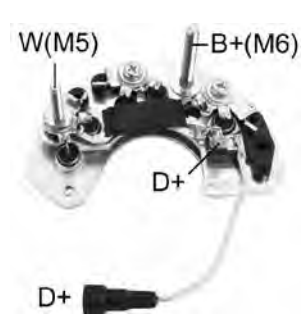

RL-06H
 *115mm OD
 *M6 Battery Post
 *6-35 Amp Diodes

Replaces
 FORD : 864F-10304AA
 LUCAS : 84456,84456010,84486,UBB140
Unit No.
 LUCAS : 24188,24213,24230,24264

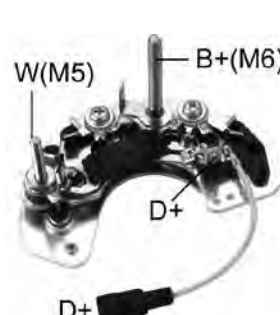

RL-07H
 *115mm OD
 *M6 Battery Post
 *6-35 Amp Diodes

Replaces
 LUCAS : 84888,UBB147
Unit No.
 LUCAS : 24255,24287

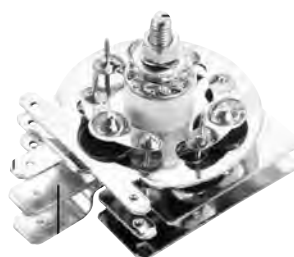

RL-08HV
*115mm OD
*9-35 Amp Diodes

Replaces
BL/JAGUAR : 37H6913,607688,90607688,JS486,UKC1662
FORD : 69EB-10304AA,D4NN-10304A
LUCAS : 83166(4DS5),83334(4DS8),83520,83842(4DS7)...
MASSEY FERGUSON : 1429443M1,1888323M1,1897094M1...
TALBOT : 75061613
Unit No.
LUCAS : 23589,23590,23591,23592,23593,23605...

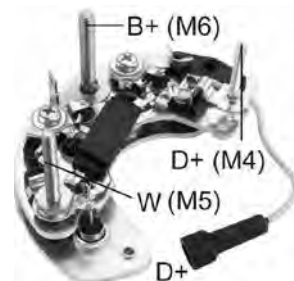

RL-09H
*115mm OD
*6-35 Amp Diodes

Replaces
FORD : 86AB-10304BA
LUCAS : 84469,UBB137,80367,80150,84886,84469010...
MAGNETI MARELLI : 000000028502,000000084469...
ROVER : LBU5225,RTC5371,RTC5671
Unit No.
LUCAS : 24206AB,24207,24207A,24216,24217,24217A...



RL-10H
*115mm OD
*M6 Battery Post
*6-35 Amp Diodes

Replaces
LUCAS : 84976,28500010,28506010
MAGNETI MARELLI : 63328506,28500,28506
Unit No.
LUCAS : 24286
NISSAN : 23100-71J00



RL-11H
*115mm OD
*M6 Battery Post
*6-35 Amp Diodes

Replaces
LUCAS : 84468,UBB136
Unit No.
LUCAS : 24203,24214

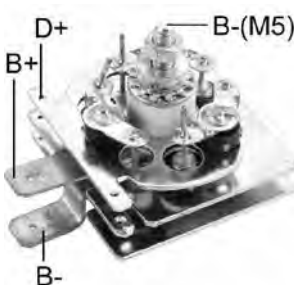

RL-12H
*9-35 Amp Diodes

Replaces
BL/JAGUAR : 37H6924,606829
FORD : 692F-10304AA
LUCAS : 83062,83178,83192,84125,84460,UBB108,83962
TALBOT : 5059884
VAUXHALL : 2698242
Unit No.
LUCAS : 23544,23548,23554,23555,23562,23563...

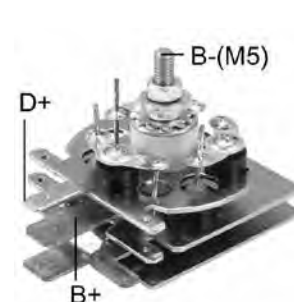

RL-13
*9-25 Amp Diodes

Replaces
BL/JAGUAR : 37H7965, RTC1004,UKC1657
LUCAS : 83295,84124,84459, UBB111
Unit No.
LUCAS : 23745,23747,23748, 23750,23793,23795...

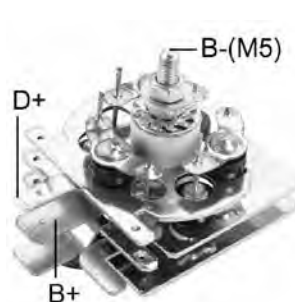

RL-13H
*M5 Battery Post
*9-35 Amp Diodes

Replaces
BL/JAGUAR : 37H7965, RTC1004,UKC1657
LUCAS : 83295,84124,84459, UBB111
Unit No.
LUCAS : 23745,23747,23748, 23750,23793,23795...

Brush Holder

Voltage Regulator

Repair Circuit

Rectifier

Diode Trio

Diode

Tester



RL-14
*9-25 Amp Diodes

Replaces
LUCAS : 83442,83633,84718, UBB113

Unit No.
LUCAS : 23835,23838,23859, 23864,23868,23869...



RL-14H
*9-35 Amp Diodes

Replaces
LUCAS : 83442,83633,84718, UBB113

Unit No.
LUCAS : 23835,23838,23859, 23864,23868,23869...

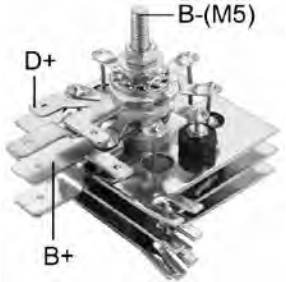

RL-15
*9-25 Amp Diodes

Replaces
BL/JAGUAR : AAU8483,BAU1830
FORD : 75AB-10304AA
LUCAS : 83452,83634,84717,UBB130
MASSEY FERGUSON : 1895097M1
TALBOT : 35140800
VAUXHALL : 91062513,91103214

Unit No.
LUCAS : 23833,23861,23862,23863,23867,23882...

Replaces
BL/JAGUAR : AAU8483,BAU1830
FORD : 75AB-10304AA
LUCAS : 83452,83634,84717,UBB130
MASSEY FERGUSON : 1895097M1
TALBOT : 35140800
VAUXHALL : 91062513,91103214

Unit No.
LUCAS : 23833,23861,23862,23863,23867,23882...

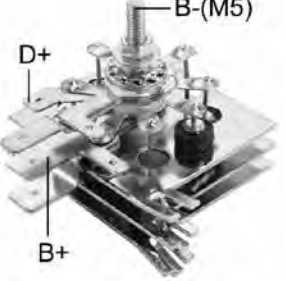

RL-15H
*M5 Battery Post
*9-35 Amp Diodes

Replaces
BL/JAGUAR : AAU8483,BAU1830
FORD : 75AB-10304AA
LUCAS : 83452,83634,84717,UBB130
MASSEY FERGUSON : 1895097M1
TALBOT : 35140800
VAUXHALL : 91062513,91103214

Unit No.
LUCAS : 23833,23861,23862,23863,23867,23882...

Replaces
BL/JAGUAR : AAU8483,BAU1830
FORD : 75AB-10304AA
LUCAS : 83452,83634,84717,UBB130
MASSEY FERGUSON : 1895097M1
TALBOT : 35140800
VAUXHALL : 91062513,91103214

Unit No.
LUCAS : 23833,23861,23862,23863,23867,23882...

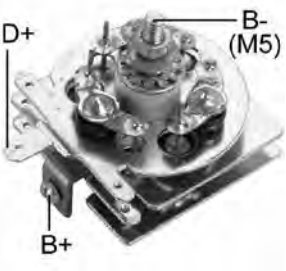

RL-16
*M5 Battery Post
*6-25 Amp Diodes

Replaces
FIAT : 9935804
LUCAS : 83584,84602,UBB128

Unit No.
FIAT : 4423302
LUCAS : 23980



RL-17H
*122 mm OD
*M6 Battery Post
*6-35 Amp Diodes

Replaces
LUCAS : 83763,UBB131
VALEO(DUCELLIER) : 593062

Unit No.
LUCAS : 23970,23970AB,23971, 23971A,24056...



RL-20H
*9-35 Amp Diodes

Replaces
LUCAS : 60211170,83320,UBB112
MAGNETI MARELLI : 940038261

Unit No.
LUCAS : 23746,23746A,23756A D,23806,23806AB...

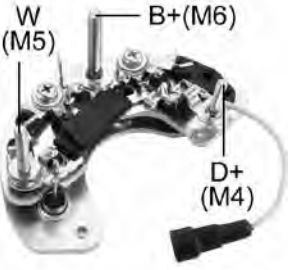

RL-21H
*115mm OD
*M6 Battery Post
*6-35 Amp Diode

Replaces
FORD : 87BB-10304CA
LUCAS : 84572,UBB145,84572010

Unit No.
LUCAS : 24215,24215A, 24216A,24224,24236,24257...



RL-22H
*115mm OD *M5 Battery Post
*6-35 Amp Diodes

Replaces
LUCAS : 84574,UBB138
NISSAN : 23230-Q9000
ROVER : BAU5816
VALEO : A559893A

Unit No.
LUCAS : 24223A,24235,24235AD ,24322A,24356A...

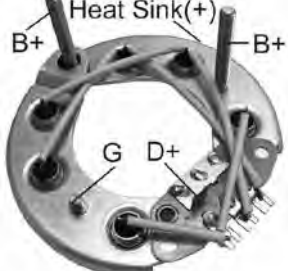

RL-23H
*6-35 Amp Diodes
*M6 Battery Post

Replaces
LUCAS : 35213274

Unit No.
LUCAS : 35213725,35213730

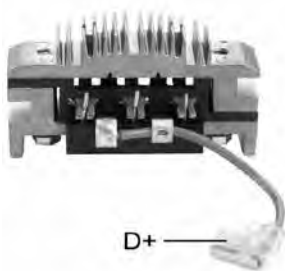
**RI-01HA**

*W/DIODE TRIO
*6-35 Amp Diodes

Replaces

FIAT : 9934595,9934958,9947325
MAGNETI MARELLI : 64826011,64826022,64826040...

Unit No.

FIAT : 4379899,4393206,4395131,4419793,4715786...
MAGNETI MARELLI : 63300515,63300905,63300925,63305000...

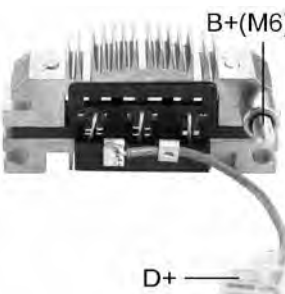
**RI-02HA**

*W/DIODE TRIO
*6-35 Amp Diodes

Replaces

DELCO REMY (LUCAS) : 21222124
FIAT : 9947325
MAGNETI MARELLI : 63621501,63621601,RDD15,RDD16

Unit No.

FIAT : 4808510,4808513,4808517,4808518,5999868...
MAGNETI MARELLI : 63320001,63320002,63320003,63320004...

**RI-04H**

*6-35 Amp Diodes
*110mm OD

Replaces

FEMSA : 19326-1
FIAT : 4149607,4149609,4175054
MAGNETI MARELLI : 74953001,74990331,74990341,74999091

Unit No.

BOSCH : 9-120-330-268,9-120-330-286
FEMSA : A124N,A12M
FIAT : 4181511,4378710,4380114,4408631,4474524...
MAGNETI MARELLI : 63301000,63301020,63303000,63303001...

**RI-05H**

*6-35 Amp Diodes
*110mm OD

Replaces

BOSCH : 9-121-337-319
FEMSA : 25945-1
FIAT : 4474546
LUCAS : 21223056,21223062,UBB601
MAGNETI MARELLI : 74965501,74966611,74966621
TOSHIBA : 6M3

Unit No.

BOSCH : 9-120-330-288,9-120-330-289
FEMSA : ALB40N88,ALB40N89
MAGNETI MARELLI : 63303200,63303202,63303203,63303213...

**RI-06H**

*6-35 Amp Diodes
*110mm OD

Replaces

BOSCH : 9-121-337-321,9-121-337-325,9-121-337-330...
FEMSA : 25945-10,25945-17,25945-20,25945-21,25945-25...
LUCAS : UBB602
MAGNETI MARELLI : 940038237
PEUGEOT : 5722.98

Unit No.

BOSCH : 9-120-331-853,9-120-331-854...
FEMSA : ALP12NR19,ALS12N53,ALS12N54,ALS12N63...

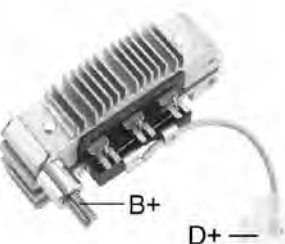
**RI-11H**

*6-35 Amp Diodes
*M6 Battery Post

Replaces

MAGNETI MARELLI : 63622001

Unit No.

MAGNETI MARELLI : 63320042,63320046,63321083,63321084...

Brush Holder

Voltage Regulator

Repair Circuit

Rectifier

Diode Trio

Diode

Tester

Brush Holder

Voltage Regulator

Repair Circuit

Rectifier

Diode Trio

Diode

Tester



RI-12H
 *6-35 Amp Diodes
 *M6 Battery Post

Replaces
 MAGNETI MARELLI : 63022101, RDD346455

Unit No.
 MAGNETI MARELLI : 63322101, 63620039



RI-13H
 *6-35 Amp Diodes

Replaces
 MAGNETI MARELLI : 63622201, RDD22

Unit No.
 MAGNETI MARELLI : 63320041, 63321083



RI-14H
 *M8 Battery Post
 *6-50A avalanche Diodes

Replaces
 MAGNETI MARELLI : 63633801, RDD33

Unit No.
 MAGNETI MARELLI : 63321204, 63321233,63321234,63321252...



RI-15H
 *M8 Battery Post
 *6-35 Amp Diodes

Replaces
 MAGNETI MARELLI : 5402243B

Unit No.
 MAGNETI MARELLI : 63320228, 63320289,63320315,63321240...



RI-16H
 *M6 Battery Post
 *6-35 Amp Diodes

Replaces
 MAGNETI MARELLI : 00084574, 54209741

Unit No.
 MAGNETI MARELLI : 54022437, 54022459,54022469,54022470...



RI-17H
 *M8 Battery Post
 *6-50A Avalanche Diodes

Replaces
 MAGNETI MARELLI : 63623601

Unit No.
 MAGNETI MARELLI : 63321353, 63321354,63341353,63341354



RI-18H
 *M6 Battery Post
 *6-50A Avalanche Diodes

Replaces
 MAGNETI MARELLI : 63623602

Unit No.
 MAGNETI MARELLI : 63320281, 63320287,63320288,63320289...

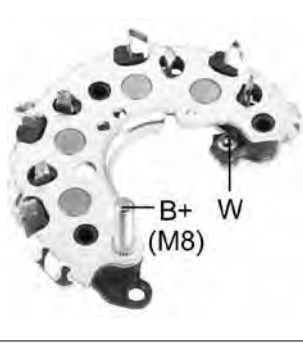

RI-19H
 *M8 Battery Post
 *8-50A Avalanche Diodes

Replaces
 MAGNETI MARELLI : 63623701

Unit No.
 MAGNETI MARELLI : 63321240



RI-21H
 *M8 Battery Post
 *6-50A Avalanche Diodes

Replaces
 MAGNETI MARELLI : 63623501, 63624701,63624801,RDD35...

Unit No.
 MAGNETI MARELLI : 63320204, 63320227,63320238,63320253...



RI-22H
 *M8 Battery Post
 *8-50A Avalanche Diodes

Replaces
 MAGNETI MARELLI : 63623801

Unit No.
 MAGNETI MARELLI : 63320255, 63320266,63320507,63320509...



RI-23H
 *M8 Battery Post
 *6-50A Avalanche Diodes

Replaces
 MAGNETI MARELLI : 63624201



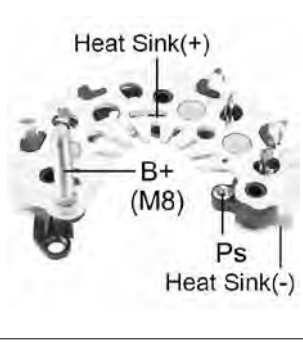

Unit No.
 MAGNETI MARELLI : 63320256, 63320277,63320279,63320280...

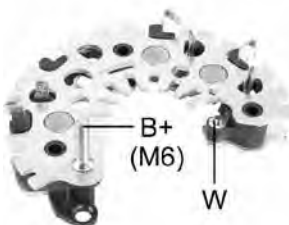
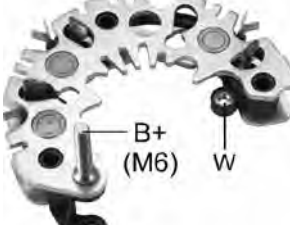

RI-23HD
 *M8 Battery Post
 *6-70A Avalanche Diodes
 *Same as RI-23H but w/ 70 Amp diodes

Replaces
 MAGNETI MARELLI : 63624201

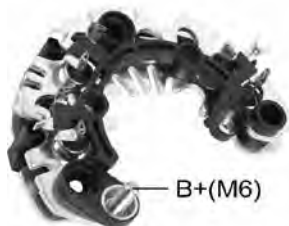
Unit No.
 MAGNETI MARELLI : 63320256, 63320277,63320279,63320280...

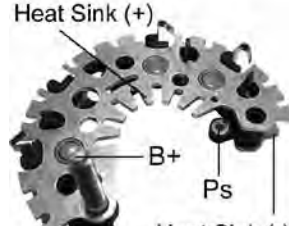
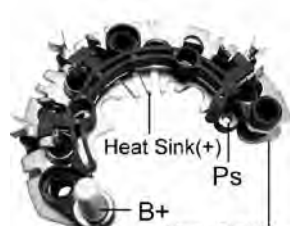
 <p>RI-24H *M6 Battery Post *6-50A Avalanche Diodes</p> <p>Replaces MAGNETI MARELLI : 63624202</p> <p>Unit No. MAGNETI MARELLI : 63320334, 63320335,63320336</p>	 <p>RI-25 *M6 Battery Post *6-50A Avalanche Diodes</p> <p>Replaces MAGNETI MARELLI : 63624802, RDD75</p> <p>Unit No. MAGNETI MARELLI : 63341238, 63341239,63341666 VALEO(PARIS RHONE) : A115I</p>
 <p>RI-26H *8-50A Avalanche Diodes</p> <p>Replaces MAGNETI MARELLI : 63321239</p>	 <p>RI-31H *107mm OD *M6 Battery Post *8-50A Avalanche Diodes</p> <p>Replaces MAGNETI MARELLI : 63624103, 233534</p> <p>Unit No. MAGNETI MARELLI : A115I, 63321348,63321356,63321692...</p>
 <p>RI-32H *M6 Battery Post *6-50A Avalanche Diodes</p> <p>Unit No. FORD : 98AB-10300GC, 98AB-10300GD,98AB-10300GE... MAGNETI MARELLI : 63321679, 63321697,63341679,63341697</p>	 <p>RI-32M *M6 Battery Post *Same as RI-32H but with Low Loss Diodes</p> <p>Unit No. FORD : 98AB-10300GC, 98AB-10300GD,98AB-10300GE... MAGNETI MARELLI : 63321679, 63321697,63341679,63341697</p>
 <p>RI-34 *6-50A Avalanche Diodes</p> <p>Unit No. DENSO : 102211-8641, 102211-8650,102211-8661</p>	 <p>RI-35 *M8 Battery Post *6-50A Avalanche Diodes</p> <p>Replaces MAGNETI MARELLI : 63625002, 85552103,85552104...</p> <p>Unit No. DENSO : 102211-8622 MAGNETI MARELLI : 63320500, 63320502,63320510,63321287... OPEL : 13256929</p>

- Brush Holder
- Voltage Regulator
- Repair Circuit
- Rectifier
- Diode Trio
- Diode
- Tester

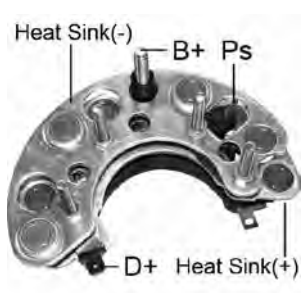

RK-03
 *8-50A Avalanche Diodes
 *w/diode trio

Replaces
MAGNETON-PAL : 0135940,
 0135941,0140880,0140881...

Brush Holder

Voltage Regulator



Repair Circuit

Rectifier

Diode Trio

Diode

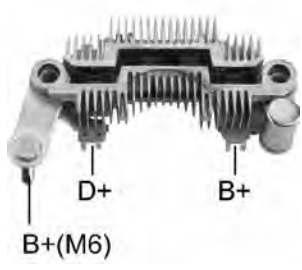
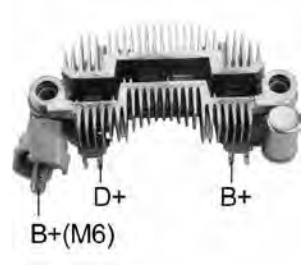
Tester

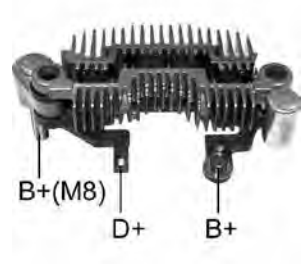
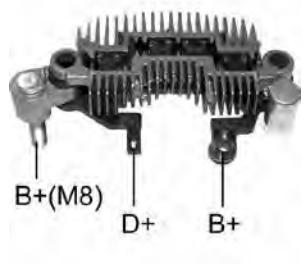
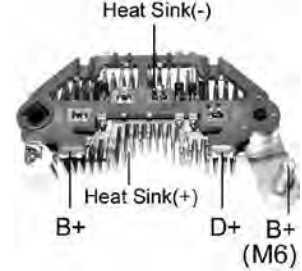
 <p>RM-117 *90mm Mtg. Length *M6 Battery Post *8-30 Amp diodes</p> <p>Unit No. HYUNDAI : 37300-22200</p> <p>B+(M6) D+ B+</p>	 <p>RM-118 *90mm Mtg. Length *M6 Battery Post *6-30 Amp diodes</p> <p>Unit No. HYUNDAI : AB170094, OK2A2-18300</p> <p>B+(M6) D+ B+</p>
 <p>RM-123 *108mm OD *6-35 Amp Diodes *w/diode trios</p> <p>Replaces VALEO : 136738,809162,811875, A600C0231,IMR5005</p> <p>Unit No. MANDO : A00B0431,AC15515, AC155515,AC155603...</p>	 <p>RM-132 *M8 Battery Post *6-50A Avalanche Diodes</p> <p>Replaces MANDO : TA600C13301</p> <p>Unit No. MANDO : AB180128</p> <p>B+(M8)</p>
 <p>RM-133 *90mm Mtg. Length *M8 Battery Post *8-30A Amp Diodes</p> <p>Unit No. HYUNDAI : 37300-38310 MANDO : AB195126</p> <p>B+(M8) D+ B+</p>	 <p>RM-144 *M8 Battery Post *8-30 Amp Diodes</p> <p>Unit No. MANDO : AB112112,AB112145</p> <p>B+(M8) D+ B+</p>
 <p>Heat Sink(-) Heat Sink(+)</p> <p>RM-198 *M6 Battery Post *8-30 Amp Diodes</p> <p>Unit No. HYUNDAI : 37300-22200 MANDO : AB190058</p> <p>B+ D+ B+ (M6)</p>	

- Brush Holder
- Voltage Regulator
- Repair Circuit
- Rectifier
- Diode Trio
- Diode
- Tester



B+(M5)

RM-01HV

- *65mm Mtg. Length
- *M5 Battery Post
- *O.E. Compatible Design with 6-50 Amp Diodes
- *RM-01 With Block Diodes

Replaces

MAZDA : FE65-24-510,B101-18-W60,B603-18-W60...
MITSUBISHI : A860T11970,A860T13370,A860T21770...
MITSUBISHI MOTORS : MD607828

Unit No.

FORD : E7GZ-10346A
MAZDA : B603-18-300,B603-18-300A,F356-18-300A...
MITSUBISHI : A1T40391,A1T40491,A5T30574,A5T30977...
MITSUBISHI MOTORS : MD069978,MD074992



B+(M5)

RM-02HV

- *65mm Mtg. Length
- *M5 Battery Post
- *O.E. Compatible Design with 6-50A Diodes
- *RM-02 With Block Diodes

Replaces

FORD : E7GY-10304A
MAZDA : E356-18-W60,FE65-18-W60,FE65-18-W60A
MITSUBISHI : A860T17470,A860T17870

Unit No.

MITSUBISHI : A5T16471,A5T30574,A5T30977,A5T31177...



B+(M6)

RM-03HV

- *65mm Mtg. Length
- *M6 Battery Post
- *O.E. Compatible Design with 6-50A Diodes
- *RM-03 With Block Diodes

Replaces

MITSUBISHI : A860T22770
SUBARU : 23830-KA070

Unit No.

MITSUBISHI : A1T02592
SUBARU : 23700-KA190,23700-KA240,23700-KA360



B+

D+

RM-04HV

- *65mm Mtg. Length
- *O.E. Compatible Design with 6-50 Amp Diodes
- *RM-04 With Block Diodes

Replaces

MITSUBISHI : A860T16770
MITSUBISHI MOTORS : MD611254

Unit No.

HYUNDAI : 37700-21030,37700-21320
MANDO : AR160A
MITSUBISHI : A1T01991,A1T40791,A1T40891
MITSUBISHI MOTORS : MD091849,MD091850



B+(M6)

RM-05HV

- *65mm Mtg. Length
- *M6 Battery Post
- *O.E. Compatible Design with 6-50 Amp Diodes
- *RM-05 With Block Diodes

Replaces

MITSUBISHI : A860T20570
NISSAN : 23124-53A10

Unit No.

MITSUBISHI : A5T41592,A5T41592B
NISSAN : 23100-53A10,23100-53A11

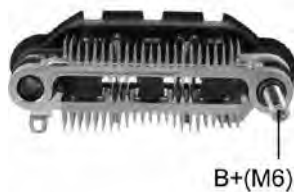

B+(M6)

RM-06

- *75mm Mtg. Length
- *M6 Battery Post
- *6-30 Amp Diodes

Replaces

MITSUBISHI : A860T13070,A860T13870,A860T17170
NISSAN : 23124-04F10,23124-05P10,23230-04F10

Unit No.

MITSUBISHI : A2T45272,A2T45272A,A2T48176,A2T48195A...
NISSAN : 23100-04F01,23100-04F10,23100-04F11...



RM-07HV
 *75mm Mtg. Length
 *O.E. Compatible Design with
 6-50 Amp Diodes
 *RM-07 With Block Diodes

Replaces
MITSUBISHI : A860T13170,A860T16970,A860T22570...
MITSUBISHI MOTORS : MD607917,MD611256,MD611688
Unit No.
MITSUBISHI : A2T00991,A2T02271,A2T02471,A2T03471...
MITSUBISHI MOTORS : MD073067,MD074644,MD082419,
 MD09179

Brush Holder

Voltage Regulator

Repair Circuit

Rectifier

Diode Trio

Diode

Tester



RM-08HV
 *75mm Mtg. Length
 *M5 Battery Post
 *O.E. Compatible Design with
 6-50 Amp Diodes
 *RM-08 With Block Diodes

Replaces
FORD : E98Z-10304A
MAZDA : E5D3-18-W60A,F811-18-W60,FE79-18-W60
MITSUBISHI : A860T17570,A860T17970,A860T24270
Unit No.
MAZDA : B612-18-300A,B617-18-300,FE68-18-300C...
MITSUBISHI : A2T13471,A2T40374,A2T40377,A2T41674...



RM-09HV
 *75mm Mtg. Length
 *O.E. Compatible Design with
 6-50 Amp Diodes
 *RM-09 With Block Diodes

Replaces
MITSUBISHI : A860T17270,A860T17285
NISSAN : 23124-08E16
Unit No.
MITSUBISHI : A2T46395,A2T46395B,A2T48292,A2T48298
NISSAN : 23100-26E10,23100-26E11,23100-26E60...



RM-100
 *85mm Mtg. Length
 *6-30 Amp diodes
 *O.E. Compatible
Unit No.
MITSUBISHI : A2T13391C,
 A2T13391D,A2T13391E



RM-105
 *71mm Mtg. Length
 *6-35 Amp Diodes
Replaces
MITSUBISHI : A860T06470
Unit No.
MITSUBISHI : A1T70379



RM-10HV
 *75mm Mtg. Length
 *M6 Battery Post
 *O.E. Compatible Design with
 6-50 Amp Diodes
 *RM-10 With Block Diodes

Replaces
FORD : E8GY-10304B,E92Z-10304A
MAZDA : B675-18-W60,F8B1-18-W60
MITSUBISHI : A860T27170
Unit No.
FORD : E8GY-10346C,E8GY-10346D,E92Z-10346A
MANDO : AB175015,AB175019
MAZDA : B675-18-300A,B675-18-300B,F202-18-300...
MITSUBISHI : A2T05772,A2T05892,A2T05893,A2T09493



RM-11
 *75mm Mtg. Length
 *6-30 Amp Diodes

Replaces
MITSUBISHI : A860T17770
MITSUBISHI MOTORS : MD611307
Unit No.
FORD : E8GY-10346B
MAZDA : B655-18-300A
MITSUBISHI : A2T03072,A2T03892,A2T09792,A2T13571...
MITSUBISHI MOTORS : MD106508,MD106713,MD108305,
 MD11715

Brush Holder



B+(M8)

RM-110HV

*85mm Mtg. Length
 *M8 Battery Post
 *O.E. Compatible Design with
 6-50 Amp Diodes

Replaces

MITSUBISHI : A860T57870

Unit No.

MAZDA : Z599-18-300A
MITSUBISHI : A2TB0091

Voltage Regulator



B+(M5)

RM-112HV

*85mm Mtg. Length
 *M5 Battery Post
 *O.E. Compatible Design with
 6-50 Amp Avalanche Diodes

Unit No.

MITSUBISHI : A2TG4891A



B+(M5)

RM-115

*85mm Mtg. Length
 *M5 Battery Post
 *8-30 Amp Diodes

Unit No.

MITSUBISHI : A2TB6291

Repair Circuit



B+(M8x28)

RM-116

*100mm Mtg. Length
 *6-30 Amp Diodes
 *M8 Battery Post
 *O.E. Compatible

Replaces

MITSUBISHI : A860X47070
MITSUBISHI MOTORS : ME701716

Unit No.

MITSUBISHI : A3T08699,A3T08799,A3T09698,A3T09699...



B+(M6)

RM-119H

*M6 Battery Post
 *8-35 Amp diodes
 ** For Iran Market Only **

Replaces

KIA : KK137-24-W60

Rectifier

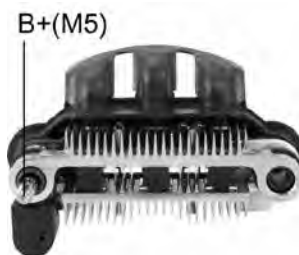

B+(M5)

RM-12

*75mm Mtg. Length
 *M5 Battery Post
 *6-30 Amp Diodes

Replaces

MITSUBISHI : A860T20270
NISSAN : 23124-58L10

Unit No.

FORD : E7GZ-10346A,E804-10346B,E8GY-10346B
HYUNDAI : 37900-21030
MAZDA : B601-18-300,B603-18-300,B655-18-300...
MITSUBISHI : 86651830,A2T02394,A2T02394B,A2T13571...
NISSAN : 23100-07F11,23100-12C10,23100-12C11

Diode Trio



B+(M8)

RM-120

*85mm Mtg. Length
 *M8 Battery Post
 *W/D+ Terminal, W/Phase
 Terminal
 *8-30 Amp Diodes

Unit No.

MITSUBISHI : A4T40286,A4T40289,A4T40386,A4TU3085...
MITSUBISHI MOTORS : ME011886 ,ME077788,ME077789 ,ME092

Diode

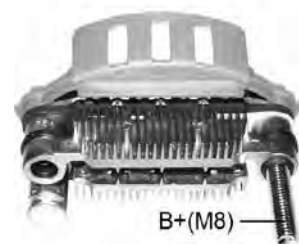

B+(M8)

RM-124

*75mm Mtg. Length
 *M8 Battery Post
 *6-30 Amp diodes
 *O.E. Compatible

Replaces

MITSUBISHI : A860T46570,A860X46570
MITSUBISHI MOTORS : MD618844

Unit No.

HYUNDAI : 37300-02503
MANDO : AB160108
MITSUBISHI : A1T06391,A1T06672,A1TA0091,A1TA0291...
MITSUBISHI MOTORS : MD300720,MD305885,MD311138,MD31171

Tester

 <p>RM-125HV *100mm Mtg. Length *M6 Battery Post *O.E. Compatible Design with 8-50 Amp Diodes</p> <p>Unit No. CHRYSLER : 4609075</p> <p>B+(M6)</p>	 <p>RM-126 *85mm Mtg. Length *M6 Battery Post *6-30 Amp diodes *O.E. Compatible</p> <p>Unit No. MITSUBISHI : A2TB1491, A2TB1941ZC</p>
 <p>RM-127 *100mm Mtg. Length *M6 Battery Post *8-30 Amp diodes *O.E. Compatible</p> <p>B+(M6)</p>	<p>Replaces MITSUBISHI : A860X79470</p> <p>Unit No. MAZDA : GY011-8300E, GY011-8300R, GY011-8W9XA MITSUBISHI : A3TB1081, A3TG2681</p>
 <p>RM-128 *85mm Mtg. Length *M8 Battery Post *8-30 Amp diodes *O.E. Compatible</p> <p>Unit No. MITSUBISHI : A2TA5391, A2TB5791 MITSUBISHI MOTORS : MD317862</p> <p>B+(M8)</p>	 <p>RM-129 *75mm Mtg. Length *M5 Battery Post *6-30 Amp diodes</p> <p>Replaces MITSUBISHI : 230261</p> <p>Unit No. HONDA : 31100-P2EA02, 31100-PEJ004 MITSUBISHI : A5TA0091, A5TA0991ZC</p> <p>B+(M5)</p>
 <p>RM-129A *75mm Mtg. Length *M5 Battery Post *6-30 Amp diodes *w/o Trio *w/o Capacitor</p> <p>B+(M5+)</p>	<p>Replaces MITSUBISHI : A860X70970</p> <p>Unit No. MITSUBISHI : A5TA3891, A5TA3891A, A5TA4591 SUZUKI : 31400-66D00, 31400-66D01</p>
 <p>RM-130 *85mm Mtg. Length *M5 Battery Post *6-30 Amp Diodes</p> <p>Replaces MITSUBISHI : A860X61970 SUBARU : 23830-AA130</p> <p>Unit No. MITSUBISHI : A2TA7691 SUBARU : 23700-AA290</p> <p>B+(M5)</p>	 <p>RM-131HV *100mm Mtg. Length *M6 Battery Post *O.E. Compatible Design with 8-50A Diodes *RM-131 With Block Diodes</p> <p>Unit No. CHRYSLER : 4606075, 4609300 MITSUBISHI : A3T14292, A3TA4191, A3TA4191ZC</p> <p>B+(M6X32)</p>
 <p>RM-134 *100mm Mtg. Length *M8 Battery Post *8-30 Amp diodes *O.E. Compatible</p> <p>Unit No. FORD : XF52-10300AC, XF5Z-10346AA MITSUBISHI : A3TA5691, A3TA5691ZC NISSAN : 23100-7B000</p> <p>B+(M8)</p>	 <p>RM-135 *85mm Mtg. Length *M6 Battery Post *6-30 Amp diodes *w/o diode trios *O.E. Compatible</p> <p>Unit No. MITSUBISHI : A2TB2991</p> <p>B+(M6)</p>

Brush Holder

Voltage Regulator

Repair Circuit

Rectifier

Diode Trio

Diode

Tester

Brush Holder

Voltage Regulator

Repair Circuit

Rectifier

Diode Trio

Diode

Tester



RM-136
 *75mm Mtg. Length
 *M6 Battery Post
 *8-30 Amp Diodes

Replaces
MITSUBISHI : A860X83370

Unit No.
HONDA : 31100-PLM-A01,
 31100-PLM-A012...
MITSUBA : A5TA7091,A5TA7191

B+(M6)



RM-139
 *100mm Mtg. Length
 *6-30 Amp Diodes
 *M8 Battery Post
 *O.E. Compatible

Unit No.
MITSUBISHI : A3TB3491
MITSUBISHI MOTORS :
 MD373093

B+(M8)



RM-14
 *75mm Mtg. Length
 *M6 Battery Post
 *8-30 Amp Diodes
 *O.E. Compatible

Replaces
MITSUBISHI : A860T27270
NISSAN : 23124-77A10

Unit No.
MITSUBISHI : A5T00192
NISSAN : 23100-77A10

B+(M6)



RM-143
 *85mm Mtg. Length
 *M5 Battery Post
 *6-50 Avalanche Diodes
 *O.E. Compatible

Unit No.
MITSUBISHI : A2TA1991F

B+(M5)



RM-145
 *75mm Mtg. Length
 *M5 Battery Post
 *8-30 Amp Diodes
 *O.E. Compatible

Unit No.
GM : 30020754
MITSUBISHI :
 A5TA2491,A5TA2491ZC,
 A5TA4291,A5TA4291ZC

B+(M5)



RM-146
 *100mm Mtg. Length
 *8-30 Amp Diodes
 *M8 Battery Post
 *w/ diode trios
 *O.E. Compatible

Replaces
MITSUBISHI : A860X61870

Unit No.
MITSUBISHI : A3TA4298

B+(M8)



RM-147
 *75mm Mtg. Length
 *M6 Battery Post
 *8-30 Amp diodes
 *w/ diode trios
 *O.E. Compatible

Replaces
MITSUBISHI : A860T30370

Unit No.
MITSUBISHI : A001T03191,A001T04495,A1T03191ZC

B+(M6)

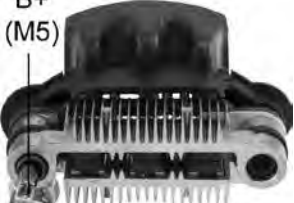

RM-15
 *65mm Mtg. Length
 *M5 Battery Post
 *6-30 Amp Diodes
 *O.E. Compatible

Replaces
ECHLIN : AC82
FORD : E7GZ-10304A
HONDA : 31127-PE0-0340
LUCAS : 21513129,UBJ200
MAGNETI MARELLI : 940038255
MAZDA : FE65-18-W60A,FE65-24-510
MITSUBISHI : A860T11970,A860T13370,A860T17470...
MITSUBISHI MOTORS : MD607828

Unit No.
MAZDA : B603-18-300A,E356-18-300A,F651-18-300...
MITSUBISHI : A1T40391,A5T30574,A5T30871,A5T30977...
MITSUBISHI MOTORS : MD069978,MD074992

B+(M5)



RM-151
 *M8 Battery Post
 *8-50A Avalanche Diodes

Unit No.
VALEO : TA000A-48401,TA000A-48402

B+(M8)



RM-152
 *85mm Mtg. Length
 *M8 Battery Post
 *8-30 Amp Diodes
 *O.E. Compatible

B+(M8)

Replaces
 MITSUBISHI : A860X49270
 MITSUBISHI MOTORS : MD618950
Unit No.
 MITSUBISHI : A2TN0076,A2TN1199,A2TN1481,A2TN1798...

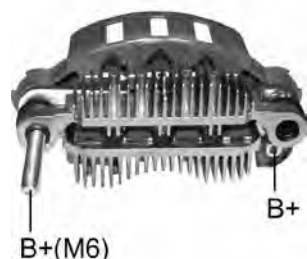

RM-153
 *85mm Mtg. Length
 *M6 Battery Post
 *8-30 Amp diodes
 *O.E. Compatible
Unit No.
 MITSUBISHI : A2TG0191,
 A2TG0191ZC

B+(M6)

B+

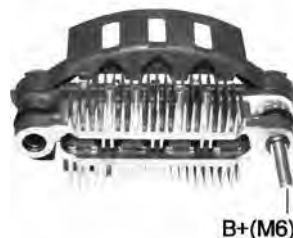

RM-154HV
 *85mm Mtg. Length
 *M6 Battery Post
 *O.E. Compatible Design with
 8-50A Amp Diodes
Replaces
 HONDA : 31127-PGM-004
Unit No.
 HONDA : 31100-PND-004,AHGA53,
 AHGA55,AHGA65
 MITSUBISHI : A2TB7951

B+(M6)



RM-155HV
 *100mm Mtg. Length
 *M5 Battery Post
 *O.E. Compatible Design with
 8-50A Avalanche Diodes
Unit No.
 CITROEN : 9640088080
 MITSUBISHI : A3TB2691

B+(M5)

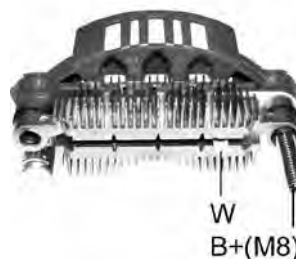

RM-157H
 *100mm Mtg. Length
 *M8 Battery Post
 *O.E. Compatible Design with
 8-35A Diodes
Replaces
 MITSUBISHI : A860X52670
 MITSUBISHI MOTORS :
 ME701570

W
 B+(M8)



RM-158H
 *75mm Mtg. Length
 *M6 Battery Post
 *O.E. Compatible Design with
 6-35A Diodes
Unit No.
 HONDA : 31100-RSH-004
 MITSUBISHI : A5TB1391

B+(M6)



RM-159
 *85mm Mtg. Length
 *M8 Battery Post
 *8-30 Amp Diodes
Unit No.
 MITSUBISHI : A2TG0281
 NISSAN : 23100-DC000

B+(M8)



RM-16
 *75mm Mtg. Length
 *M5 Battery Post
 *6-30 Amp Diodes
 *O.E. Compatible
Replaces
 MITSUBISHI : A860T27070
Unit No.
 MAZDA : B675-18-300C
 MITSUBISHI : A2T05772

B+(M5)

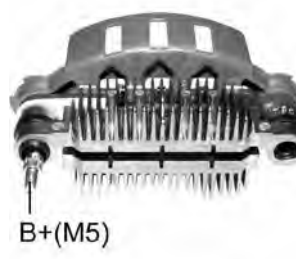

RM-161HV
 *85mm Mtg. Length
 *M5 Battery Post
 *O.E. Compatible Design with
 6-50A Diodes
Unit No.
 MITSUBISHI : A2TG-1081ZT
 NISSAN : 23100-EB71A

B+(M5)

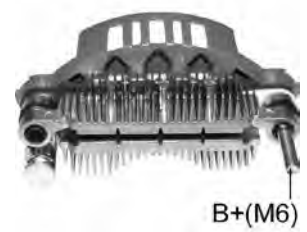

RM-165H
 *100mm Mtg. Length
 *M6 Battery Post
 *O.E. Compatible Design with
 8-50A Diodes
Unit No.
 MITSUBISHI : A3T04999,
 A3T06099
 MITSUBISHI MOTORS :
 MD135825,MD147246

B+(M6)

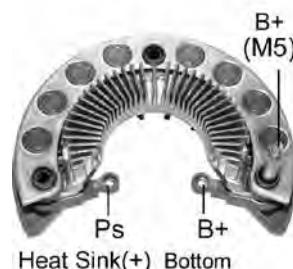

RM-168
 *128mm OD
 *M5 x 0.8 Battery Post Term,
 Knurled
 *16-35A Avalanche Diodes
Unit No.
 MITSUBISHI : A3TJ0781
 NISSAN : 23100-EB315

Ps B+
 Heat Sink(+) Bottom

Brush Holder
 Voltage Regulator
 Repair Circuit
 Rectifier
 Diode Trio
 Diode
 Tester

Brush Holder

Voltage Regulator

Repair Circuit

Rectifier

Diode Trio

Diode

Tester

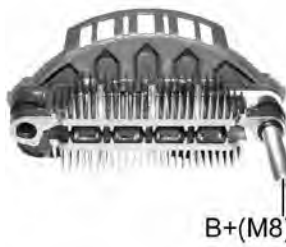

RM-169HV
 *100mm Mtg. Length
 *M8 Battery Post
 *O.E. Compatible Design with 8-50A Diodes

Unit No.
MITSUBISHI : A004TA8191, A4TA8191

B+(M8)



RM-170
 *100mm Mtg. Length
 *M8 Battery Post
 *8-35 Amp Diodes

Replaces
MITSUBISHI : A860X52570
MITSUBISHI MOTORS : ME701569

Unit No.
MITSUBISHI : A3T75883, A3TN5188

B+(M8)

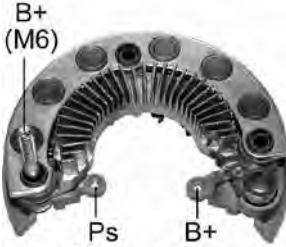

RM-175
 *115mm OD
 *M6 Battery Post
 *12-50A Amp Diodes

Unit No.
HONDA : AHGA77,31100-RB0-004
MITSUBISHI : A5TJ0091

B+(M6)
 Ps
 B+
 Heat Sink(+) Bottom



RM-176
 *75 mm Mtg. Length
 *M8 Battery Post
 *8-35 Amp Diodes
 *O.E. Compatible

Unit No.
MITSUBISHI : A5TG0091

B+(M8)



RM-178C
 *122mm OD
 *M8 Battery Post
 *12-50A Avalanche Diodes

Unit No.
MITSUBISHI : A002TX2581ZD, A2TX2581ZC

Heat Sink(-)
 Heat Sink(+)
 B+
 B+(M8)
 Ps

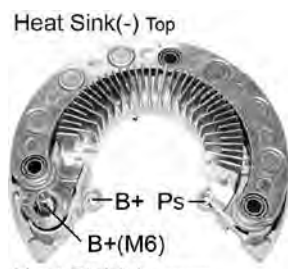

RM-178HD
 *122mm OD
 *M6 Battery Post
 *12-70A Avalanche Diodes

Unit No.
FORD : 8S4T-10300AA, 8S4Z-10346A
MITSUBISHI : A2TX0191ZC

Heat Sink(-) Top
 B+ Ps
 B+(M6)
 Heat Sink(+) Bottom

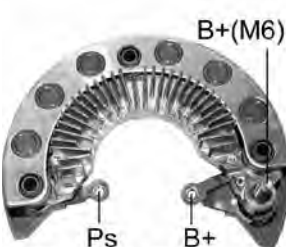

RM-179
 *130mm OD
 *M6 Battery Post
 *12-50A Avalanche Diodes

Replaces
MITSUBISHI : 94675-C1323-7920H

Unit No.
MITSUBISHI : A3TJ1791,A3TJ1791ZC,A003TJ3691,A3TJ3691...
NISSAN : 23100-JA11A,23100-JA11AR,23100-1AA1A...

B+(M6)
 Ps
 B+
 Heat Sink(+) Bottom



RM-18
 *75mm Mtg. Length
 *M5 Battery Post
 *6-30 Amp Diodes

Replaces
MITSUBISHI : A860T19370
MITSUBISHI MOTORS : MD611501

Unit No.
MITSUBISHI : A2T01077,A2T01976,A2T17783,A2T49577
MITSUBISHI MOTORS : MD099621,MD105606

B+(M5)

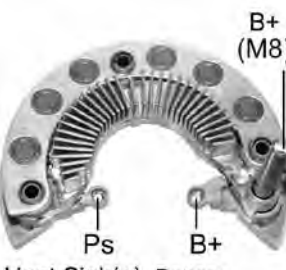

RM-180HV
 *122mm OD
 *M8 Battery Post
 *12-50 Amp Diodes

Unit No.
MITSUBISHI : A2TJ0481, A2TJ0481ZC,A002TJ0281, A2TJ0281...
NISSAN : 23100-EM01B, 23100-JD200,23100-JN81A...





B+(M8)
 Ps
 B+
 Heat Sink(+) Bottom



RM-181
 *85mm Mtg. Length
 *M5 Battery Post
 *8-30 Amp diodes
 *O.E. Compatible

Unit No.
HONDA : 31100-RNA-A01
MITSUBISHI : A2TC1391

B+(M5)

 <p>RM-182 *100mm Mtg. Length *M5 Battery Post *8-35 Amp diodes *O.E. Compatible</p> <p>Unit No. MAZDA : LF1F-18-300 MITSUBISHI : A3TG4791, A3TG2491,A3TG2491ZC</p> <p>B+(M5)</p>	 <p>RM-183H *100mm Mtg. Length *8-50 Amp Diodes *M5 Battery Post</p> <p>Unit No. HYUNDAI : 37300-42354, 37300-42356</p> <p>B+(M5)</p>	<p>Brush Holder</p>
 <p>RM-184 *100mm Mtg. Length *M5 Battery Post *6-50A Avalanche Diodes *O.E. Compatible</p> <p>Unit No. MITSUBISHI : A3TG2391 SUBARU : 23700-AA55A</p> <p>B+(M5)</p>	 <p>RM-185 *85mm Mtg. Length *M5 Battery Post *8-35 Amp Diodes *O.E. Compatible</p> <p>Unit No. MITSUBISHI : A2TB2891,A2TB2891ZC SUBARU : 23700-AA370, 23700-AA37A</p> <p>B+(M5)</p>	<p>Voltage Regulator</p>
 <p>RM-187H *100mm Mtg. Length *M5 Battery Post *8-35 Amp Diodes</p> <p>Unit No. FORD : 2S6T-10300DB, 2S6U-10300GB</p> <p>B+(M5)</p>	 <p>RM-189H *135mm OD *M6 Battery Post *16-50 Avalanche Diodes</p> <p>Replaces MITSUBISHI : A860T88170</p> <p>Unit No. FORD : 4W73-10300AC, 4W7Z-10346AC,FW73-10346AC MITSUBISHI : A4TJ0181, A4TJ0181ZC</p> <p>Ps B+ Heat Sink(+) Bottom</p>	<p>Repair Circuit</p>
 <p>RM-19 *75mm Mtg. Length *M5 Battery Post *6-30 Amp Diodes</p> <p>Replaces MITSUBISHI : A860T24570</p> <p>Unit No. MITSUBISHI : A2T03591,A2T036 91,A2T03791,A2T03792 MITSUBISHI MOTORS : MD111151</p> <p>B+(M5)</p>	 <p>RM-190HV *122mm OD *M6 Battery Post *12-50 Amp Diodes</p> <p>Unit No. MITSUBISHI : A2TJ0391,A2TJ03 91A,A2TJ0391B,A2TJ0391C</p> <p>Ps B+ Heat Sink(+) Bottom</p>	<p>Rectifier</p>
 <p>RM-192 *128mm OD *12-50 Amp Diodes *M5 Battery Post</p> <p>Replaces MITSUBISHI : A860X85670</p> <p>Unit No. MITSUBISHI : A3TJ0191</p> <p>Ps B+ Heat Sink(+) Bottom</p>	 <p>RM-193HD *100mm Mtg. Length *M8 Battery Post *8-50A Avalanche Diodes</p> <p>Unit No. MITSUBISHI : A3TG4191, A003TG4191</p>	<p>Diode Trio</p>
 <p>RM-194 *128mm OD *M8 Battery Post *16-35A Avalanche Diodes</p> <p>Unit No. MITSUBISHI : A3TJ0691 NISSAN : 23100-EG010</p> <p>Heat Sink(-) Top Heat Sink(+) Bottom Ps B+ B+(M8)</p>	 <p>RM-199 *128mm OD *M8 Battery Post *12-50A Avalanche Diodes</p> <p>Replaces NISSAN : 23124-JK01A</p> <p>Unit No. CHRYSLER : 4801477AA MITSUBISHI : A3TJ2581,A3TJ19 91,A3TJ1991A,A3TJ1991B NISSAN : 23100-JK01A, 23100-3FY1A</p> <p>Heat Sink(-) Top Heat Sink(+) Bottom Ps B+ B+(M8)</p>	<p>Diode</p>
<p>For more reference information please see Cross Reference List at the front of the catalogue All maker's names & nummers are used for reference purposes only.</p>		<p>Tester</p>

Brush Holder

Voltage Regulator

Repair Circuit

Rectifier

Diode Trio

Diode

Tester

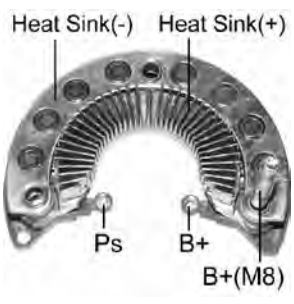

RM-200
 *135mm OD
 *M8 Battery Post
 *16-50A Avalanche Diodes

Unit No.
MITSUBISHI : A4TJ0282
RENAULT : 8200654785

Heat Sink(-) Heat Sink(+)
 Ps B+
 B+(M8)



RM-201
 *M8 Battery Post
 *6-50A Avalanche Diodes

Unit No.
MITSUBISHI : A3TG1991,
 A3TG4091

B+(M8)



RM-202
 *75mm Mtg. Length
 *M6 Battery Post
 *6-50 Amp Diodes

Unit No.
MITSUBISHI : A5TA6292F,
 A5TA6292G,A5TG0881ZEB
PEUGEOT : V757695680

B+(M5)

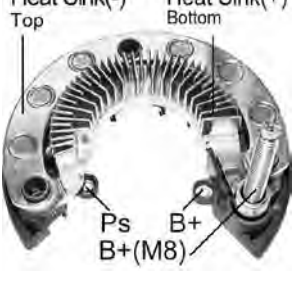

RM-203
 *122mm OD
 *M8 Battery Post
 *12-50A Avalanche Diodes

Unit No.
CHRYSLER : 04801490AA,
 4801490AA
MITSUBISHI : A2TX0281

Heat Sink(-) Heat Sink(+)
 Top Bottom
 Ps B+
 B+(M8)

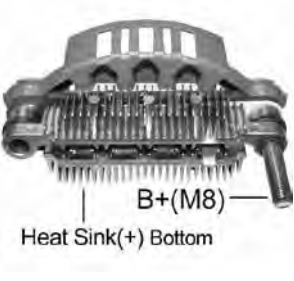

RM-205
 *100mm Mtg. Length
 *M8 Battery Post
 *8-35 Amp Diodes

Unit No.
MITSUBISHI : A3TR0188ZT
MITSUBISHI MOTORS :
 ME192608

B+(M8)
 Heat Sink(+)
 Bottom

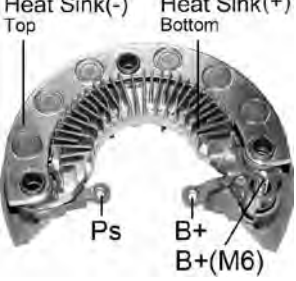

RM-207
 *128mm OD
 *M6 Battery Post
 *12-50A Avalanche Diodes

Unit No.
MITSUBISHI : A3TJ1791A,
 A3TU1791B
NISSAN : 23100-1AA1B

Heat Sink(-) Heat Sink(+)
 Top Bottom
 Ps B+
 B+(M6)

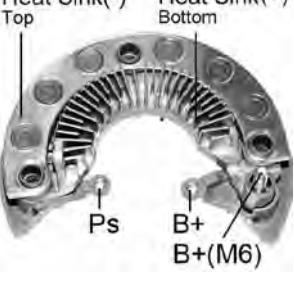

RM-208
 *128mm OD
 *M6 Battery Post
 *12-50 Amp Diodes

Unit No.
FORD : 6E5T-10300BA,
 6E5T-10300BD,6E5Z-10346BA...
MITSUBISHI : A3TJ0991,
 A3TJ0991ZC

Heat Sink(-) Heat Sink(+)
 Top Bottom
 Ps B+
 B+(M6)



RM-209
 *75mm Mtg. Length
 *M6 Battery Post
 *6-30 Amp diodes

Unit No.
MITSUBISHI : A5T06591

B+(M6)
 Heat Sink(+)
 Bottom



RM-20HV
 *75mm Mtg. Length
 *M6 Battery Post
 *O.E. Compatible Design with
 6-50 Amp Diodes
 *RM-20 With Block Diodes

B+(M6)

Replaces
MITSUBISHI MOTORS : MD611479

Unit No.
MITSUBISHI : A2T01384,A2T01483,A2T01583,A2T01683...
MITSUBISHI MOTORS : MD103372,MD103373,MD103564,
 MD10631



RM-210HV
 *100mm Mtg. Length
 *M8 Battery Post
 *8-35 Amp Diodes

Unit No.
MITSUBISHI : A4TR5191ZT
RENAULT : 5001866377,
 5010480765
SCANIA : 1516176,1525447

Heat Sink(+)
 Top
 B+(M8)

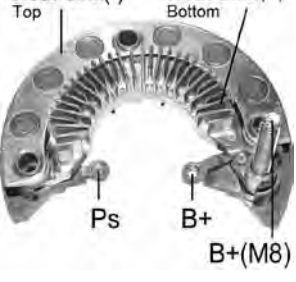

RM-213
 *128mm OD
 *M8 Battery Post
 *12-50A Avalanche Diodes

Unit No.
MITSUBISHI : A3TJ2481
NISSAN : 23100-JD71A

Heat Sink(-) Heat Sink(+)
 Top Bottom
 Ps B+
 B+(M8)

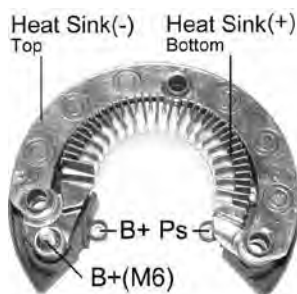

RM-216HD

*128mm OD
*M6 Battery Post
*12-70A Avalanche Diodes

Unit No.

FORD : BL1T-10300BB,BL1Z-10346A
MITSUBISHI : A003TX0692ZC,A3TX0692ZC



RM-22

*75mm Mtg. Length
*M6 Battery Post
*8-30 Amp Diodes

Replaces

MAZDA : B3C7-18-W60
MITSUBISHI : A860T39770,A860T37070,A860X45670
NISSAN : 23124-OE711,23124-OE712

Unit No.

GM : 96058486
MITSUBISHI : A1T03195,A5T07091
SUZUKI : 31400-60A20

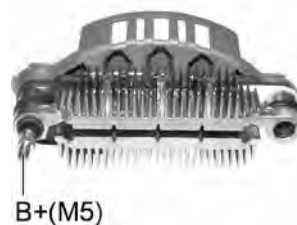

RM-220HV

*100mm Mtg. Length
*6-50A Avalanche Diodes
*M5 Battery Post

Unit No.

MITSUBISHI : A3TG1891,
A3TG5281ZEB
PEUGEOT : V757692180

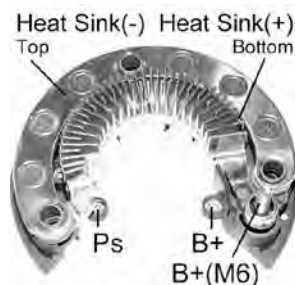

RM-221

*122mm OD
*M6 Battery Post
*12-50A Avalanche Diodes

Unit No.

MITSUBISHI : A2TX1781,
A2TL0091
SUBARU : 23700-AA700

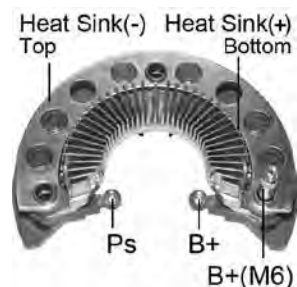

RM-222HV

*135mm OD
*M6 Battery Post
*12-50A Avalanche Diodes

Replaces

MITSUBISHI : 88375-21274-5531Y

Unit No.

MITSUBISHI : A4TJ0084C

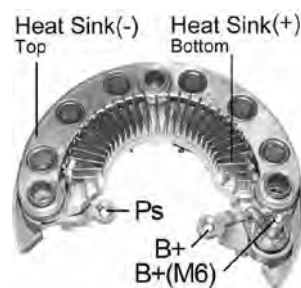

RM-224

*115mm OD
*M6 Battery Post
*12-50 Avalanche Diodes

Replaces

MITSUBISHI : A4982-C1771-2518Y

Unit No.

HONDA : 31100-R1A-A01
MITSUBISHI : A5TJ0191ZD



RM-226HV

*85mm Mtg. Length
*M5 Battery Post
*O.E. Compatible Design with
8-50 Amp Diodes

Unit No.

MAZDA : ZJ38-18-300
MITSUBISHI : A2TG1391ZD,A11578MI,A2TG1391,A002TG1391...



RM-23

*75mm Mtg. Length
*M5 Battery Post
*8-30 Amp Diodes

Replaces

MAZDA : B61P-18-W60,B64J-18-W60
MITSUBISHI : A860T32570,A860T37770,A860T37870...

Unit No.

MAZDA : BP02-18-300
MITSUBISHI : A5T00877,A5T01577,A5T01977,A5T02777...

Brush Holder

Voltage Regulator

Repair Circuit

Rectifier

Diode Trio

Diode

Tester



RM-231HV
 *100mm Mtg. Length
 *M8 Battery Post
 *O.E. Compatible Design with 8-50 Amp Diodes

Replaces
MITSUBISHI : A860X64570
NISSAN : 23124-4P116

Unit No.
MITSUBISHI : A3TA7991

B+(M8)

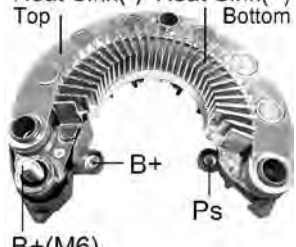

RM-233
 *115mm OD
 *M6 Battery Post
 *12-50 Avalanche Diodes

Unit No.
MITSUBISHI : A5TL0581ZC, AHGA88

Heat Sink(-) Top, Heat Sink(+) Bottom, B+(M6), Ps

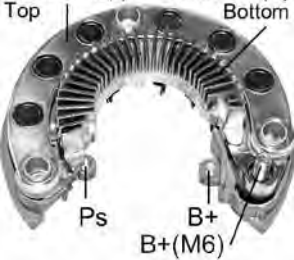

RM-237
 *115mm OD
 *M6 Battery Post
 *12-50A Avalanche Diodes

Unit No.
MITSUBISHI : A6182-C2119-3912Y, A005TL0491, A5TL0491

Heat Sink(-) Top, Heat Sink(+) Bottom, Ps, B+(M6)

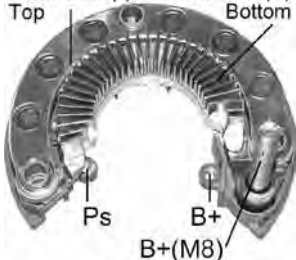

RM-238
 *115mm OD
 *M8 Battery Post
 *12-50A Avalanche Diodes

Unit No.
MITSUBISHI : A5TL0191A, A005TL0191A
NISSAN : 23100-1HH1A

Heat Sink(-) Top, Heat Sink(+) Bottom, Ps, B+(M8)

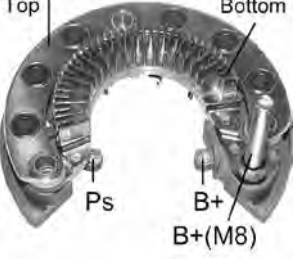

RM-239
 *128mm OD
 *M8 Battery Post
 *12-50A Avalanche Diodes

Unit No.
MITSUBISHI : A3TX0481

Heat Sink(-) Top, Heat Sink(+) Bottom, Ps, B+(M8)



RM-24
 *75mm Mtg. Length
 *M5 Battery Post
 *6-30 Amp Diodes

Replaces
MITSUBISHI : A860X20099

Unit No.
MITSUBISHI : A2T07577, A2T34794A, A2T47794
NISSAN : 23100-0H611

B+(M5)

RM-240
 *64mm Mtg. Length
 *M8 Battery Post
 *8-50 Amp diodes

Unit No.
MITSUBISHI : A7TA3377

PICTURE IS NOT AVAILABLE

RM-245HD

Unit No.
FORD : FL1T-10300-AA, FL1Z-10346-A
MITSUBISHI : A003TV0691ZC

PICTURE IS NOT AVAILABLE

RM-246

Unit No.
GM : 13506528

PICTURE IS NOT AVAILABLE



RM-27
 *75mm Mtg. Length
 *8-30 Amp Diodes

Replaces
MITSUBISHI : A860T38570

Unit No.
HONDA : 31100-P00-014
MITSUBISHI : A5T04292



RM-28
 *75mm Mtg. Length
 *M5 Battery Post
 *8-30 Amp Diodes

Replaces
MITSUBISHI : A866X45281

Unit No.
MITSUBISHI : A5T06391

B+(M5)



RM-29HV
 *85mm Mtg. Length
 *O.E. Compatible Design with
 6-50 Amp Diodes
 *RM-29 With Block Diodes

Replaces
FORD : E8PZ-10301B
MITSUBISHI : A860T28670
Unit No.
FORD : E83F-10300AA,E83F-10300AB,E83F-10300BA...
MITSUBISHI : A3T01596,A3T01598



B+(M6)

RM-30
 *85mm Mtg. Length
 *M6 Battery Post
 *6-30 Amp Diodes

Replaces
FORD : E8PZ-10304A,GYE1379
MITSUBISHI : A860T28770
Unit No.
FORD : E8SF-10300AA,E8SF-10346A
MITSUBISHI : A3T01496



B+(M6)

RM-31
 *85mm Mtg. Length
 *M6 Battery Post
 *6-30 Amp Diodes

Replaces
MAZDA : F825-18-W60,JE15-18-W60
MITSUBISHI : A860T31370,A860T34070
Unit No.
MAZDA : F285-18-300C,JE15-18-300A
MITSUBISHI : A2T13977,A2T19677,A2T19877,A2T19991...



B+(M5)

RM-33
 *85mm Mtg. Length
 *M5 Battery Post
 *8-30 Amp Diodes

Unit No.
MITSUBISHI : A3T01691
SUBARU : 23700-AA060



B+(M6)

RM-34HV
 *85mm Mtg. Length
 *M6 Battery Post
 *O.E. Compatible Design with
 8-50 Amp Diodes
 *RM-34 With Block Diodes

Replaces
MITSUBISHI : A860T23270
MITSUBISHI MOTORS : MD611586
Unit No.
MITSUBISHI : A3T00692,A3T04292
MITSUBISHI MOTORS : MD112323



B+(M6)

RM-36
 *85mm Mtg. Length
 *M6 Battery Post
 *6-30 Amp Diodes

Replaces
MITSUBISHI : A860T38770
MITSUBISHI MOTORS : MD618568
Unit No.
MITSUBISHI : A2T34892,A2T34992,A2T35091,A2T35092...
MITSUBISHI MOTORS : MD175810,MD175811,MD177244,MD18427

Brush Holder



RM-37
 *85mm Mtg. Length
 *M8 Battery Post
 *6-30 Amp Diodes

Unit No.
MITSUBISHI : A2T20091

B+(M8)



RM-38
 *85mm Mtg. Length
 *M5 Battery Post
 *6-30 Amp Diodes

Replaces
MITSUBISHI : A860T38270

Unit No.
MITSUBISHI : A2T17574,
 A2T18874,A2T34477

B+(M5)

Voltage Regulator



RM-39HV
 *85 mm Mtg. Length
 *M5 Battery Post
 *O.E. Compatible Design with
 6-50 Amp Diodes
 *RM-39 With Block Diodes

B+(M5x18)

Replaces
MAZDA : B366-18-W60
MITSUBISHI : A860T39170,A860T37670

Unit No.
MITSUBISHI : A2T33991,A2T35177

Repair Circuit



Heat Sink(+)

RM-40
 *100mm Mtg. Length
 *8-30 Amp Diodes

Heat Sink(-)

Replaces
MITSUBISHI : A860T23070,A860T28070
MITSUBISHI MOTORS : MD611564,MD611768

Unit No.
MITSUBISHI : A3T02192,A3T02193,A3T03391,A3T03392...
MITSUBISHI MOTORS : MD111233,MD126110,MD133171,
 MD13683

Rectifier

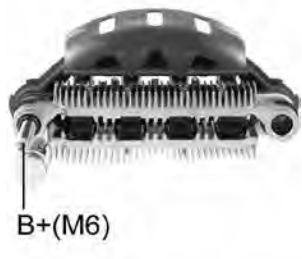

RM-41
 *100mm Mtg. Length
 *M6 Battery Post
 *8-30 Amp Diodes

B+(M6)

Replaces
FORD : E9PZ-10304B
MITSUBISHI : A860T35270

Unit No.
FORD : E9SF-10300DA
HYUNDAI : AB175020
MITSUBISHI : A4T00796
MOTORCRAFT : GLE-265

Diode Trio



RM-42
 *100mm Mtg. Length
 *M5 Battery Post
 *8-30 Amp Diodes

B+(M5)

Replaces
MITSUBISHI : A860T30170
SUBARU : 23830-AA030

Unit No.
MITSUBISHI : A3T03891
SUBARU : 23700-AA061

Diode



RM-43
 *100mm Mtg. Length
 *M6 Battery Post
 *8-30 Amp Diodes
 *w/diode trios

B+(M6)

Replaces
FORD : E9PZ10304B
MITSUBISHI : A860T26070,137486,A600C10301,A860T23070...
VALEO : 137486

Unit No.
MITSUBISHI : A4T01493,A4T01893,A4T03191
MITSUBISHI MOTORS : MD150657,MD197470

Tester



B+(M6)

RM-44

- *100mm Mtg. Length
- *M6 Battery Post
- *8-30 Amp Diodes

Replaces

MITSUBISHI : A860T31770,A860X31799,A860X34799

Unit No.

MITSUBISHI : A3T05192



B+(M8)

RM-45

- *100mm Mtg. Length
- *M8 Battery Post
- *8-30 Amp Diodes

Replaces

MAZDA : JE48-18-W60B
MITSUBISHI : A860T36770

Unit No.

MAZDA : JE48-18-300
MITSUBISHI : A3T07592



Heat Sink(+)
(Bottom) B+(M5)

RM-46

- *100mm Mtg. Length
- *M5 Battery Post
- *8-30 Amp Diodes

Replaces

MAZDA : K801-18-W60,N3A1-18-W60,135902
MITSUBISHI : A860T38670,A860T40270

Unit No.

MAZDA : K801-18-300C
MITSUBISHI : A3T08491,A3T08591



B+(M6)

RM-47

- *100mm Mtg. Length
- *M6 Battery Post
- *8-30 Amp Diodes
- *O.E. Compatible

Replaces

MITSUBISHI : A860T42070

Unit No.

FORD : F3LU-10300BC
MITSUBISHI : A3T41591



B+(M8)

RM-48

- *100mm Mtg. Length
- *M8 Battery Post
- *8-30 Amp Diodes

Replaces

MITSUBISHI : A860T33970

Unit No.

FORD : F3XA-10300AB,F3XA-10300AC
MITSUBISHI : A4T02591
NISSAN : 23100-0B000



B+(M8)

RM-50HV

- *85mm Mtg. Length
- *M8 Battery Post
- *O.E. Compatible Design with 6-50 Amp Diodes
- *RM-50 With Block Diodes

Replaces

MITSUBISHI : A860T42670,A860T42770
MITSUBISHI MOTORS : MD618734,MD618752

Unit No.

MITSUBISHI : A2T33891,A2T38391
MITSUBISHI MOTORS : MD190819,MD198164,MD306649



B+(M6x32)

RM-53HV

- *85mm Mtg. Length
- *M6 Battery Post
- *O.E. Compatible Design with 8-50 Amp Diodes
- *RM-53 With Block Diodes

Replaces

CHRYSLER : 138893
MITSUBISHI : 138893

Unit No.

CHRYSLER : 4686106,4609101,4609125,4609320,4661998...
MITSUBISHI : A2T81192,A2T81292,A2T81391,A2TA7491

Brush Holder

Voltage Regulator

Repair Circuit

Rectifier

Diode Trio

Diode

Tester

Brush Holder



RM-54HV

- *100mm Mtg. Length
- *M5 Battery Post
- *O.E. Compatible Design with 8-50 Amp Diodes
- *RM-54 With Block Diodes

Unit No.
FORD : F3LY-10346A

B+(M5)

Voltage Regulator



RM-57

- *85mm Mtg. Length
- *M8 Battery Post
- *Same as RM-37 except RM-57 is 8-30 Amp Diodes

Replaces
MITSUBISHI : A860T32170

Unit No.
MITSUBISHI : A2T34991,A2T35092,A2T38891,A2T38892...
MITSUBISHI MOTORS : MD175810,MD175811,MD177244,MD18427

B+(M8)

Repair Circuit



RM-58

- *85mm Mtg. Length
- *M5 Battery Post
- *Same as RM-39 except RM-58 is 8-30 Amp Diodes

Replaces
MITSUBISHI : A860T38970

Unit No.
MITSUBISHI : A2T33191

B+(M5)

Rectifier



RM-59

- *85mm Mtg. Length
- *Same as RM-50 except RM-59 is 8-30 Amp Diodes
- *M8 Battery Post
- *w/diode trios

Replaces
FORD : F32Z-10304A
MAZDA : FS11-18-W60
MITSUBISHI : A860T39070,A860X44170
MITSUBISHI MOTORS : MD618811

Unit No.
FORD : F32Z-10346A
MITSUBISHI : A2T33891,A2T38392,A2T80591,A2T82791...
MITSUBISHI MOTORS : MD194482,MD304129,MD306649,MD31099

B+(M8)

Diode Trio



RM-59HV

- *85mm Mtg. Length
- *Same as RM-50HV except RM-59HV is 8-50 Amp Diodes
- *M8 Battery Post
- *w/diode trios
- *O.E. Compatible Design

Replaces
FORD : F32Z-10304A
MAZDA : FS11-18-W60
MITSUBISHI : A860T39070,A860X44170,A860X42770
MITSUBISHI MOTORS : MD618811

Unit No.
FORD : F32Z-10346A
MITSUBISHI : A2T33891,A2T38392,A2T80591,A2T82791...
MITSUBISHI MOTORS : MD194482,MD304129,MD306649,MD31099

B+(M8)

Diode

Tester



RM-60

- *71mm Mtg. Length
- *6-35 Amp Diodes

Replaces
LUCAS : 21511124
MAZDA : D401-24-510
MITSUBISHI : A860T04370,A860T05070,A860T11070
MITSUBISHI MOTORS : MD607429
NISSAN : 23124-B9810

Unit No.
MITSUBISHI : 3066857101,3446826100,3446828100...
NISSAN : 23100-01W10,23100-06T10,23100-B9810...

B+

D+

**RM-62**

*71mm Mtg. Length
*6-35 Amp Diodes

Replaces

MAZDA : D401-24-510B
MITSUBISHI : A860T11270,134373

Unit No.

MAZDA : D501-18-300,GE01-18-300
MITSUBISHI : A1T23277,A1T23377,A1T31371,A1T31374...

**RM-63**

*71mm Mtg. Length
*6-35 Amp Diodes

Replaces

MAZDA : D501-24-510,GE01-24-510
MITSUBISHI : A860T07170

Unit No.

MAZDA : D401-18-300,H612-18-300
MITSUBISHI : A1T23377,A1T31374,A1T31377,A1T3377

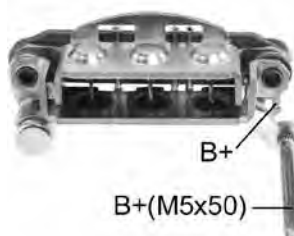
**RM-65**

*80mm Mtg. Length
*6-35 Amp Diodes

Replaces

LUCAS : 21513130,UBJ256
MAGNETI MARELLI : 940038257
MITSUBISHI : A860T08270
MITSUBISHI MOTORS : MD607616

Unit No.

MITSUBISHI : A5T15584,A5T15684,A5T15784,A5T15884...
MITSUBISHI MOTORS : MD013740,MD061818,
MD068565,MD06985

**RM-66**

*80mm Mtg. Length
*6-35 Amp Diodes

Replaces

LUCAS : 21513107,UBJ257
MAZDA : N221-24-510
MITSUBISHI : A860T06070,A860T06082,A860T06470
MITSUBISHI MOTORS : MD607568

Unit No.

MAZDA : HE45-18-300,N221-18-300
MITSUBISHI : A5T10271,A5T15171,A5T15177,A5T15371...
MITSUBISHI MOTORS : MD015040,MD015041,
MD034130,MD03413

**RM-67**

*80mm Mtg. Length
*6-35 Amp Diodes

Replaces

LUCAS : 21513134
MAZDA : E356-24-510,E563-24-510
MITSUBISHI : A860T10770

Unit No.

MAZDA : E331-18-300A,E563-18-300A,E5A1-18-300A
MITSUBISHI : A5T21471,A5T21472,A5T30171

**RM-68**

*85mm Mtg. Length
*6-35 Amp Diodes

Replaces

LUCAS : 21513100,UBJ219
MAGNETI MARELLI : 940038247
MAZDA : 8173-24-510
MITSUBISHI : A860T03970,A860T05170
MITSUBISHI MOTORS : MD607370,MD607441

Unit No.

MAZDA : 8341-18-300,8492-18-300,E303-18-300
MITSUBISHI : A2T12371,A2T12671,A2T16371,A2T16471...
MITSUBISHI MOTORS : MD006187,MD006197,MD007509,
MD00905
NISSAN : 23100-D0111,23100-H7711,23100-H9011...

**RM-69**

*85mm Mtg. Length
*6-35 Amp Diodes

Replaces

MAZDA : 8173-24-510A
MITSUBISHI : A860T07270

Unit No.

MAZDA : 1480-18-300,8173-18-300B,E302-18-300
MITSUBISHI : A2T23471,A2T23474,A2T23477,A2T23494...

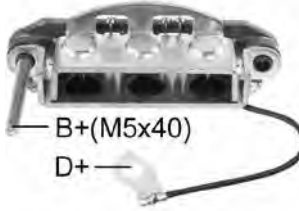
**RM-71**

*85mm Mtg. Length
*6-35 Amp Diodes

Replaces

MAZDA : 8599-24-510
MITSUBISHI : A860T06370

Unit No.

MITSUBISHI : 859918300,A2T25479,A2T25679,S50218300C

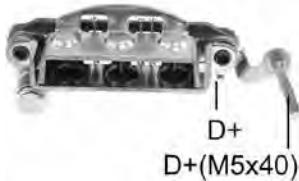
**RM-73**

*85mm Mtg. Length
*6-35 Amp Diodes

Replaces

LUCAS : 21513105,UBJ302
MAZDA : S215-24-510
MITSUBISHI : A860T08770,A860T15170
MITSUBISHI MOTORS : MD607680,ME700636,ME700836
NISSAN : 23230-04D00

Unit No.

MAZDA : RF03-18-300C
MITSUBISHI : A002T72576,A2T27176,A2T27376,A2T40483...
MITSUBISHI MOTORS : MD050190,MD061430,MD087246,MD60768
NISSAN : 23100-04D00,23100-04D01

**RM-74**

*100mm Mtg. Length
*6-35 Amp Diodes

Replaces

LUCAS : 21513128
MAZDA : 4130-24-510B,FE05-24-510
MITSUBISHI : A860T10370,A860T11370
MITSUBISHI MOTORS : MD607818

Unit No.

MAZDA : 8356-18-300,8574-18-300,FE05-18-300B...
MITSUBISHI : A3T21278,A3T21677,A3T34077,A3T34391...
MITSUBISHI MOTORS : MD086046,MD086047,MD086048
NISSAN : 23100-05P11

**RM-75**

*100mm Mtg. Length
*6-35 Amp Diodes

Replaces

LUCAS : 21513102,UBJ208
MAGNETI MARELLI : 940038246
MAZDA : 4130-24-510A,4130-24-560,E301-24-510A
MITSUBISHI : A860T04170,A860T05270,A860T07370...
MITSUBISHI MOTORS : MD607385,MD607529
NISSAN : 23124-Q4610

Unit No.

MAZDA : 4119-18-300,4130-18-300,4199-18-300...
MITSUBISHI : A2T25171,A2T26172,A3T21277,A3T21278...
MITSUBISHI MOTORS : MD018230,MD022576,MD025677,MD02567
NISSAN : 23100-D0211,23100-P3016,23100-Q0811...

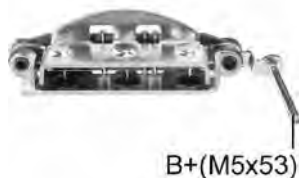
**RM-76**

*100mm Mtg. Length
*6-35 Amp Diodes

Replaces

LUCAS : 21511121,UBJ220
MAGNETI MARELLI : 940038256
MITSUBISHI : A860T11770
NISSAN : 23124-05E16

Unit No.

MITSUBISHI : A003T35278,A003T35299A,A3T35278
NISSAN : 23100-05E17,23100-05E18,23100-05E70

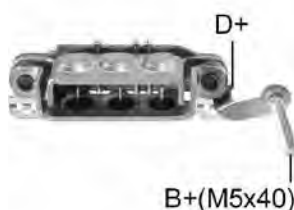
**RM-78**

*71mm Mtg. Length
*6-35 Amp Diodes

Replaces

MAZDA : S205-24-510
MITSUBISHI : A86T08570

Unit No.

MAZDA : S515-18-300,SE45-18-300,SL01-18-300...
MITSUBISHI : A1T33576,A1T33676,A1T71076,A1T71176...
MITSUBISHI MOTORS : S51518300,SE4518300,
SL0118300,SL0718

**RM-80**

*100mm Mtg. Length
*M5 Battery Post
*6-30 Amp Diodes
*O.E. Compatible

Replaces

MITSUBISHI : A860T26470

Unit No.

MITSUBISHI :
A3T01877,A3T01877A

**RM-81**

*64mm Mtg. Length
*6-30 Amp Diodes
*O.E. Compatible

Replaces

MITSUBISHI :
A860T18870,A860T18899
NISSAN : 23124-17B10

Unit No.

MITSUBISHI : A5T01892,A5T229
71B,A5T22997,A5T22997B

**RM-82**

*100mm Mtg. Length
*M8 Battery Post
*8-30 Amp Diodes
*O.E. Compatible

Unit No.

MITSUBISHI : A4T02891,A4T02891A,A4T02891B,A4T02892...

**RM-83**

*85mm Mtg. Length
*6-35 Amp Diodes

Replaces

MAZDA : FE01-24-510A,HE41-24-510
MITSUBISHI : A860T08370,A860T10470
MITSUBISHI MOTORS : MD607693

Unit No.

MAZDA : F601-18-300A,F807-18-300A,FE01-18-300B...
MITSUBISHI : A2T31677,A2T31977,A2T40374,A2T40377...
MITSUBISHI MOTORS : MD015020,MD015021,
MD019179,MD02567

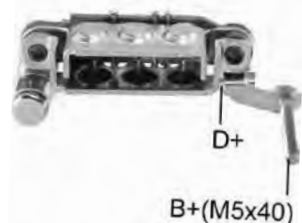
**RM-84**

*71mm Mtg. Length
*M5 Battery Post
*6-35 Amp Diodes
*For use on:
*MAZDA Titan E2500,E3000
series.

Replaces

MITSUBISHI : A860T12870

**RM-85**

*80mm Mtg. Length
*6-35 Amp Diodes

Replaces

LUCAS : 21511122
MITSUBISHI : A860T08470
NISSAN : 23124-W5811

Unit No.

MITSUBISHI : A5T00272,A5T20871,A5T20872,A5T21871...
NISSAN : 23100-05B10,23100-10B10,23100-27G10...

Brush Holder

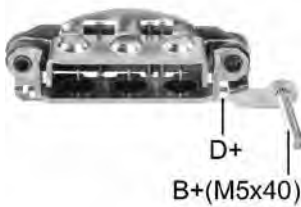

RM-86

- *80mm Mtg. Length
- *M5 Battery Post
- *6-35 Amp Diodes

B+(M5x40)

Replaces

MITSUBISHI : A860T14570
MITSUBISHI MOTORS : ME700555

Unit No.

MITSUBISHI : A5T22578,A5T22583,A5T70178,A5T70183...
MITSUBISHI MOTORS : ME001570,ME007577,
ME007578,ME01756

Voltage Regulator

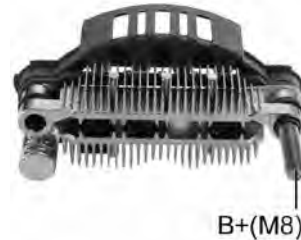

RM-87

- *100mm Mtg. Length
- *M8 Battery Post
- *6-30 Amp Diodes
- *O.E. Compatible

B+(M8)

Unit No.

MITSUBISHI : A3TA0591,
A3TA0591C,A3TA0591D,A3TA05
91E...

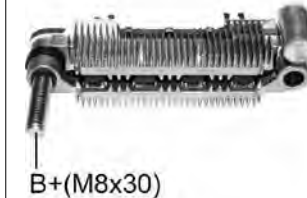

RM-89

- *100mm Mtg. Length
- *M8 Battery Post
- *8-30 Amp Diodes
- *O.E. Compatible

B+(M8x30)

Unit No.

MITSUBISHI : A4T00891,
A4T00991,A4T03392,A4T03492

Repair Circuit



RM-90

- *85mm Mtg. Length
- *M6 Battery Post
- *6-30 Amp Diodes
- *O.E. Compatible

B+(M6x32)

Unit No.

MITSUBISHI :
A2T81891,A2TA2591



RM-94

- *85mm Mtg. Length
- *M5 Battery Post
- *6-30 Amp Diodes
- *O.E. Compatible

B+(M5)

Replaces

MITSUBISHI : A860T06870

Unit No.

MITSUBISHI : A2TA1991,A2TA19
91D,A2TA1994,A2TA1994B...

Rectifier



RM-96

- *100mm Mtg. Length
- *M5 Battery Post
- *6-35 Amp Diodes

B+(M5x33)

Replaces

MITSUBISHI : A860T06270
NISSAN : 23124-W1715

Unit No.

MITSUBISHI :
A3T33678,A3T33684,A3T33698



RM-97HV

- *85mm Mtg. Length
- *M5 Battery Post
- *OE Compatible Design with
6-50 Amp Diodes
- *RM-97 With Block Diodes

B+(M5)

Replaces

MITSUBISHI : A860T41670

Unit No.

MITSUBISHI : A2T36478

Diode Trio



RM-98

- *85mm Mtg. Length
- *M5 Battery Post
- *8-30 Amp Diodes
- *Same as RM-38 except RM-
98 is with 8 diodes

B+(M5)

Replaces

MITSUBISHI : A860T33470,A860T38270

Unit No.

MITSUBISHI : A2T17574,A2T18874,A2T34477

Diode

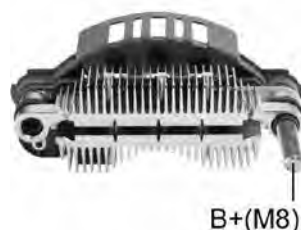

RM-99HV

- *100mm Mtg. Length
- *M8 Battery Post
- *O.E. Compatible Design with
8-50 Amp Diodes
- *RM-99 With Block Diodes

B+(M8)

Unit No.

MITSUBISHI : A3TN1791

Tester

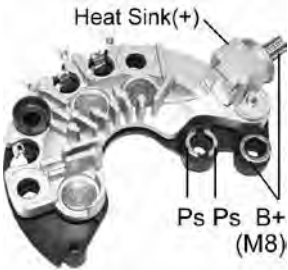
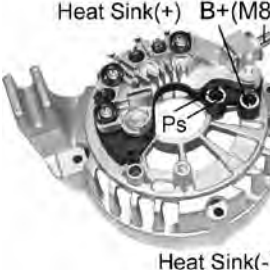
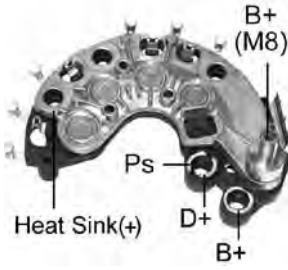
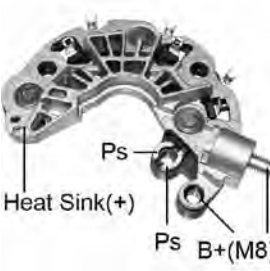
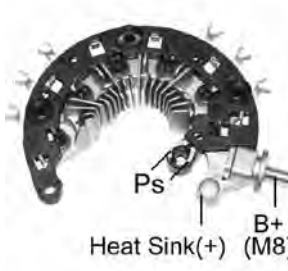
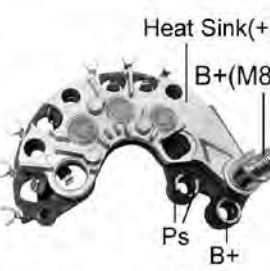
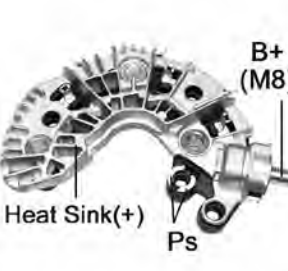
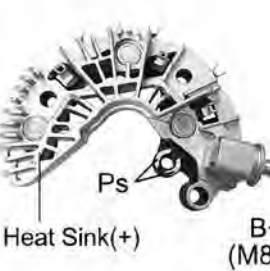
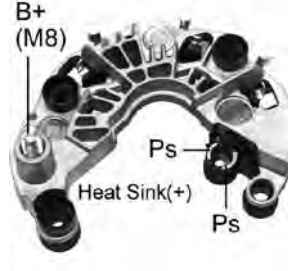
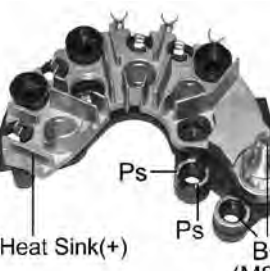
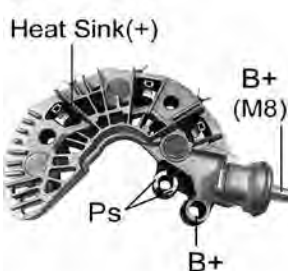
 <p>RP-42 *108mm OD *M8 Battery Post *8-50A Avalanche Diodes</p> <p>Replaces VALEO : 593512</p> <p>Unit No. VALEO : A11VI109,SG15L012,SG15L026</p>	 <p>RP-44 *103mm OD *3-50A Avalanche Diodes *Positive rectifier</p> <p>Unit No. DELCO : 10317647,10440635 VALEO : 2542558,2650010,2650016,2650135A...</p>
 <p>RP-44A *103mm OD *6-50A Avalanche Diodes *Negative & Positive Assembly</p> <p>Unit No. DELCO : 10317647,10440635 VALEO : 2542558,2650010,2650016,SG10S029...</p>	 <p>RP-52 *103mm OD *M8 Battery Post *4-50A Avalanche Diodes *Positive rectifier</p> <p>Replaces VALEO : 5498776</p> <p>Unit No. VALEO : SG10S012</p>
 <p>RP-57 *103mm OD *M8 Battery Post *3-50A Avalanche Diodes</p> <p>Replaces VALEO : 2603196</p> <p>Unit No. FORD : 7G9N-10300CC,7G9N-10300CA,AV6N-10300HA... VALEO : TG12C037,TG12C087,2606952B</p>	 <p>RP-59 *114mm OD *M8 Battery Post *6-50A Avalanche Diodes</p> <p>Unit No. BMW : 12317521178,12317525376</p>
 <p>RP-62 *M8 Battery Post *3-50A Avalanche Diodes</p> <p>Replaces VALEO : 2547906,593463</p> <p>Unit No. RENAULT : 7700430183,7701499971,8200120571...</p>	 <p>RP-65HD *103mm OD *M8 Battery Post *3-70A Avalanche Diodes</p> <p>Unit No. NISSAN : 23100-7Y020,23100-5Z020 VALEO : 2650031,2650047,TG12C0141,TG15C026</p>
 <p>RP-66 *3-50A Avalanche Diodes *Positive rectifier</p> <p>Replaces VALEO : 2650237</p>	 <p>RP-68 *111mm OD *3-50A Avalanche Diodes *M8 Battery Post *Positive rectifier</p> <p>Unit No. HYUNDAI : 37300-3C250</p>
 <p>RP-69HD *110mm OD *M8 Battery Post *3-70A Avalanche Diodes *Positive Rectifier</p> <p>Unit No. VALEO : SG14B023</p>	 <p>RP-72 *111mm OD *3-50A Avalanche Diodes *Positive rectifier</p> <p>Unit No. NISSAN : 23100-JA02A,23100-JA02B VALEO : 2650364,TG12C032</p>

Brush Holder
 Voltage Regulator
 Repair Circuit
 Rectifier
 Diode Trio
 Diode
 Tester

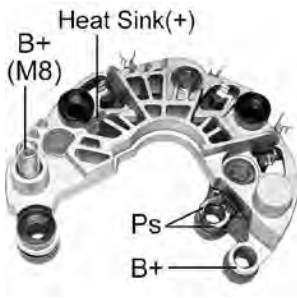

RP-80
 *111mm OD
 *M8 Battery Post
 *3-50A Avalanche Diodes
 *Positive rectifier

Unit No.
 VALEO : TG9S036

Brush Holder

Voltage Regulator

Repair Circuit

Rectifier

Diode Trio

Diode

Tester

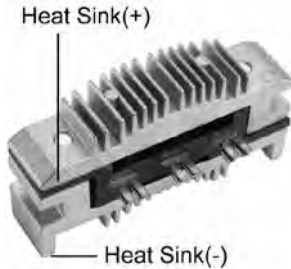
 <p>RU-01 *6-25 Amp Diodes</p> <p>Replaces VALEO : NC013,NC014 VALEO(DUCELLIER) : 581025,581071,581078,593074...</p> <p>Unit No. VALEO(DUCELLIER) : 513001A,513001B,513001C,513003A,513003</p>	 <p>Heat Sink(+)</p> <p>RU-01H *RU-01H(35A) *35 Amp Diodes</p> <p>Replaces VALEO : NC013,NC014 VALEO(DUCELLIER) : 581025,581071,581078,593074...</p> <p>Unit No. VALEO(DUCELLIER) : 513001A,513001B,513001C,513003A,513003</p> <p>Heat Sink(-)</p>

- Brush Holder
- Voltage Regulator
- Repair Circuit
- Rectifier
- Diode Trio
- Diode
- Tester

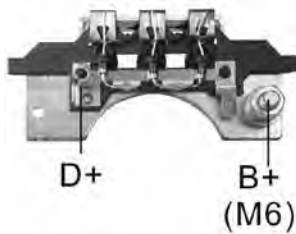

RT-01H
*6-35 Amp Diodes

Replaces

LUCAS : 21229200,UBB509
MAGNETI MARELLI : 940038290
VALEO : 2522179,501049,A418320A,NB444
VALEO(DUCELLIER) : 593068
VALEO(MOTOROLA) : 501-037,501-038,501-046,501-065...

Unit No.

VALEO(MOTOROLA) : 9AL2969F,9AR2682F,9AR2716G,
9AR2717G

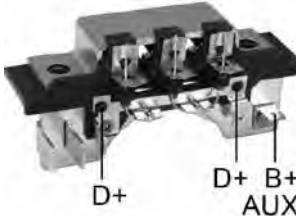

RT-02H
*6-35 Amp Diodes

Replaces

MAGNETI MARELLI : 940038287
VALEO : 2522172,2522173,NB427,NB751
VALEO(DUCELLIER) : 593070
VALEO(MOTOROLA) : 501-024,501-063

Unit No.

VALEO(MOTOROLA) : 9AR2526F,9AR2527K,9AR2528F,
9AR2605L

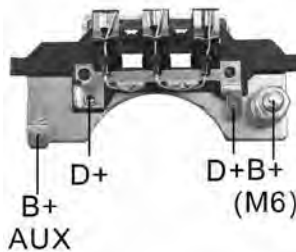

RT-03H
*6-35 Amp Diodes

Replaces

LUCAS : 21229204,UBB508
MAGNETI MARELLI : 940038289
VALEO : 2522178,NB095
VALEO(MOTOROLA) : 501-027

Unit No.

VALEO(MOTOROLA) : 9AR2662F,9AR2664F,9AR2748G,
9AR2828G

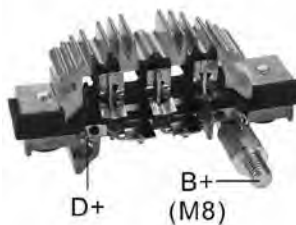

RT-04H
*6-35 Amp Diodes

Replaces

VALEO : 2522200
VALEO(MOTOROLA) : 501-104

Unit No.

VALEO(MOTOROLA) : 9AR3802L,9AR3835L,9AR6035L,
9AR6057L.

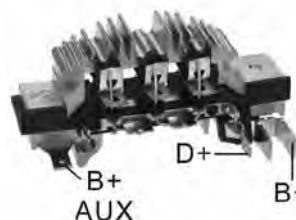

RT-05H
*6-35 Amp Diodes

Replaces

LUCAS : 21229192,21229218,UBB506,UBB513
MAGNETI MARELLI : 940038282
VALEO : 2522148,2522165,592555,NB128,NB142,NC481
VALEO(DUCELLIER) : 593073
VALEO(MOTOROLA) : 501-004,501-006,501-007,501-030...

Unit No.

VALEO(MOTOROLA) : 9AL2615G,9AL2688K,9AL2689K,
9AR11711.

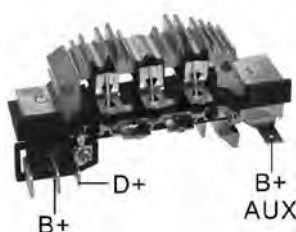

RT-06H
*6-35 Amp Diodes
*Economy Version: RT-06HA

Replaces

BOSCH : 30509
DENSO : 0260002432,0260002540,0260002680,0260002720...
ISKRA : 16905321
ISUZU : 1-81270001-0
LUCAS : 21229191,UBB505
MAGNETI MARELLI : 940038283
NIKKO : 7-44000-0900
VALEO : NB428,NB435,2522190,NB739,NB744,NB763
VALEO(DUCELLIER) : 593069,592837
VALEO(MOTOROLA) : 501-001,501-009,501-053,501-076...

Unit No.

VALEO(MOTOROLA) : 2941388,9AR2500K,9AR2506K,
9AR2511F...



RT-07H
*6-35 Amp Diodes

Replaces

LUCAS : 21229193,UBB503
MAGNETI MARELLI : 940038281,940038292
VALEO : NB117,NB120,NB122,NB123,NB136,NB436,NB439
VALEO(MOTOROLA) : 501-003,501-008,501-012,501-015...

Unit No.

VALEO(MOTOROLA) : 9AR2501K,9AR2566K,9AR2596K,
9AR2714F



RT-08H
*6-35 Amp Diodes

Replaces

LUCAS : 21229194,UBB507
MAGNETI MARELLI : 940038284
VALEO : 2522197,2522208,501077,NB126,NB138
VALEO(MOTOROLA) : 501-002,501-010,501-011,501-017...

Unit No.

VALEO(MOTOROLA) : 9AL2502K,9AL2505P,9AL2538K,
9AL2559G.



RT-09H
*6-35 Amp Diodes

Replaces

LUCAS : 21229203,UBB512
MAGNETI MARELLI : 940038286
VALEO : 2522084,501102,592254,NB787,592554
VALEO(DUCCELLIER) : 593027
VALEO(MOTOROLA) : 501-014,501-020,501-060,501-095

Unit No.

VALEO(MOTOROLA) : 9AI2617K,9AR2556K,9AR2566K,
9AR2638P.

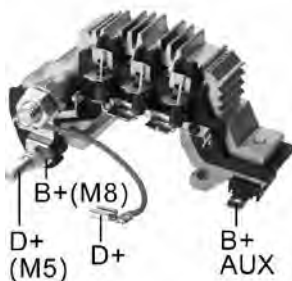

RT-10H
*6-35 Amp Diodes
*Economy Version: RT-10HA

Replaces

AUDI/VW : 036903359J
LUCAS : UBB502
MAGNETI MARELLI : 940038293
VALEO : A940677A
VALEO(MOTOROLA) : 2523321

Unit No.

AUDI/VW : 026903015E
VALEO : 026903015EV,026903015EX,026903015EY...
VALEO(MOTOROLA) : 290-300,290-301,290-302,
290-303,290-304..

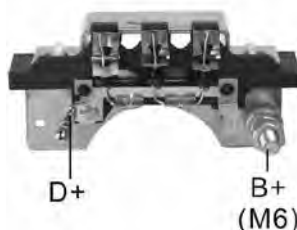

RT-12H
*6-35 Amp Diodes

Replaces

MAGNETI MARELLI : 940038288
VALEO : NB094
VALEO(MOTOROLA) : 501-023,501-026,501-054

Unit No.

VALEO(MOTOROLA) : 9AL2633G,9AL2666F,9AL2774G,
9AR2633G



RT-21H
*6-35 Amp Diodes

Replaces

LUCAS : 21229202,UBB511
VALEO : 2522190,501079,NB121,NB785
VALEO(MOTOROLA) : 501-034,501-061,501-066,501-078...

Unit No.

VALEO : 433430,433437,433453,436318,510146...

Rectifier

VALEO(MOTOROLA)



RT-23HD
*Industrial Alternator Version
*6-70 Amp Diodes
Unit No.
VALEO(MOTOROLA) : 110555



RT-24HD
*Industrial Alternator Version
*6-70 Amp Diodes
Replaces
VALEO(MOTOROLA) : 101-205
Unit No.
VALEO(MOTOROLA) : 110279,110296,110309

Brush Holder

Voltage Regulator

Repair Circuit

Rectifier

Diode Trio

Diode

Tester

**RP-01**

*115mm OD
*6-35 Amp Diodes
*With Capacitor

Replaces

DELCO REMY (LUCAS) : 21225386
LUCAS : UBB232
VALEO : NC145
VALEO(PARIS RHONE) : 101743,102527,103543,105380...

Unit No.

VALEO(PARIS RHONE) : A13N104,A13N110,A13N12,
A13N121,A13

**RP-02**

*115mm OD
*6-35 Amp Diodes
*With Capacitor, Diode Trio

Replaces

LUCAS : UBB235
VALEO : NC136,NC730,592754,593188,593199,593309
VALEO(PARIS RHONE) : 103551,181155,102556

Unit No.

VALEO(PARIS RHONE) : A13N147M,A13N148M,
A13N149M,A13N1

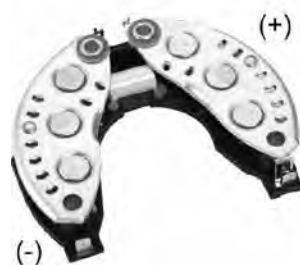
**RP-03**

*115mm OD
*6-35 Amp Diodes
*With Capacitor

Replaces

SEV MARCHAL : 71215303
VALEO : NC133,NC139,NC216,NC936
VALEO(PARIS RHONE) : 100157,101217,101759,103539...

Unit No.

SEV MARCHAL : 71635102,71635602,71635902,71636102...
VALEO(PARIS RHONE) : A13N103,A13N106,A13N113,
A13N114,A1

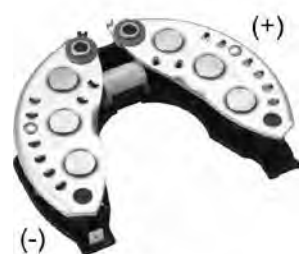
**RP-04**

*115mm OD
*6-35 Amp Diodes
*With Capacitor, Diode Trio

Replaces

DELCO REMY (LUCAS) : 21225400
SEV MARCHAL : 71215003,71215103,71215603,71216203...
VALEO : 592-596,NC138,NC388,NC877
VALEO(PARIS RHONE) : 100931,104971,350011

Unit No.

SEV MARCHAL : 71635202,71635502,71635802,71636002...
VALEO(PARIS RHONE) : A13N109,A13N129,A13N25,
A13N39,A13N

**RP-04H**

*115mm OD
*6-50 Amp Diodes
*With Capacitor

Replaces

LUCAS : UBB233
VALEO : 592595,NC144,101217,101759,103539,103576...
VALEO(PARIS RHONE) : 180537

Unit No.

VALEO(PARIS RHONE) : A13N123,A13N178,A13N179,
A14N18,A14

**RP-04HR**

*115mm OD
*6-50 Amp Diodes
*With Capacitor, Resistor,
Diode Trio

Replaces

PEUGEOT : 5744.61
VALEO(PARIS RHONE) : 105554,2181241

Unit No.

VALEO(PARIS RHONE) : A13N130,A14N80,A14N82,A14N88



RP-04R
 *115mm OD
 *6-35 Amp Diodes
 *With Resistor, Diode Trio

Replaces
 SEV MARCHAL : 71215403
 VALEO : NC134,NC217
 VALEO(PARIS RHONE) : 101773,101776,103546
Unit No.
 SEV MARCHAL : 71635702,71636202,71636302,71636402...
 VALEO(PARIS RHONE) : A13N32,A13N38,A13N40,
 A13N41,A13N42



RP-05H
 *115mm OD
 *6-50 Amp Diodes
 *With Capacitor, Diode Trio
Replaces
 VALEO(PARIS RHONE) : 101713
Unit No.
 VALEO(PARIS RHONE) :
 A14N11,A14N38,A14N71



RP-06H
 *115mm OD
 *6-50 Amp Diodes
 *With Capacitor, Diode Trio
Replaces
 VALEO : NC137
 VALEO(PARIS RHONE) :
 101227,104269
Unit No.
 VALEO(PARIS RHONE) :
 A13N11,A13N133,A13N135,
 A13N39,A13N

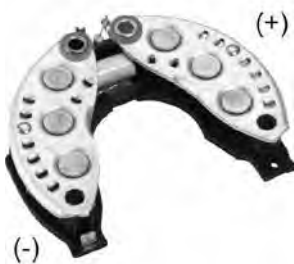

RP-06HR
 *115mm OD
 *6-50 Amp Diodes
 *With Capacitor, Resistor,
 Diode Trio

Replaces
 VALEO : NC161
 VALEO(PARIS RHONE) : 101342
Unit No.
 VALEO(PARIS RHONE) : A13N22T,A13N28T,A13N32T,
 A13N3T,A13

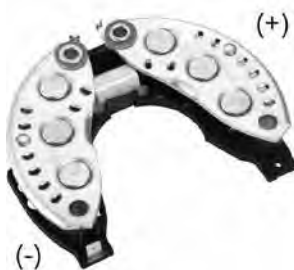

RP-07
 *115mm OD
 *6-35 Amp Diodes
 *With Capacitor

Replaces
 LUCAS : UBB237
 VALEO : NC141,592881
 VALEO(PARIS RHONE) : 105252,105690
Unit No.
 VALEO(PARIS RHONE) : A13N171,A13N62,A13N88



RP-08
 *115mm OD
 *6-35 Amp Diodes
 *With Capacitor

Replaces
 LUCAS : UBB238
 VALEO : NC143,592880,593190,593193
 VALEO(PARIS RHONE) : 104615,105522,105523,106016
Unit No.
 VALEO(PARIS RHONE) : A13N107,A13N108,
 A13N112,A13N117,A1



RP-09
 *115mm OD
 *6-35 Amp Diodes
 *With Capacitor, Diode Trio

Replaces
 DELCO REMY (LUCAS) : 21225379
 VALEO : NC976
 VALEO(PARIS RHONE) : 592747,592749
Unit No.
 VALEO(PARIS RHONE) : A13N181,A13N182,
 A13N183,A13N218,A1

Brush Holder

Voltage Regulator

Repair Circuit

Rectifier

Diode Trio

Diode

Tester

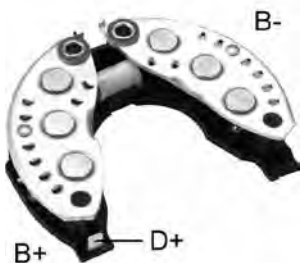

RP-09A

*115mm OD
*6-35 Amp Diodes
*Cut D+ Terminal

Unit No.

VALEO(PARIS RHONE) : A13N220



RP-09R

*115mm OD
*6-35 Amp Diodes
*With Capacitor, Resistor, Diode Trio

Replaces

VALEO : NC142
VALEO(PARIS RHONE) : 105813,592747

Unit No.

VALEO(PARIS RHONE) : A13N167,A13N181,A13N182, A13N95,A14



RP-10

*6-25 Amp Diodes

Replaces

VALEO : NC124
VALEO(PARIS RHONE) : 92086,92785,92919,92928,92939

Unit No.

VALEO(PARIS RHONE) : A11R1,A11R2,A11R3,A11R4, A12R1,A12R



RP-11

*4-35 Amp Diodes

Replaces

VALEO : NC126
VALEO(PARIS RHONE) : 78810,92734,94450,96314

Unit No.

VALEO(PARIS RHONE) : A11M10,A11M14,A12M1, A12M10,A12M18



RP-13

*107mm OD
*6-50A Avalanche Diodes
*w/o Diode Trio

Replaces

CITROEN : 95644506,5744C9
LUCAS : UBB254

Unit No.

VALEO : 2541356,2541360,2541361,2541362,2541455...
VALEO(PARIS RHONE) : A11VI15,A11VI16,A11VI17, A11VI18,A11V



RP-14

*107mm OD
*M8 Battery Post
*8-50A Avalanche Diodes

Replaces

LUCAS : UBB250,UBB251,UBB253
MAGNETI MARELLI : 940038315,940038326
PEUGEOT : 5744.02
VALEO : NF006
VALEO(PARIS RHONE) : 2546062,2546076,592844,592917...

Unit No.

VALEO : 1541683,1541696,1541697,2541348,2541473...
VALEO(PARIS RHONE) : A13VI134,A13VI135, A13VI137,A13VI138..



RP-15

*107mm OD
*M8 Battery Post
*6-50A Avalanche Diodes

Replaces

VALEO : 592845

Unit No.

VALEO(PARIS RHONE) : A11VI10,A11VI11,A11VI23, A11VI24,A11V



RP-16

*107mm OD
*M8 Battery Post
*6-50A Avalanche Diodes
*w/diode trio
*Same as RP-24 but without spade W terminal

Replaces

VALEO : 592842

Unit No.

VALEO(PARIS RHONE) : A13VI126

Brush Holder

Voltage Regulator

Repair Circuit

Rectifier

Diode Trio

Diode

Tester



RP-17
 *107mm OD
 *M6/M8 Battery Post
 *8-50A Avalanche Diodes

Replaces
 LUCAS : UBB252
 MAGNETI MARELLI : 940038316
 VALEO : NF007
 VALEO(PARIS RHONE) : 2545941,545940,592846,592847
Unit No.
 VALEO(PARIS RHONE) : A11VI104,A11VI105,
 A11VI106,A11VI107..



RP-19
 *115mm OD
 *6-35 Amp Diodes
 *Same as RP-03 except RP-19 is without Capacitor

Replaces
 VALEO(PARIS RHONE) : 102817
Unit No.
 VALEO(PARIS RHONE) : A13N37,A13N62,A13N69,
 A13N76,A14N19



RP-20
 *6-35 Amp Diodes

Replaces
 LUCAS : UBB256
 VALEO(PARIS RHONE) : 300903
Unit No.
 VALEO(PARIS RHONE) : A14N104,A14N124,A14N140,
 A14N67,A14



RP-21
 *8-35 Amp Diodes
 *Same as RP-20 but w/8 diodes

Replaces
 VALEO(PARIS RHONE) : 300903
Unit No.
 VALEO(PARIS RHONE) : A14N104,A14N124,A14N140,
 A14N67,A14



RP-22
 *107mm OD
 *M6/M8 Battery Post
 *6-50A Avalanche Diodes

Replaces
 VALEO : 593175
Unit No.
 VALEO(PARIS RHONE) : A11VI54,A11VI76,
 A11VI77,A11VI79



RP-23
 *107mm OD
 *M8 Battery Post
 *8-50A Avalanche Diodes

Replaces
 VALEO : 593174,593329,593306
Unit No.
 VALEO(PARIS RHONE) : A13VI118



RP-24
 *107mm OD
 *M8 Battery Post
 *6-50A Avalanche Diodes
 *w/diode trio
 *Same as RP-16 but w/ spade W terminal

Replaces
 VALEO : 592842
Unit No.
 VALEO(PARIS RHONE) : A13VI126



RP-27
 *107mm OD
 *M8 Battery Post
 *6-50A Avalanche Diodes
 *w/o diode trio

Replaces
 VALEO : 593320
Unit No.
 VALEO(PARIS RHONE) : A13VI178,A13VI202,
 A13VI237,A13VI257



RP-35
 *107mm OD
 *M6/M8 Battery Post
 *8-50A Avalanche Diodes

Replaces
 VALEO : 593172
Unit No.
 VALEO(PARIS RHONE) : A13VI167



RP-36
 *107mm OD
 *M8 Battery Post
 *6-50A Avalanche Diodes

Replaces
 VALEO : 546351

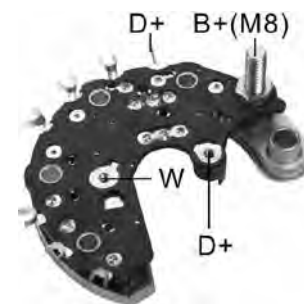

RP-37
 *107mm OD
 *M8 Battery Post
 *6-50A Avalanche Diodes
 *w/ diode trio

Replaces
 VALEO : 2546041,593202,
 2546040,592848
Unit No.
 VALEO(PARIS RHONE) : A14VI10,
 A14VI11,A14VI13,A14VI130...



RP-38
 *107mm OD
 *M8 Battery Post
 *6-50A Avalanche Diodes

Replaces
 VALEO : 2548083

Unit No.
 VALEO : 2542433A

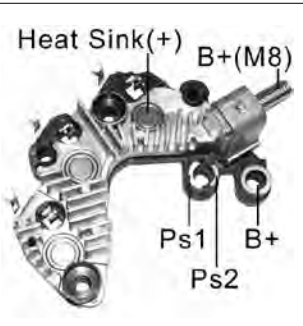

RP-39H
 *6-50A Avalanche Diodes
 *w/o Diode Trio
 *Used on Citroen C2/C3/
 Xsara, Peugeot 307

Replaces
 VALEO : 593487

Unit No.
 VALEO : 2542485A,603030256,
 9642879480



RP-40H
 *M8 Battery Post
 *6-50A Avalanche Diodes
 *w/ Diode Trio
 *Used on Renault Magnum,
 Premium, Maxter

Unit No.
 RENAULT : 5010306710
 VALEO : SG12B020,2542310

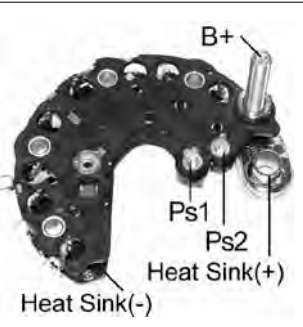

RP-41
 *8-50A Avalanche Diodes

Replaces
 VALEO : 593667

Unit No.
 VALEO :
 SG15L020,SG15L023,SG15L027

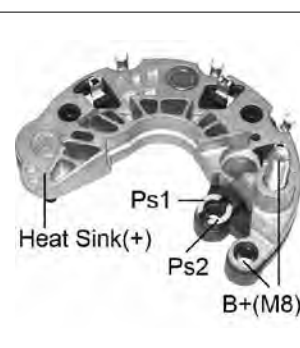

RP-43
 *103mm OD
 *M8 Battery Post
 *3-50A Avalanche Diodes
 *Positive Rectifier

Unit No.
 HYUNDAI : 37300-37405,
 37300-37400
 VALEO : 2655516,A0002655516,
 TG11C024,439295...



RP-48
 *107mm OD
 *M8 Battery Post
 *8-50A Avalanche Diodes

Replaces
 VALEO : 593366,593364,593351,
 593348,593327,593204...

Unit No.
 VALEO : A11VI110,A11VI110,
 A11VI111,A11VI187...

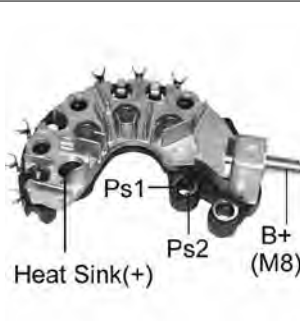

RP-51
 *103mm OD
 *M8 Battery Post
 *3-50A Avalance Diodes

Replaces
 VALEO : 593530,235653

Unit No.
 VALEO : SG10B021,SG10B022,
 SG10B023,SG10B048

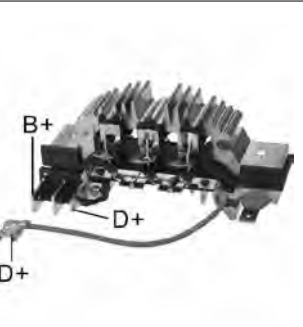

RT-19H
 *6-35 Amp Diodes
 *Economy Version: RT-19HA

Replaces
 ISKRA : 16906614

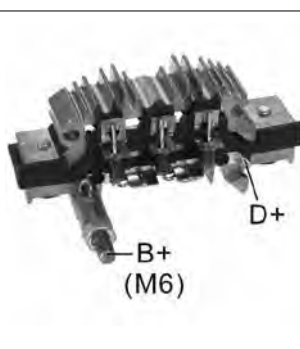

RT-20H
 *6-35 Amp Diodes
 *Economy Version: RT-20HA

Replaces
 VALEO(PARIS RHONE) : 592893

Unit No.
 VALEO(PARIS RHONE) : S13E50

Blank space for component information.

Brush Holder
 Voltage Regulator
 Repair Circuit
 Rectifier
 Diode Trio
 Diode
 Tester

DT-02

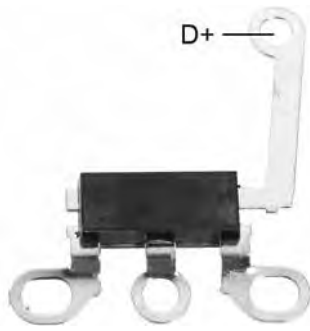

**Replaces:
DELCO**

1984032 3472312
7962635 DR3901

DT-07



**Replaces:
DUCELLIER**

669303

DT-08



**Replaces:
LUCAS**

21220361

DT-09



**Replaces:
BOSCH**

1-121-009-003 1-121-099-007
1-121-098-002 1-121-099-008
1-121-099-002 1-121-099-009
1-121-099-003 1-121-099-010
1-121-099-005 1-121-099-011
1-121-099-006

DT-13



**Replaces:
LEECE NEVILLE**

79027

DT-14



**Replaces:
LEECE NEVILLE**

79480

DT-15



**Replaces:
LEECE NEVILLE**

79026

DT-17

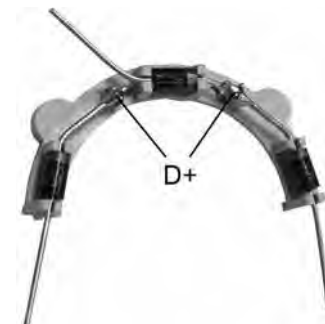

**Replaces:
BOSCH**

9-121-450-594



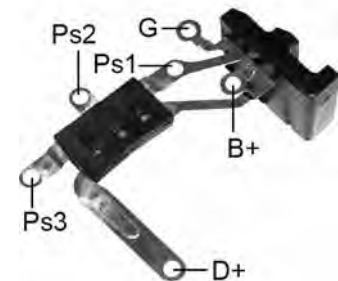



DT-18



**Replaces:
DELCO REMY/GM**

10487805

Diode

Diode Type	Part No.	Polarity	Amp	Reverse or Avalanche Voltage(V)	Reverse Leakage ($\mu\text{A}@ 25^\circ\text{C}$)	Diameter	Lead Type	Lead OD (mm)	Lead Length(mm)
Dish									
	DD-1040	-	25	400	4	8.4	Dish	1.5	23
	DD-1041	+	25	400	4	8.4	Dish	1.5	23
	DD-1085	-	35	400	4	8.4	Dish	1.5	23
	DD-1086	+	35	400	4	8.4	Dish	1.5	23
	DD-1111	-	50	400	4	8.4	Dish	1.5	23
	DD-1112	+	50	400	4	8.4	Dish	1.5	23
	DD-1113	-	25	400	4	9.5	Dish	1.5	23
	DD-1114	+	25	400	4	9.5	Dish	1.5	23
	DD-1042	-	35	400	4	9.5	Dish	1.5	23
	DD-1043	+	35	400	4	9.5	Dish	1.5	23
	DD-1071	-	50	400	4	9.5	Dish	1.5	23
	DD-1072	+	50	400	4	9.5	Dish	1.5	23
Tin Can									
	DD-1007	-	25	400	4	5/16"	Straight	1.5	26
	DD-1008	+	25	400	4	5/16"	Straight	1.5	26
	DD-1010	-	35	400	4	5/16"	Straight	1.5	26
	DD-1011	+	35	400	4	5/16"	Straight	1.5	26
	DD-1073	-	50	400	4	5/16"	Straight	1.5	26
	DD-1074	+	50	400	4	5/16"	Straight	1.5	26
	DD-1095	-	25	400	4	5/16"	Fork	1.5	26
	DD-1096	+	25	400	4	5/16"	Fork	1.5	26
	DD-1075	-	35	400	4	5/16"	Fork	1.5	26
	DD-1076	+	35	400	4	5/16"	Fork	1.5	26
	DD-1097	-	50	400	4	5/16"	Fork	1.5	26
	DD-1098	+	50	400	4	5/16"	Fork	1.5	26
Standard 1/2" Press-Fit									
	DD-1001	-	25	400	4	1/2"	Flag	1.3	
	DD-1002	+	25	400	4	1/2"	Flag	1.3	
	DD-1003	-	35	400	4	1/2"	Flag	1.3	
	DD-1004	+	35	400	4	1/2"	Flag	1.3	
	DD-1028	-	50	400	4	1/2"	Flag	1.3	
	DD-1029	+	50	400	4	1/2"	Flag	1.3	
	DD-1005	-	25	400	4	1/2"	Hook	1.3	
	DD-1006	+	25	400	4	1/2"	Hook	1.3	
	DD-1016	-	35	400	4	1/2"	Hook	1.3	
	DD-1017	+	35	400	4	1/2"	Hook	1.3	
	DD-1030	-	50	400	4	1/2"	Hook	1.3	
	DD-1031	+	50	400	4	1/2"	Hook	1.3	
	DD-1012	-	25	400	4	1/2"	Straight	1.3	33.5
	DD-1013	+	25	400	4	1/2"	Straight	1.3	33.5
	DD-1014	-	35	400	4	1/2"	Straight	1.3	33.5
	DD-1015	+	35	400	4	1/2"	Straight	1.3	33.5
	DD-1026	-	50	400	4	1/2"	Straight	1.3	33.5
	DD-1027	+	50	400	4	1/2"	Straight	1.3	33.5
	DD-1061	-	50	400	4	1/2"	Straight	2.5	23.5
	DD-1062	+	50	400	4	1/2"	Straight	2.5	23.5
	DD-1125	-	70	400	4	1/2"	Straight	2.5	23.5
	DD-1126	+	70	400	4	1/2"	Straight	2.5	23.5
	DD-1099	-	25	400	4	1/2"	Insulated	1.3	
	DD-1100	+	25	400	4	1/2"	Insulated	1.3	
	DD-1101	-	35	400	4	1/2"	Insulated	1.3	
	DD-1102	+	35	400	4	1/2"	Insulated	1.3	
	DD-1103	-	50	400	4	1/2"	Insulated	1.3	
	DD-1104	+	50	400	4	1/2"	Insulated	1.3	

Brush Holder

Voltage Regulator

Repair Circuit

Rectifier

Diode Trio

Diode

Tester

Diode

Diode Type	Part No.	Polarity	Amp	Reverse or Avalanche Voltage(V)	Reverse Leakage ($\mu\text{A}@ 25^\circ\text{C}$)	Diameter	Lead Type	Lead OD (mm)	Lead Length(mm)	
Bosch Press-Fit										
	DD-1020	-	25	400	4	12.8	Straight	1.3	29	
	DD-1021	+	25	400	4	12.8	Straight	1.3	29	
	DD-1022	-	35	400	4	12.8	Straight	1.3	29	
	DD-1023	+	35	400	4	12.8	Straight	1.3	29	
	DD-1024	-	50	400	4	12.8	Straight	1.3	29	
	DD-1025	+	50	400	4	12.8	Straight	1.3	29	
Bosch Press-Fit Avalanche										
	DD-1053	-	50	24 ~ 32	1	12.8	Straight	1.3	34	
	DD-1054	+	50	24 ~ 32	1	12.8	Straight	1.3	34	
Hitachi Press-Fit										
	DD-1055	-	25	400	4	11.5	Fork			
	DD-1056	+	25	400	4	11.5	Fork			
	DD-1115	-	35	400	4	11.5	Fork			
	DD-1116	+	35	400	4	11.5	Fork			
	DD-1117	-	50	400	4	11.5	Fork			
	DD-1118	+	50	400	4	11.5	Fork			
	DD-1065	-	25	400	4	11.5	Straight	1.5	20	
	DD-1066	+	25	400	4	11.5	Straight	1.5	20	
	DD-1059	-	40	400	4	11.5	Straight	1.5	20	
	DD-1060	+	40	400	4	11.5	Straight	1.5	20	
	DD-1067	-	50	400	4	11.5	Straight	1.5	20	
	DD-1068	+	50	400	4	11.5	Straight	1.5	20	
	Hitachi Press-Fit Avalanche									
	DD-1093	-	35	24 ~ 32	1	11.5	Straight	1.5	20	
	DD-1094	+	35	24 ~ 32	1	11.5	Straight	1.5	20	
	DD-1069	-	50	24 ~ 32	1	11.5	Straight	1.5	20	
DD-1070	+	50	24 ~ 32	1	11.5	Straight	1.5	20		
Lucas Press-Fit										
	DD-1119	-	25	400	4	10	Straight	1.3	29	
	DD-1120	+	25	400	4	10	Straight	1.3	29	
	DD-1038	-	35	400	4	10	Straight	1.3	29	
	DD-1039	+	35	400	4	10	Straight	1.3	29	
	DD-1121	-	50	400	4	10	Straight	1.3	29	
	DD-1122	+	50	400	4	10	Straight	1.3	29	
	Lucas Press-Fit Avalanche									
	DD-1105	-	35	24 ~ 32	1	10	Straight	1.3	29	
	DD-1106	+	35	24 ~ 32	1	10	Straight	1.3	29	
	DD-1107	-	50	24 ~ 32	1	10	Straight	1.3	29	
DD-1108	+	50	24 ~ 32	1	10	Straight	1.3	29		

Brush Holder

Voltage Regulator

Repair Circuit

Rectifier

Diode Trio

Diode

Tester

Diode

Diode Type	Part No.	Polarity	Amp	Reverse or Avalanche Voltage(V)	Reverse Leakage (μA@ 25°C)	Diameter	Lead Type	Lead OD (mm)	Lead Length(mm)	
Motorola Press-Fit										
	DD-1034	-	35	400	4	12.8	Straight	1.3	29.1	
	DD-1035	+	35	400	4	12.8	Straight	1.3	29.1	
	DD-1036	-	50	400	4	12.8	Straight	1.3	29.1	
	DD-1037	+	50	400	4	12.8	Straight	1.3	29.1	
	Motorola Press-Fit Avalanche									
	DD-1079	-	35	19 ~ 24	1	12.8	Straight	1.3	32.5	
	DD-1080	+	35	19 ~ 24	1	12.8	Straight	1.3	32.5	
	DD-1063	-	50	19 ~ 24	1	12.8	Straight	1.3	32.5	
	DD-1064	+	50	19 ~ 24	1	12.8	Straight	1.3	32.5	
	DD-1089	-	70	19 ~ 24	1	12.8	Straight	1.3	32.5	
	DD-1090	+	70	19 ~ 24	1	12.8	Straight	1.3	32.5	
DD-1077	-	35	24 ~ 32	1	12.8	Straight	1.3	32.5		
DD-1078	+	35	24 ~ 32	1	12.8	Straight	1.3	32.5		
DD-1047	-	50	24 ~ 32	1	12.8	Straight	1.3	32.5		
DD-1048	+	50	24 ~ 32	1	12.8	Straight	1.3	32.5		
Motorola Press-Fit Avalanche										
	DD-1083	-	70	24 ~ 32	1	12.8	Straight	1.3	32.5	
	DD-1084	+	70	24 ~ 32	1	12.8	Straight	1.3	32.5	
	DD-1091	-	50	32 ~ 40	1	12.8	Straight	1.3	32.5	
	DD-1092	+	50	32 ~ 40	1	12.8	Straight	1.3	32.5	
	DD-1087	-	70	32 ~ 40	1	12.8	Straight	1.3	32.5	
	DD-1088	+	70	32 ~ 40	1	12.8	Straight	1.3	32.5	

- Brush Holder
- Voltage Regulator
- Repair Circuit
- Rectifier
- Diode Trio
- Diode
- Tester

INTRODUCING OUR BRAND NEW COM TESTER!

VOLTAGE REGULATOR TESTER



Reduce costs for
BSS / LIN and RVC
regulator testing

Portable handheld tester with an intuitive interface and easy to read display.

Ability to test both RVC and COM regulators.

- Including both BSS and LIN protocols up to and inclusive of LIN 2.0.









Works with all COM regulators of Bosch, Denso, Mitsubishi and Valeo.

Several preset duty cycles for RVC regulators that can be selected to test the varying output voltage.

Provides error codes for both RVC and COM regulators to give you the most accurate test results.

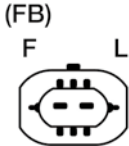



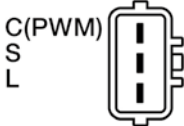

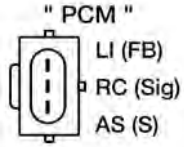

Can be used alongside a VRT-10 or ALT-98 tester.

Voltage Regulator Tester

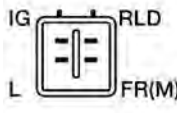
Mobiletron No.	Description	Apply to
<p>VR-COM02</p> 	<p>*Used on new generation of COM products *Automatic identification in COM products</p>	
<p>VR-COM01</p> 	<p>*Used on new generation of COM products</p>	<p>VR-B280/B385/B285/B880 VR-B379/B885/B150/B056/B092 VR-B020/B021/B033/B131/B132 VR-H2005-171/178 VR-H2009-160/164/171 VR-V3780/V2975/V3231/V4291/V2604 VR-V3796/V4114/V2263/V010/V3279</p>
<p>VR-RVC01</p> 	<p>*Used on RVC function voltage regulator</p>	<p>VR-F156/F822/F910 VR-VN001 VR-PR4920 VR-V5460/V0441/V9938/V3530 VR-H2005-88/96/101/163 VR-H2000-73/89/91 VR-H2009-98/130/140/145 VR-H2009-173/172/199/206 VR-B3102 VR-D583/D755</p>
<p>10810216</p> 	<p>*Test lead for VR-RVC01 *Used on GM RVC function voltage regulator</p> 	<p>VR-H2005-101/163 VR-D583/D186/D755 VR-B3102 VR-V5460</p>
<p>10810263</p> 	<p>*Test lead for VR-RVC01 *Used on RVC function voltage regulator</p> 	<p>VR-H2005-142 VR-H2005-150</p>
<p>10810269</p> 	<p>*Test lead for VR-RVC01 *Used on RVC function voltage regulator</p> 	<p>VR-H2000-73/89/91 VR-H2009-130/145 VR-V0447</p>

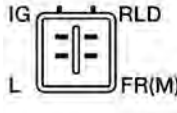
- Brush Holder
- Voltage Regulator
- Repair Circuit
- Rectifier
- Diode Trio
- Diode
- Tester

Voltage Regulator Tester

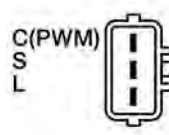
Mobiletron No.	Description	Apply to
10810214 	*Test lead for VR-RVC01 *Used on RVC function voltage regulator 	VR-F910 VR-F156 VR-VN001 VR-H2009-98 VR-H2009-102 VR-H2009-140
VR-RVC01W 	*Test lead for VR-RVC01 	VR-H2005-95 VR-H2005-199
PL-ALT9805 	*Test lead for ALT-98 *Used on LIN 1 B type voltage regulator	VR-B112 VR-V2988 VR-H2005-156 VR-H2005-210 VR-H2005-206 VR-H2005-214 VR-H2005-215
PL-RLO482 	*Test lead for ALT-98 	VR-H2005-95 VR-H2005-199
PL-RVC468 	*Test lead for ALT-98 	VR-H2005-212 VR-V3530/V9938/V7052/V018
PL-RVC9151 	*Test lead for ALT-98 	VR-H2000-3/89/91 VR-H2009-130/145 VR-V0447

Brush Holder

Voltage Regulator

Repair Circuit

Rectifier

Diode Trio

Diode

Tester